

ENTRY

executive collection



PR
OF

ENTRY

executive collection



**PR
OF**

« CONTENTS »

PAG. 04
CHAPTER 01 - THE COLLECTION

PAG. 12
CHAPTER 02 - THE CATALOGUE

PAG. 14
CHAPTER 03 - PROJECT 01

PAG. 24
CHAPTER 04 - PROJECT 02

PAG. 34
CHAPTER 05 - PROJECT 03

PAG. 42
CHAPTER 06 - PROJECT 04

PAG. 54
CHAPTER 07 - PROJECT 05

PAG. 64
CHAPTER 08 - PROJECT 06

PAG. 72
CHAPTER 10 - TECHNICALS





« THE COLLECTION »

IT — Dal design essenziale ispirato a linee semplici, Entry è una collezione direzionale di scrivanie e tavoli riunione che risponde alle esigenze di uno spazio di lavoro flessibile, interpretando ambientazioni differenti grazie all'ampia varietà di colori e finiture. La SCRIVANIA è caratterizzata da una struttura e un piano in legno disponibile in melaminico, laccato antigraffio extra opaco soft-touch, Fenix NTM® e impiallacciato. È prevista la configurazione semplice e quella con piano dattilo. I TAVOLI RIUNIONE rettangolari e sagomati sono previsti in varie profondità e possono essere composti in configurazioni modulari.

EN — With an essential design inspired by simple lines, Entry is a executive collection of desks and meeting tables that meets the needs of a flexible workspace, featuring different settings thanks to the wide variety of colours and finishes. The DESK is characterized by a wooden structure and top available in melamine, scratch-resistant soft-touch extra matt lacquered, Fenix NTM® and veneered. There is a simple configuration and the one with an extension top. Rectangular and shaped MEETING TABLES are available in various widths and can be composed in modular configurations.

F — Avec un design essentiel inspiré de lignes simples, Entry est une collection directionnelle de bureaux et de tables de réunion qui répond aux besoins d'un espace de travail flexible, interprétant différents décors grâce à la grande variété de couleurs et de finitions. Le BUREAU se caractérise par une structure et un plateau en bois disponible en mélamine, en laqué extra mat résistant aux rayures soft-touch, en Fenix NTM® et en placage. Il y a une configuration simple et celle avec un plateau retour. Les TABLES DE RÉUNION rectangulaires et de forme sont disponibles en différentes profondeurs et peuvent être composés en configurations modulaires.

DESK

IT— Essenziale e funzionale, la scrivania è prevista tutta in legno con un gioco di tonalità a contrasto. Per un effetto monocromatico è possibile scegliere la versione in colore unico.

EN— Essential and functional, the desk is made entirely of wood with a play of contrasting shades. For a monochromatic effect, it is possible to choose the version in a single colour.

F— Essentiel et fonctionnel, le bureau est entièrement réalisé en bois avec un jeu de couleurs contrastées. Pour un effet monochrome il est possible de choisir la version en une seule couleur.

**DESK + EXTENSION**

IT— Con una gamba speciale dedicata, la scrivania viene proposta in versione con dattilo, che funge da comoda estensione del piano di lavoro.

EN— With a special dedicated leg, the desk comes in an extension version, which acts as a comfortable extension of the worktop.

F— Avec un pied spécial dédié, le bureau existe en version avec retour, qui agit comme une extension confortable du plan de travail.



MEETING TABLE

IT— I tavoli riunione rettangolari sono proposti in tre profondità e due lunghezze e possono essere canalizzati con passacavo Profcable con sportello in finitura con il piano.

EN— Rectangular meeting tables are available in three depths and two lengths and can be channeled with Profcable cable tidy with flip top in the same finish as the top.

F— Les tables de réunion rectangulaires sont disponibles en trois profondeurs et deux longueurs et peuvent être canalisées avec le passe câble Profcable avec top en finition du dessus.

MODULAR MEETING TABLE

IT— Possono essere composti in varie configurazioni modulari, con gamba centrale condivisa.

EN— They can be composed in various modular configurations, with shared central leg.

F— Ils peuvent être composés selon diverses configurations modulaires, avec un pied central commun.



MEETING TABLE

IT— I tavoli riunione sagomati sono proposti in tre profondità e due lunghezze e possono essere canalizzati con passacavo Profcable con sportello in finitura con il piano.

EN— The shaped meeting tables are available in three depths and two lengths and can be channeled with Profcable cable tidy with flip top in the same finish as the table top.

F— Les tables de réunion en formes sont disponibles en trois profondeurs et deux longueurs et peuvent être canalisées avec le passe-câble Profcable avec top en finition du dessus.

MODULAR MEETING TABLE

IT— Possono essere composti in varie configurazioni modulari, con gamba centrale condivisa.

EN— They can be composed in various modular configurations, with shared central leg.

F— Ils peuvent être composés selon diverses configurations modulaires, avec un pied central commun.





« THE CATALOGUE »

IT— Il catalogo illustra la collezione direzionale Entry attraverso sei progetti che comprendono scrivanie, tavoli riunione e aree attese. Un'ampia photogallery di immagini ambientate per nuove ispirazioni e un'accurata sezione tecnica con disegni e descrizioni sul prodotto e sui materiali. Completano gli ambienti i contenitori Profbox, le librerie Profcase, le lampade Grace e tutti i complementi della collezione Profmood, che consentono di formulare progetti d'arredo sempre più personalizzati, perfettamente abbinati nei materiali e nei colori.

EN— The catalogue illustrates the Entry executive collection through six projects including desks, meeting tables and waiting areas. An extensive photogallery of images set for new inspirations and an accurate technical section with drawings and descriptions of the product and materials. The rooms are completed by Profbox cabinets, Profcase bookcases, Grace lamps and all the complements of the Profmood collection, which make it possible to formulate increasingly personalized furnishing projects, perfectly matched in materials and colours.

F— Le catalogue illustre la collection des cadres de l'Entry à travers six projets comprenant des bureaux, des tables de réunion et des salles d'attente. Une vaste galerie d'images pour de nouvelles inspirations et une section technique précise avec des dessins et des descriptions du produit et des matériaux. Les pièces sont complétées par des armoires Profbox, des librairies Profcase, des lampes Grace et tous les accessoires de la collection Profmood, qui permettent de formuler des projets d'ameublement de plus en plus personnalisés, parfaitement assortis dans les matériaux et les couleurs.

Project 01

rovere natural / nero
 natural oak / black
 chêne naturel / noir

IT— La scrivania è proposta con piano in melaminico rovere natural, dattilo e gonna in finitura laccato antigraffio extra opaco soft-touch nero. Nelle stesse tonalità, sono abbinati una cassettera su ruote e un contenitore Profbox con ante e vani a giorno. Il tavolo riunione è in finitura melaminico rovere natural accompagnato da due contenitori Profbox in nero e rovere natural.

EN— The desk is available with a top in natural oak melamine, black scratch-resistant extra matt soft-touch lacquered extension and modesty panel. In the same colours, a pedestal drawers unit on castors and a Profbox with doors and open compartments are combined. The meeting table is in natural oak melamine finish accompanied by two Profbox cabinets in black and natural oak.

F— Le bureau est disponible avec un plateau en mélamine de chêne naturel, un retour et voile de fond en finition laquée extra mat résistant aux rayures soft-touch noire. Dans les mêmes couleurs, une caisson tiroirs sur roulettes et un Profbox avec portes et compartiments ouverts sont combinés. La table de réunion est en mélamine de chêne naturel, accompagnée de deux conteneurs Profbox en noir et chêne naturel.





DESK — 2440 x 2000 x H 750 mm



DRAWERS UNIT — 332 x 600 x H 520 mm



PROFBOX — 1540 x 470 x H 1284 mm

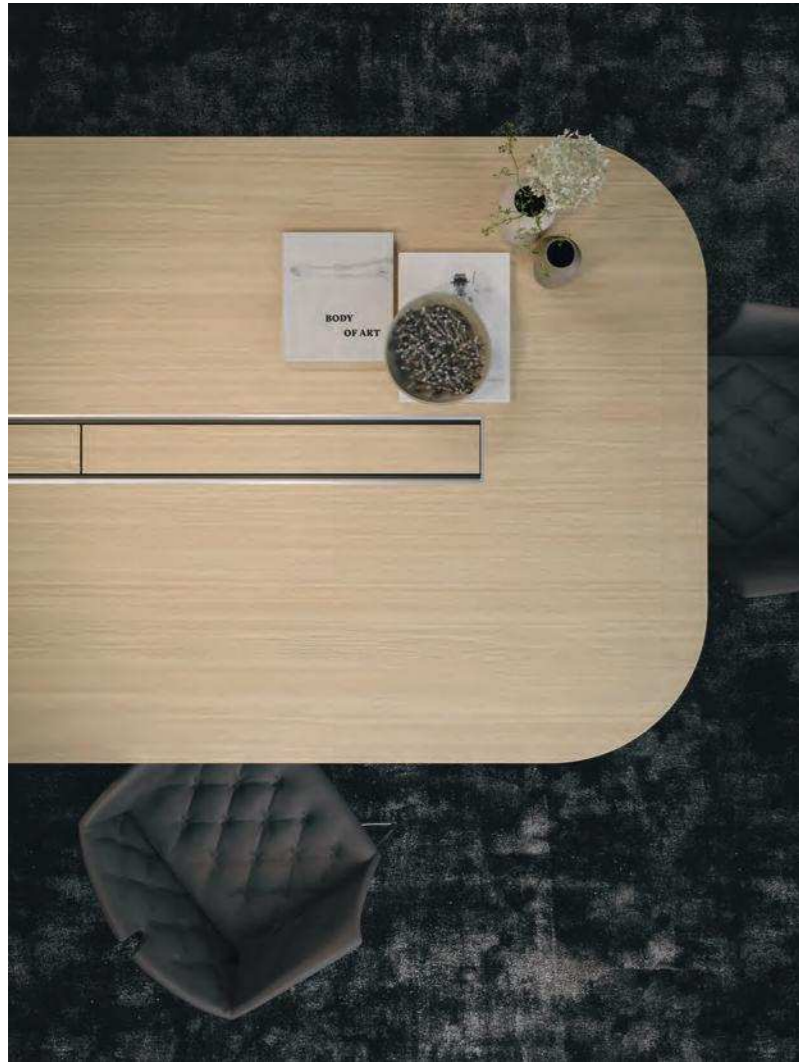

MEETING TABLE — 2800 x 1400 x H 750 mm





PROFBOX — 1239 x 470 x H 1284 mm



COFFEE TABLES — 800 x 400 x H 400 mm
500 x 500 x H 450 mm

Project 02

rame / verde bosco
copper / forest green
cuivre / vert forêt

IT— La scrivania è proposta interamente laccata antigraffio extra opaco soft-touch nelle tonalità rame e verde bosco. È attrezzata con un comodo cassetto sotto piano abbinato in tinta. Versatile e funzionale, la accompagna un mobile contenitore Profbox con ante ad apertura push to open in finitura laccato antigraffio extra opaco soft-touch color verde bosco. Il tavolo riunione rettangolare è in unica finitura laccato antigraffio extra opaco soft-touch rame, come il contenitore Profbox nel fondo con ante ad apertura push to open.

EN— The desk is proposed entirely scratch-resistant extra matt soft-touch lacquered in copper and forest green tones. It is equipped with a comfortable under-top drawer matching the colour. Versatile and functional, it is accompanied by a Profbox cabinet with push to open doors in forest green scratch-resistant extra matt soft-touch lacquered. The rectangular meeting table is in a single scratch-resistant extra matt soft-touch lacquered in copper finish, like the Profbox cabinet in the bottom with push to open doors.

F— Le bureau est proposé entièrement laqué extra mat résistant aux rayures soft-touch dans des nuances de cuivre et vert forêt. Il est équipé d'un confortable tiroir sous le comptoir, de la même couleur. Polyvalente et fonctionnelle, elle s'accompagne d'une unité de rangement Profbox avec portes à ouverture par poussée, dans une finition laqué extra mat résistant aux rayures soft-touch de couleur vert forêt. La table de réunion rectangulaire est dotée d'une seule finition laquée extra mate résistante soft-touch en cuivre, comme l'unité de rangement Profbox dans le fond avec des portes à pousser pour ouvrir.







DESK — 2240 x 1000 x H 750 mm



PROFBOX — 1840 x 470 x H 1284 mm



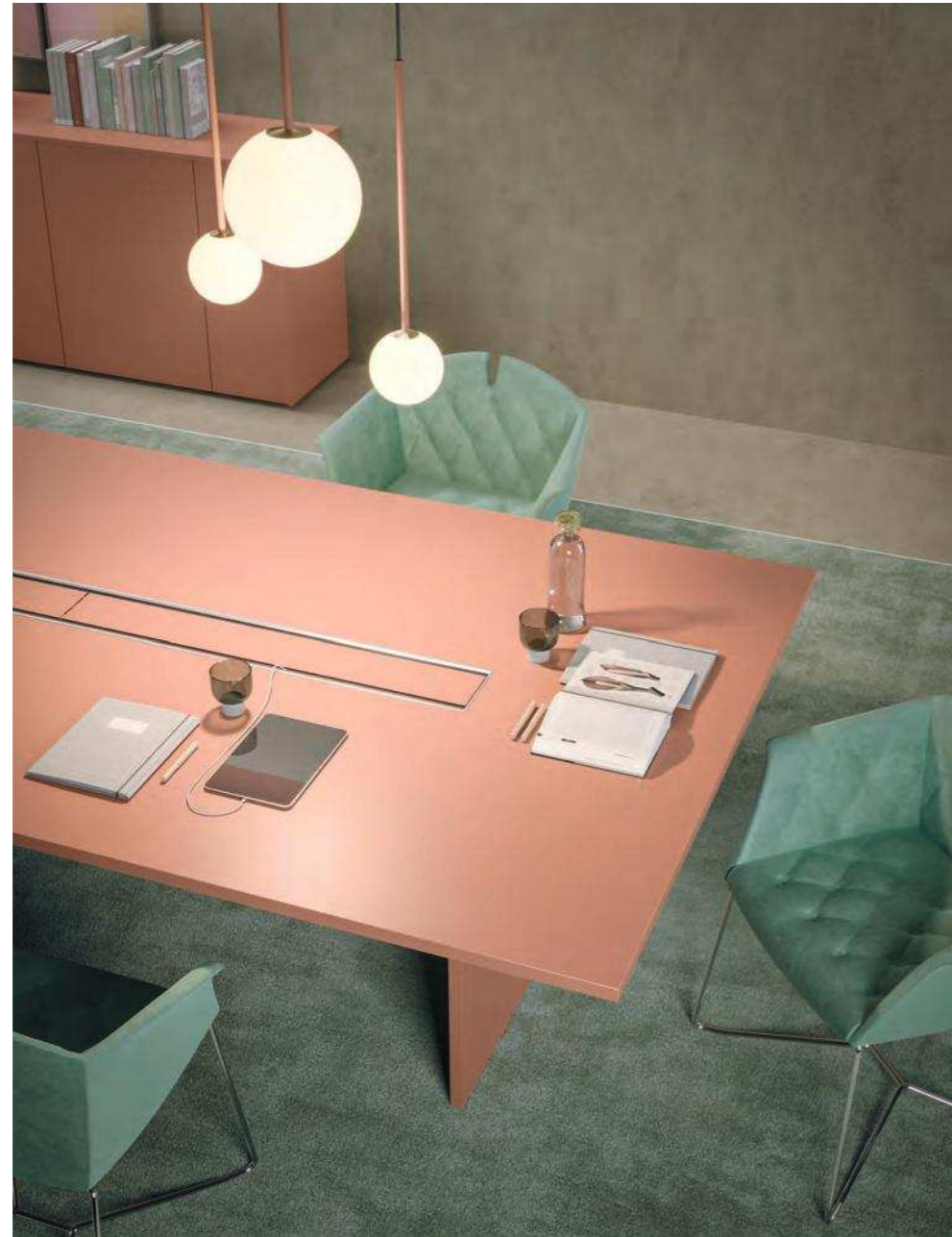

MEETING TABLE — 2800 x 1400 x H 750 mm



PROFBOX — 1840 x 470 x H 868 mm

Project 03

noce dark / rosso rubino
dark walnut / ruby red
noyer foncé / rouge rubis

IT— La scrivania è presentata con piano in melaminico noce dark, dattilo e gonna in laccato antigraffio extra opaco soft-touch rosso rubino. Comodo e funzionale, posizionato sotto il dattilo, un mobile di servizio con ante, cassetti e vassoio superiore. Nel fondo un contenitore Profbox proposto nelle stesse tonalità, con vani a giorno ed ante con maniglie in tinta. Il tavolo riunione rettangolare modulare è in unica finitura melaminico noce dark. Lo accompagnano due mobili Profbox in finitura laccato antigraffio extra opaco soft-touch rosso rubino con maniglie abbinata.

EN— The desk is shown with a dark walnut melamine top, ruby red scratch-resistant extra matt soft-touch lacquered top extension and modesty panel. Comfortable and functional, positioned under the top extension, a service unit with doors, drawers and upper tray. In the bottom there is a Profbox cabinet proposed in the same colours, with open compartments and doors with matching handles. The modular rectangular meeting table is in a unique dark walnut melamine finish. It is accompanied by two Profbox cabinets in ruby red scratch-resistant extra matt soft-touch lacquered with matching handles.

F— Le bureau est présenté avec un plateau en mélamine noyer foncé, un retour et voile de fond laquée extra mat résistant aux rayures soft-touch rouge rubis. Confortable et fonctionnel, placé sous le retour, un meuble de service avec portes, tiroirs et plateau supérieur. Dans le fond, il y a un conteneur Profbox proposé dans les mêmes couleurs, avec des compartiments ouverts et des portes avec des poignées assorties. La table de réunion rectangulaire modulaire est réalisée dans une finition unique en mélamine noyer foncé. Il est accompagné de deux armoires Profbox en finition laquée extra mat résistant aux rayures soft-touch rouge rubis avec poignées assorties.





DESK — 2240 x 2000 x H 750 mm



SERVICE UNIT — 880 x 360 x H 542 mm



PROFBOX — 2440 x 470 x H 1284 mm



PROFBOX — 1838 x 470 x H 1284 mm

Project 04

beige / basalto / rosso oriente
 beige / basalt / orient red
 beige / basalte / rouge orient

IT— La scrivania con dattilo è presentata in versione laccata antigraffio extra opaco soft-touch nelle tonalità beige e basalto. Negli stessi colori, la cassetiera su ruote a larghezza ridotta e vassoio superiore. Nel fondo, due mobili Profbox con vani a girone e ante colorate in melaminico beige e rosso oriente. Rigore geometrico per il tavolo riunione rettangolare interamente in laccato antigraffio extra opaco soft-touch beige. Abbinato nei colori melaminico beige e rosso oriente, il contenitore Profbox con ante push to open e vani a giorno. I tavoli caffè sono proposti negli stessi colori melaminici beige, basalto e rosso oriente in varie misure.

EN— The desk with extension is proposed in scratch-resistant extra matt soft-touch lacquered version in beige and basalt. In the same colours, the pedestal drawers unit on castors with reduced width and upper tray. At the bottom, two Profbox cabinets with open compartments and coloured doors in beige and orient red melamine. Geometric rigour for the rectangular meeting table entirely in beige scratch-resistant extra matt soft-touch lacquered. Combined in beige and orient red melamine, the Profbox cabinet with push to open doors and open compartments. The coffee tables are available in the same melamine colours beige, basalt and orient red in various sizes.

F— Le bureau avec retour est présenté dans une version laqué extra mat résistant aux rayures soft-touch en beige et basalte. Dans les mêmes couleurs, le cassoïn sur roulettes à largeur réduite et le plateau supérieur. En bas, deux armoires Profbox avec des compartiments ouverts et des portes colorées en mélamine beige et rouge orient. Rigueur géométrique pour la table de réunion rectangulaire entièrement en laqué extra mat résistant aux rayures soft-touch beige. Combiné en mélamine beige et rouge orient, le rangement Profbox avec portes et compartiments à pousser. Les tables basses sont disponibles dans les mêmes couleurs de mélamine: beige, basalte et rouge orient dans différentes mesures.





DESK — 2240 x 2000 x H 750 mm



DRAWERS UNIT — 332 x 600 x H 520 mm



PROFBOX — 1241 x 470 x H 1284 mm





PROFBOX — 2444 x 470 x H 868 mm

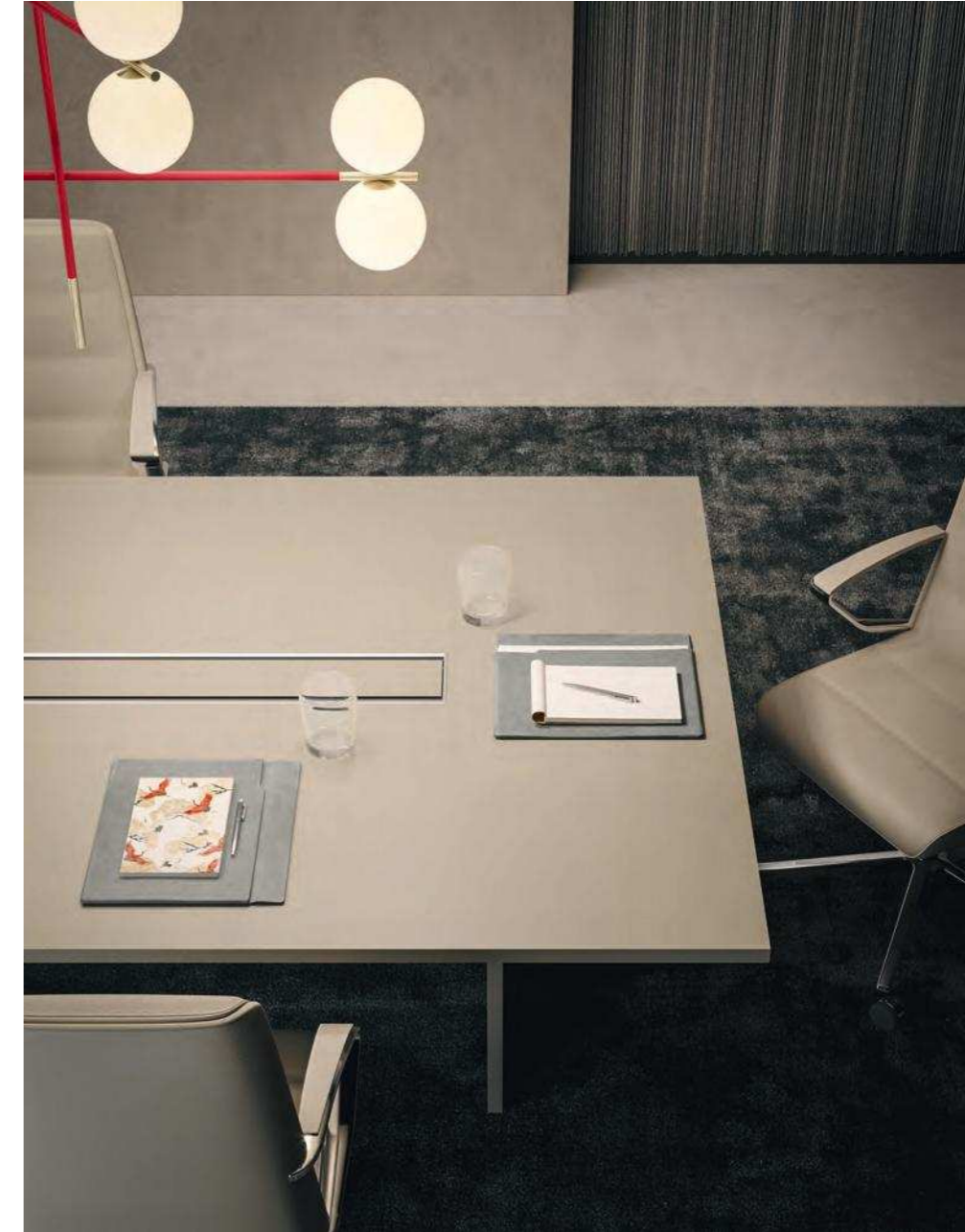

MEETING TABLE — 2800 x 1400 x H 750 mm



COFFEE TABLES — 600 x 600 x H 400 mm



COFFEE TABLES — 800 x 400 x H 400 mm
500 x 500 x H 450 mm

Project 05

grigio chiaro / verde oliva / basalto
 light grey / olive green / basalt
 gris clair / vert olive / basalte

IT— La scrivania è proposta in versione laccata con piano grigio chiaro, dattilo e gonna verde oliva. Sotto il dattilo trova posto un mobile di servizio in finiture melaminico verde oliva. Nel fondo un mobile Profbox con vani a giorno e ante colorate in melaminico grigio chiaro, verde oliva e basalto. Il tavolo riunione sagomato modulare è in unica finitura laccato antigraffio extra opaco soft-touch grigio chiaro, come la libreria Profcase con inserti basalto e ferma libri curry.

EN— The desk is available in a lacquered version with a light grey top, olive green extension and modesty panel. Under the extension top a service unit in olive green melamine finish finds place. In the bottom there is a Profbox cabinet with open compartments and coloured doors in light grey, olive green and basalt melamine. The modular shaped meeting table is in a single light grey scratch-resistant extra matt soft-touch lacquered finish, as the Profcase bookcase with basalt inserts and curry bookstops.

F— Le bureau est disponible en version laquée avec un plateau gris clair, un retour et voile de fond vert olive. Sous le retour se trouve une meuble de service en mélamine vert olive. En bas, il y a une armoire Profbox avec des compartiments ouverts et des portes colorées en mélamine gris clair, vert olive et basalte. La table de réunion en forme modulaire est en laqué extra mat résistant aux rayures soft-touch gris clair, comme la bibliothèque Profcase avec des inserts en basalte et des serre-livres livres en curry.





DESK — 2240 x 2000 x H 750 mm



PROFBOX — 1842 x 470 x H 1284 mm





MEETING TABLE — 4400 x 1400 x H 750 mm



PROFCASE — 3744 x 340 x H 2144 mm

Project 06

bianco / beige
white / beige
blanc / beige

IT— La scrivania è presentata in versione laccata con piano bianco, dattilo e gonna beige. È accompagnata da una cassetiera su ruote con vassoio e nel fondo da due contenitori Profbox con ante push to open e vani a giorno tutti giocati nelle finiture abbinare melaminico bianco e beige.

EN— The desk is presented in a lacquered version with white top, beige extension and modesty panel. It is accompanied by a pedestal drawers unit on castors with tray and in the bottom by two Profbox cabinets with push to open doors and open compartments all played in matching white and beige melamine finishes.

F— Le bureau est présenté dans une version laquée avec un plateau blanc, un retour et voile de fond beige. Elle est accompagnée d'une caisse sur roulettes avec plateau et dans le fond de deux conteneurs Profbox avec portes à pousser et compartiments à ouvrir, le tout joué dans des finitions assorties en mélamine blanche et beige.







DESK — 2240 x 2000 x H 750 mm



DRAWERS UNIT — 332 x 600 x H 520 mm



PROFBOX — 2142 x 470 x H 868 mm



« TECHNICALS »

IM - IMPIALLACCIATO LEGNO / WOOD VENEER / PLAQUÉ BOIS



44
noce Canaletto
walnut Canaletto
noyer Canaletto

50
rovere termotrattato
thermotreated oak
chêne traité thermiquement

FX - FENIX NTM® / FENIX NTM® / FENIX NTM®

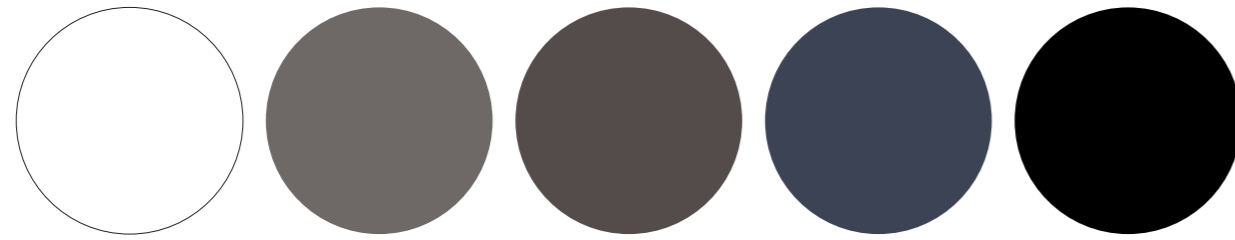

0032
bianco
white
blanc

0717
castoro
beaver
castor

0749
cacao
cocoa
cacao

0754
blu scuro
dark blue
bleu foncé

0720
nero
black
noir

ME - MELAMINICO / MELAMINE / MÉLAMINÉ



71
rovere natural
natural oak
chêne naturel

75
noce natural
natural walnut
noyer naturelle

77
noce dark
dark walnut
noyer foncé

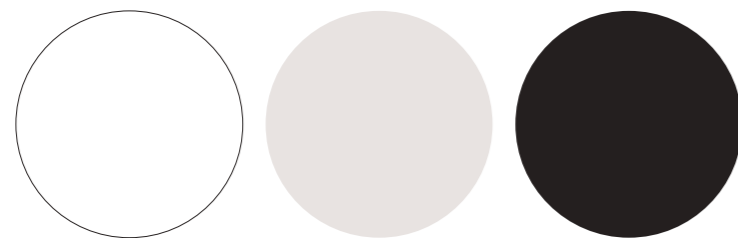

20
bianco
white
blanc

01
grigio chiaro
light grey
gris clair

04
nero
black
noir

MC - COLORE MELAMINICO / MELAMINE COLOR / COULEUR MÉLAMINÉE

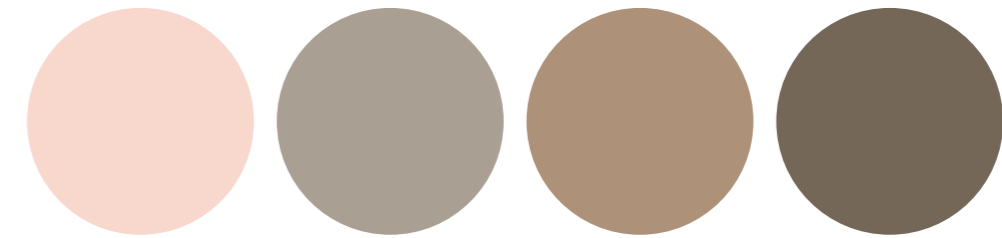

31
cipria
powder
poudre

26
beige
beige
beige

23
cappuccino
cappuccino
cappuccino

25
tabacco
tobacco
tabac

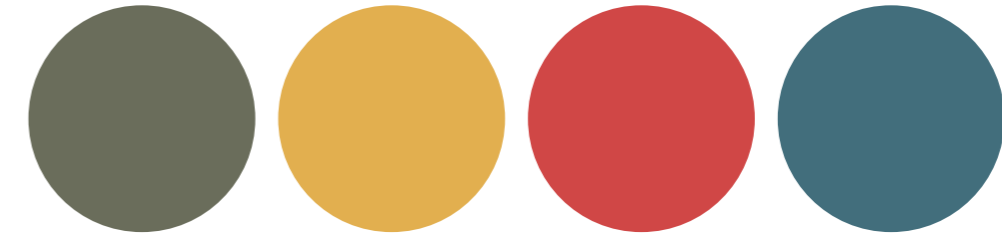

24
verde oliva
olive green
vert olive

32
curry
curry
curry

29
rosso oriente
orient red
rouge orient

33
petrolio
petroleum
pétrole



34
grigio perla
pearl grey
gris perle

30
basalto
basalt
basalte

35
blu sea
blue sea
mer bleue

OS - ALLUMINIO OSSIDATO / OXIDIZED ALUMINIUM / ALUMINIUM OXYDÉ



B7S
ottone spazzolato
brushed brass
laiton brossé

ASC
alluminio spazzolato
brushed aluminum
aluminium brossé

E8S
nero spazzolato
brushed black
noir brossé

LO - LACCATO OPACO / MATT LACQUERED / LAQUÉ MAT

LA - LACCATO ANTIGRAFFIO EXTRA OPACO SOFT-TOUCH
 SCRATCH-RESISTANT SOFT-TOUCH EXTRA MATT LACQUERED
 LAQUÉ EXTRA MAT RÉISTANT AUX RAYURES SOFT-TOUCH

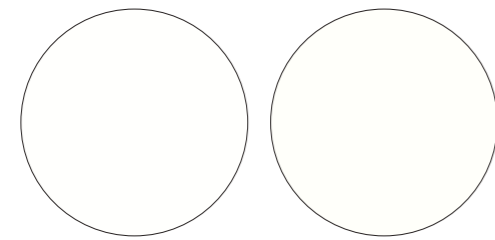

9016
 bianco neve
 snow white
 blanche neige

9010
 bianco
 white
 blanc

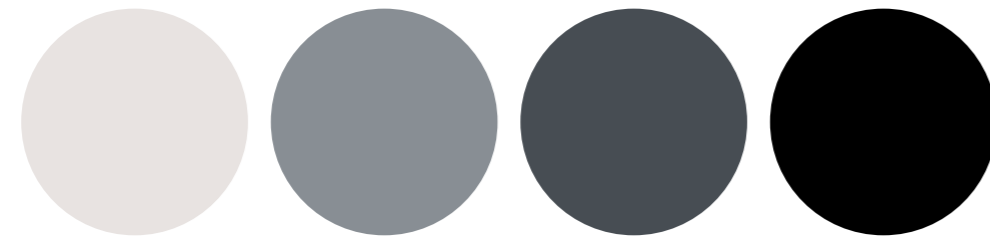

1500
 grigio chiaro
 light grey
 gris clair

4500
 grigio perla
 pearl grey
 gris perle

7500
 basalto
 basalt
 basalte

9005
 nero
 black
 noir

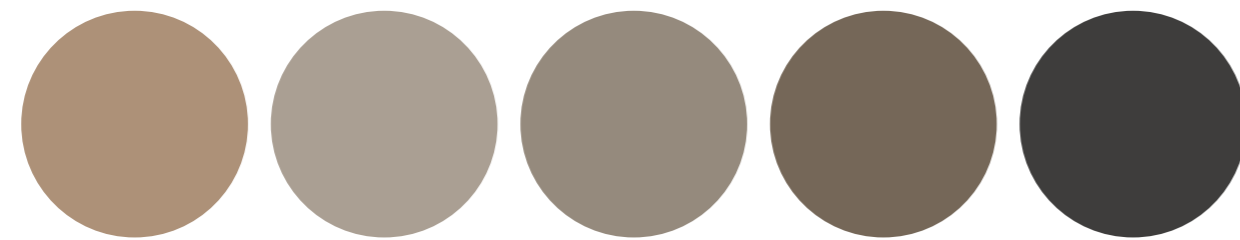

3010
 cappuccino
 cappuccino
 cappuccino

3005
 beige
 beige
 beige

7048
 castoro
 beaver
 castor

6005
 tabacco
 tobacco
 tabac

7502
 cacao
 cocoa
 cacao

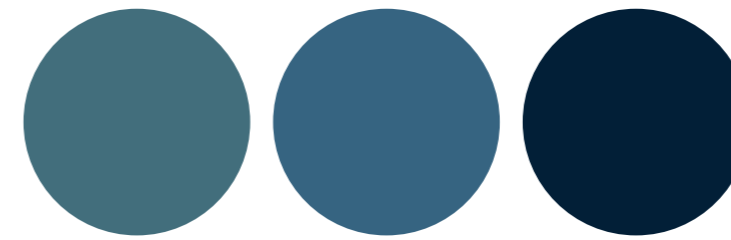

5020
 petrolio
 petroleum
 huile

6020
 blu sea
 blue sea
 mer bleue

5011
 blu scuro
 dark blue
 bleu foncé

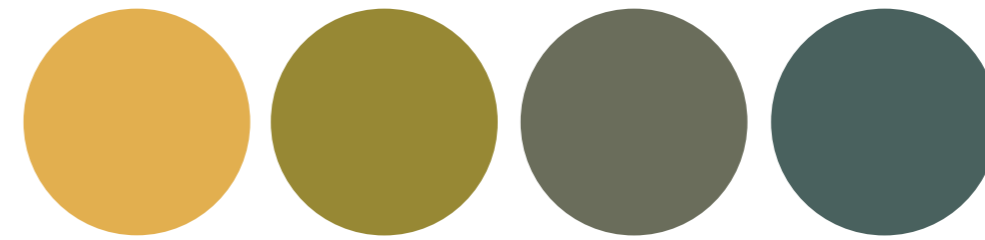

2060
 curry
 curry
 curry

4050
 verde pistacchio
 pistachio green
 vert pistache

6010
 verde oliva
 olive green
 vert olive

7010
 verde bosco
 forest green
 vert forêt

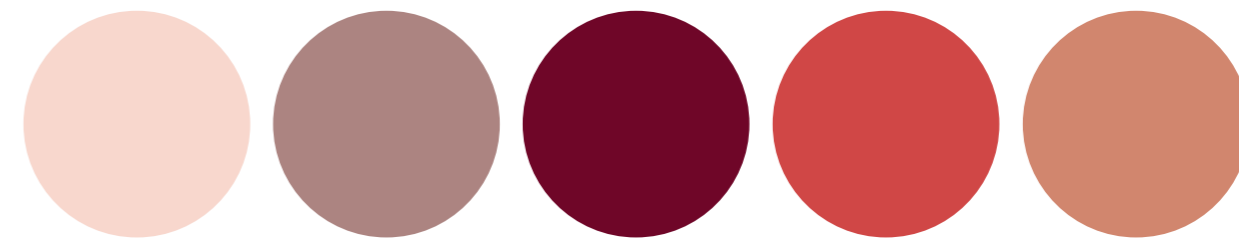

1510
 cipria
 powder pink
 poudre

4020
 desert rose
 desert rose
 desert rose

3004
 rosso rubino
 ruby red
 rouge rubis

2070
 rosso oriente
 orient red
 rouge orient

3012
 rame
 copper
 cuivre



SCRIVANIA
DESK
BUREAU

IT— La scrivania ha una struttura in legno con gonna disponibile in melaminico e laccato antigraffio extra opaco soft-touch. Il piano e la gamba in legno possono essere in melaminico, laccato antigraffio extra opaco soft-touch, Fenix NTM® e impiallacciato con spessore di 27/28/29 mm.

EN— The desk has a wooden structure with modesty panel available in melamine and scratch-resistant soft-touch extra matt lacquered. The wood top and modesty panel can be in melamine, scratch-resistant soft-touch extra matt lacquered, Fenix NTM® and wood veneer with a thickness of 27/28/29 mm.

F— Le bureau a une structure avec une voile de fond en bois disponibles en mélamine et laqués extra-mat résistant aux rayures soft-touch. Le plateau et le voile de fond peuvent être en bois de mélamine, en laqué extra-mat résistant aux rayures soft-touch, en Fenix NTM® et en placage d'une épaisseur de 27/28/29 mm.

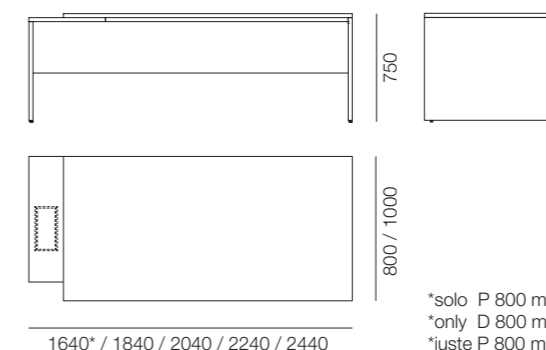

SCRIVANIA + DATILO
DESK + EXTENSION
BUREAU + RETOUR

IT— La scrivania ha una struttura in legno con gonna e con una gamba speciale che funge da piano dattilo disponibile in melaminico e laccato antigraffio extra opaco soft-touch. Il piano e la gamba in legno possono essere in melaminico, laccato antigraffio extra opaco soft-touch, Fenix NTM® e impiallacciato con spessore di 27/28/29 mm.

EN— The desk has a wooden structure with modesty panel and with special leg that acts as a extension top available in melamine and scratch-resistant soft-touch extra matt lacquered. The wood top and modesty panel can be in melamine, scratch-resistant soft-touch extra matt lacquered, Fenix NTM® and wood veneer with a thickness of 27/28/19 mm.

F— Le bureau a une structure avec voile de fond en bois et avec a un pied spécial qui fait de plateau retour disponibles en mélamine et laqués extra-mat résistant aux rayures soft-touch. Le plateau et le voile de fond peuvent être en bois de mélamine, en laqué extra-mat résistant aux rayures soft-touch, en Fenix NTM® et en placage d'une épaisseur de 27/28/19 mm.





CASSETTO SMART TRAY
SMART TRAY DRAWER
TIROIR SMART TRAY

IT— La scrivania può essere attrezzata con un cassetto sottopiano metallico con serratura, disponibile nei colori metallici a catalogo.

EN— The desk can be equipped with a metal undertop drawer with lock, available in the metallic colours in the catalogue.

F— Le bureau peut être équipé d'un tiroir inférieur en métal avec serrure, disponible dans les couleurs métallisées du catalogue.

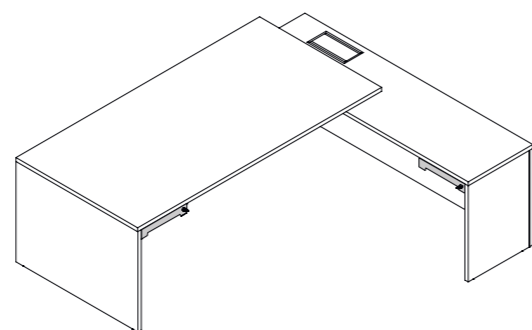

PORTA CPU
CPU HOLDER
PORTE CPU

IT— La scrivania può essere attrezzata con un porta cpu metallico sospeso fissato alla gamba destra o sinistra.

EN— The desk can be equipped with a suspended metal cpu holder fixed to the right or left leg.

F— Le bureau peut être équipé d'un support métallique suspendu pour ordinateur, fixé au pied droite ou gauche.

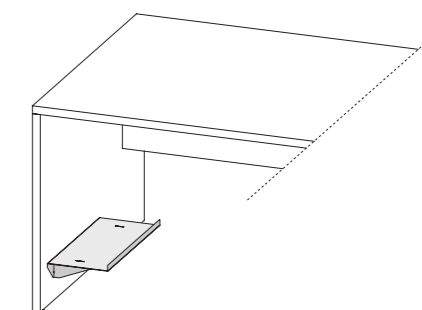

CANALIZZAZIONE SCRIVANIE
DESKS CABLING SYSTEM
CANALISATION BUREAUX

IT— Il piano può avere un passacavo Profcable in finitura anodizzata o verniciato con sportello apribile in tinta con il piano.

EN— The top can have a Profcable cable tidy in anodized or painted finish with an openable door in the same color as the top.

F— Le plateau peut avoir un passe-câble Profcable en aluminium anodisé or peint avec une porte ouvrable de la même couleur que le plateau.

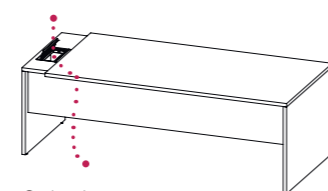

Scrivanìa
 Desk
 Bureau

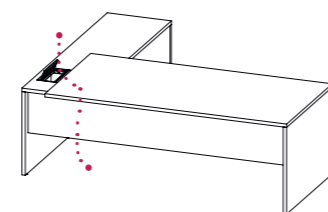

Scrivanìa + dattilo
 Desk + extension
 Bureau + retour

CANALIZZAZIONE TAVOLI RIUNIONE
MEETING TABLES CABLING SYSTEM
CANALISATION TABLES DE RÉUNION

IT— Il piano può avere un passacavo Profcable rettangolare in finitura anodizzata o verniciato con sportello apribile in tinta con il piano.

EN— The top can have a rectangular Profcable cable tidy in anodized or painted finish with an openable door in the same color as the top.

F— Le plateau peut comporter un passe-câble Profcable rectangulaire en aluminium anodisé or peint avec une porte ouvrable de la même couleur que le plateau.

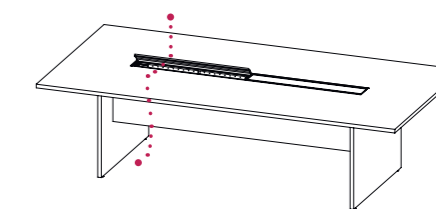

Tavolo riunione rettangolare
 Rectangular meeeting table
 Table de réunion rectangulaire

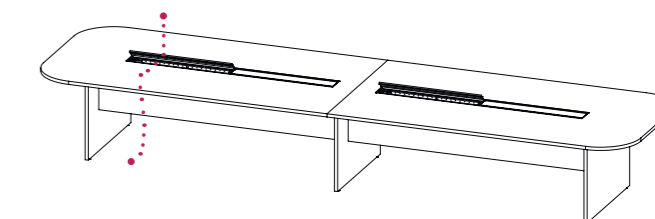

Tavolo riunione sagomato modulare
 Modular shaped meeeting table
 Table de réunion en forme modulaire



CASSETTIERA SU RUOTE
PEDESTAL DRAWERS UNIT ON CASTORS
CAISSON TIROIRS SUR ROULETTES

IT— Cassettiera su ruote con tre cassetti e serratura. È disponibile in legno melaminico, laccato antigraffio extra opaco soft-touch, Fenix NTM® e impiallacciato.

EN— Pedestal three drawers unit on castors with lock. It is available in melamine, scratch-resistant soft-touch extra matt lacquered, Fenix NTM® and wood veneer.

F— Caisson tiroirs sur roulettes avec trois tiroirs et serrure. Il est disponible en mélamine, laqué extra mat résistant aux rayures soft-touch, Fenix NTM® et plaqué bois.

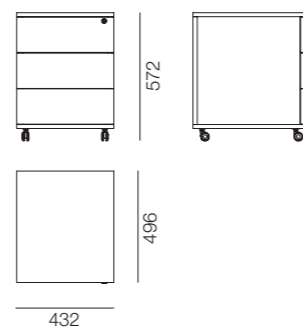

CASSETTIERA SU RUOTE
PEDESTAL DRAWERS UNIT ON CASTORS
CAISSON TIROIRS SUR ROULETTES

IT— Cassettiera su ruote con due cassetti, serratura e vassoio porta oggetti. È disponibile in legno melaminico, laccato antigraffio extra opaco soft-touch, Fenix NTM® e impiallacciato.

EN— Pedestal two drawers unit on castors with lock and vassoio porta oggetti. It is available in melamine, scratch-resistant soft-touch extra matt lacquered, Fenix NTM® and wood veneer.

F— Tiroir à roulettes avec deux tiroirs, serrure et plateau pour objets. Il est disponible en mélamine, laqué extra mat résistant aux rayures soft-touch, Fenix NTM® et plaqué bois.

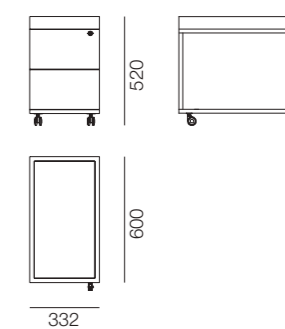

SERVETTO
SERVICE UNIT
MEUBLE DE SERVICE

IT— Mobile di servizio disponibile su ruote o fisso con vassoio superiore, anta e due cassetti push to open. È disponibile in legno melaminico, laccato antigraffio extra opaco soft-touch, Fenix NTM® e impiallacciato.

EN— Service unit available on castors or fixed with upper glove compartment, push to open door and two drawers. It is available in melamine wood, scratch-resistant soft-touch extra matt lacquered, Fenix NTM® and wood veneer.

F— Meuble de service disponible sur roulettes ou fixe avec plateau supérieur pour objets, porte et deux tiroirs push to open. Il est disponible en bois mélaminé, en laqué extra mat résistant aux rayures soft-touch, en Fenix NTM® et en plaqué bois.

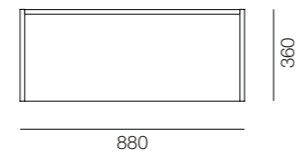
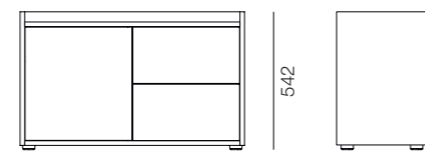
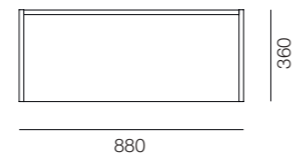
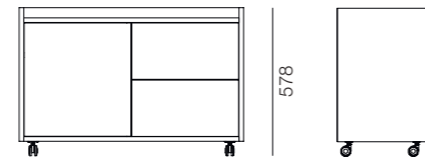

SERVETTO SU RUOTE
SERVICE UNIT ON CASTORS
MEUBLE DE SERVICE SUR ROULETTES

IT— Mobili di servizio su ruote con vani a giorno, tre cassetti e nella versione più ampia con anta push to open e serratura. Sono disponibili in legno melaminico, laccato antigraffio extra opaco soft-touch, Fenix NTM® e impiallacciato.

EN— Service units on castors with open compartments, three drawers and in the larger version with push to open door and lock. They are available in melamine wood, scratch-resistant soft-touch extra matt lacquered, Fenix NTM® and wood veneer.

F— Meubles de service sur roulettes avec des compartiments ouverts, trois tiroirs et, dans la version plus large, avec porte push to open et serrure. Ils sont disponibles en bois de mélamine, en laqué extra mat résistant aux rayures soft-touch, en Fenix NTM® et en plaqué bois.

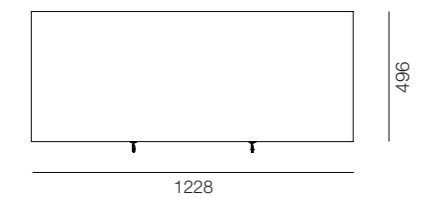
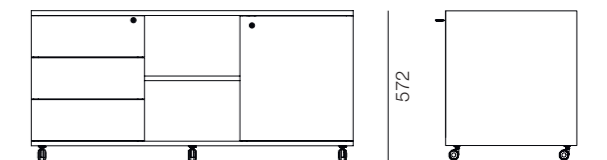
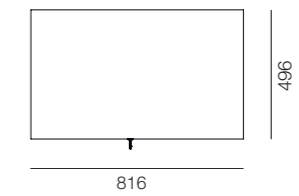
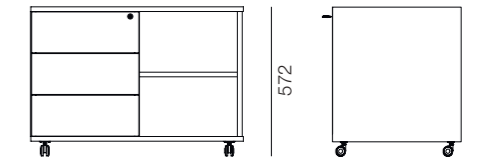

TAVOLO RIUNIONE
MEETING TABLE
TABLE DE RÉUNION

IT— Il tavolo riunione rettangolare, previsto in tre profondità e due lunghezze, ha una struttura con gonnola composta da due gambe disponibili in legno melaminico, laccato antigraffio extra opaco soft-touch, Fenix NTM® e impiallacciato. Il piano può essere in legno melaminico, laccato antigraffio extra opaco soft-touch, Fenix NTM® e impiallacciato con spessore di 27/28/29 mm.

EN— The rectangular meeting table, available in three depths and two lengths, has a structure with modesty panel composed of two legs available in melamine wood, scratch-resistant soft-touch extra matt lacquered, Fenix NTM® and wood veneer. The top can be in melamine wood, scratch-resistant soft-touch extra matt lacquered, Fenix NTM® and wood veneer with a thickness of 27/28/29 mm.

F— La table de réunion rectangulaire, disponible en trois profondeurs et deux longueurs, a une structure avec voile de fond composée de deux pieds disponibles en bois mélaminé, laqué extra mat résistant aux rayures soft-touch, Fenix NTM® et plaqué bois. Le plateau peut être en bois mélaminé, laqué extra mat résistant aux rayures soft-touch, Fenix NTM® et plaqué bois d'une épaisseur de 27/28/29 mm.

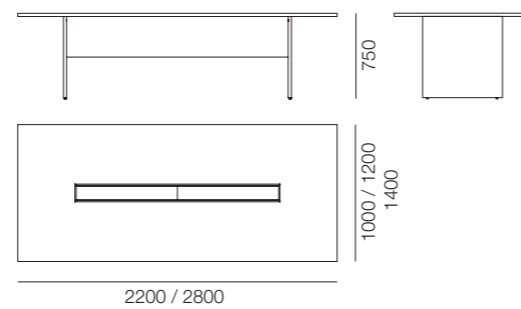

TAVOLO RIUNIONE MODULARE
MODULAR MEETING TABLE
TABLE DE RÉUNION MODULAIRE

IT— Il tavolo riunione modulare è composto da piani componibili in tre profondità e tre lunghezze con gamba centrale condivisa.

EN— The modular meeting table is composed of modular tops in three depths and three lengths with shared central leg.

F— La table de réunion modulaire est composée de plateaux modulaires en trois profondeurs et trois longueurs avec un pied central commun.

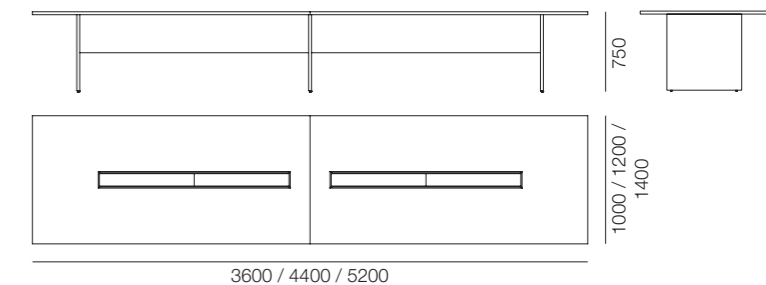
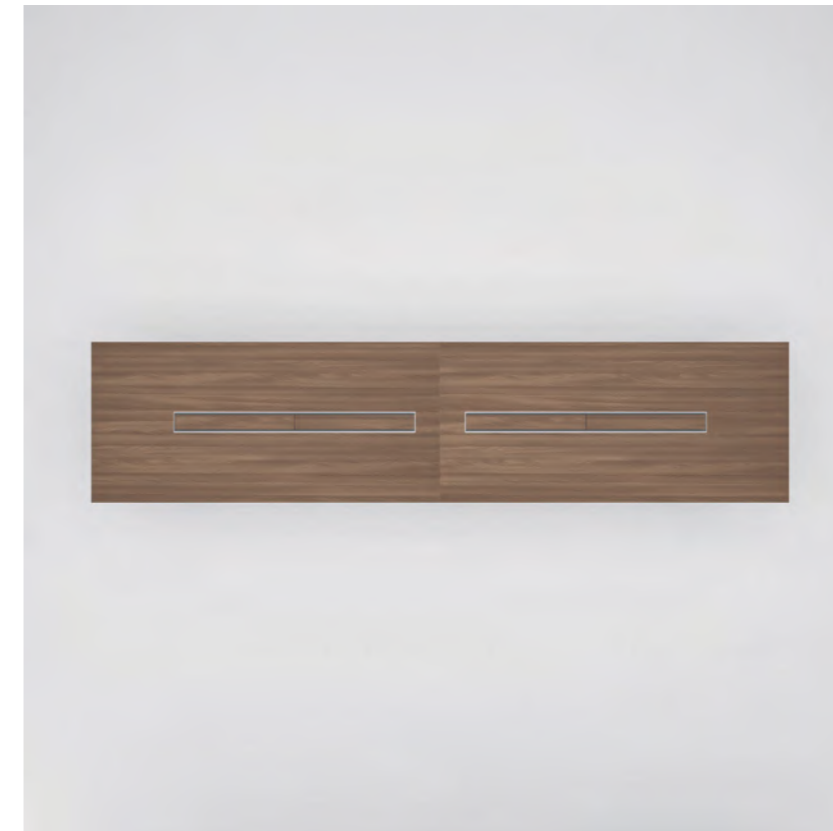

TAVOLO RIUNIONE SAGOMATO
SHAPED MEETING TABLE
TABLE DE RÉUNION EN FORME

IT— Il tavolo riunione sagomato, previsto in tre profondità e due lunghezze, ha una struttura con gonna composta da due gambe disponibili in legno melaminico, laccato antigraffio extra opaco soft-touch, Fenix NTM® e impiallacciato. Il piano può essere in legno melaminico, laccato antigraffio extra opaco soft-touch, Fenix NTM® e impiallacciato con spessore di 27/28/29 mm.

EN— The shaped meeting table, available in three depths and two lengths, has a structure with modesty panel composed of two legs available in melamine wood, scratch-resistant soft-touch extra matt lacquered, Fenix NTM® and wood veneer. The top can be in melamine wood, scratch-resistant soft-touch extra matt lacquered, Fenix NTM® and wood veneer with a thickness of 27/28/29 mm.

F— La table de réunion en forme, disponible en trois profondeurs et deux longueurs, a une structure avec voile de fond composée de deux pieds disponibles en bois mélaminé, laqué extra mat résistant aux rayures soft-touch, Fenix NTM® et plaqué bois. Le plateau peut être en bois mélaminé, laqué extra mat résistant aux rayures soft-touch, Fenix NTM® et plaqué bois d'une épaisseur de 27/28/29 mm.

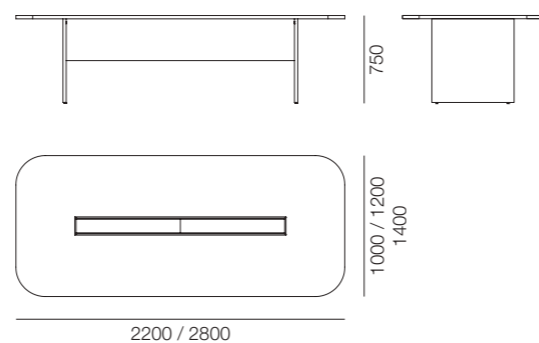

TAVOLO RIUNIONE MODULARE SAGOMATO
SHAPED MODULAR MEETING TABLE
TABLE DE RÉUNION MODULAIRE EN FORME

IT— Il tavolo riunione modulare è composto da piani componibili in tre profondità e tre lunghezze con gamba centrale condivisa.

EN— The modular meeting table is composed of modular tops in three depths and three lengths with shared central leg.

F— La table de réunion modulaire est composée de plateaux modulaires en trois profondeurs et trois longueurs avec un pied central commun.

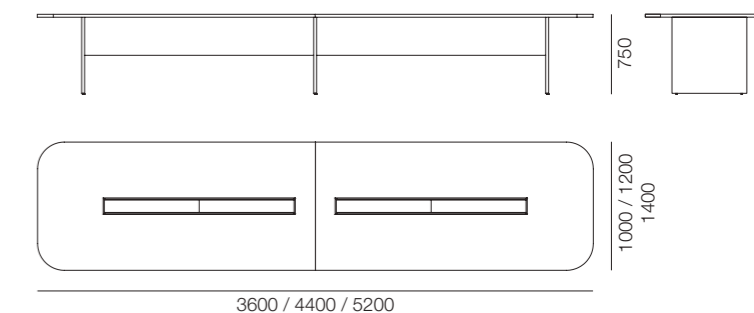

TAVOLI CAFFÈ
COFFEE TABLES
TABLES BASSES

IT— Collezione di tavolini quadrati e rettangolari disponibili in quattro misure, da utilizzare singolarmente o da abbinare tra loro. Hanno struttura e piano sp.18/19 mm disponibili in legno melaminico, laccato antigraffio extra opaco soft-touch, Fenix NTM® e impiallacciato.

EN— Collection of square and rectangular coffee tables available in four sizes, to be used individually or combined with each other. They have structure and top thickness 18/19 mm available in melamine wood, scratch-resistant soft-touch extra matt lacquered, Fenix NTM® and wood veneer.

F— Collection de tables basses carrées et rectangulaires disponibles en quatre tailles, à utiliser individuellement ou à combiner entre elles. Ils ont une structure et un dessus d'épaisseur de 18/19 mm, disponibles en bois mélaminé, en laqué extra mat résistant aux rayures soft-touch, en Fenix NTM® et en plaqué bois.

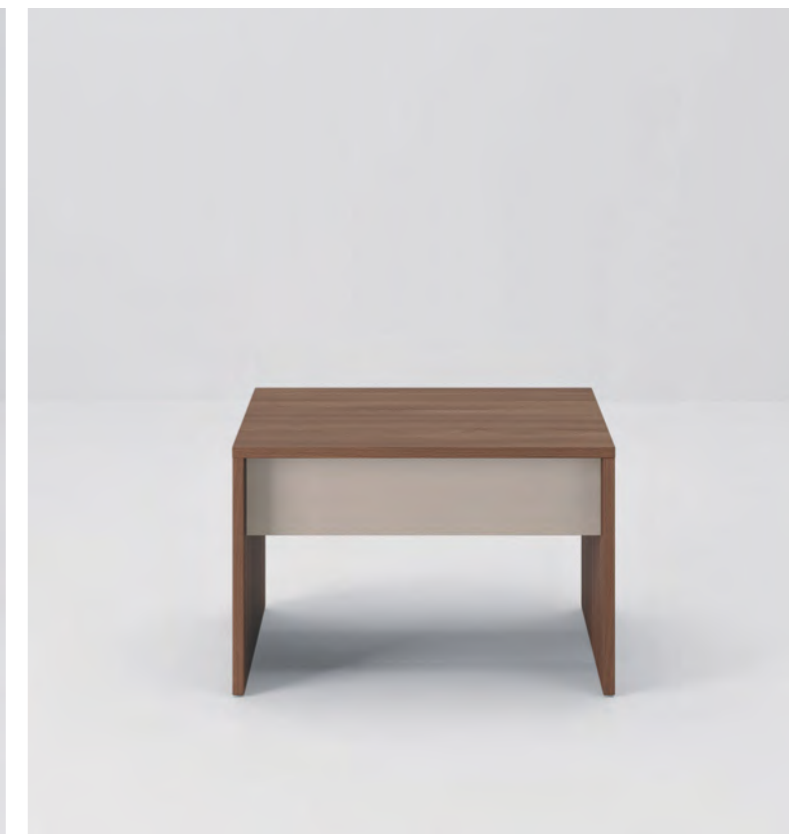
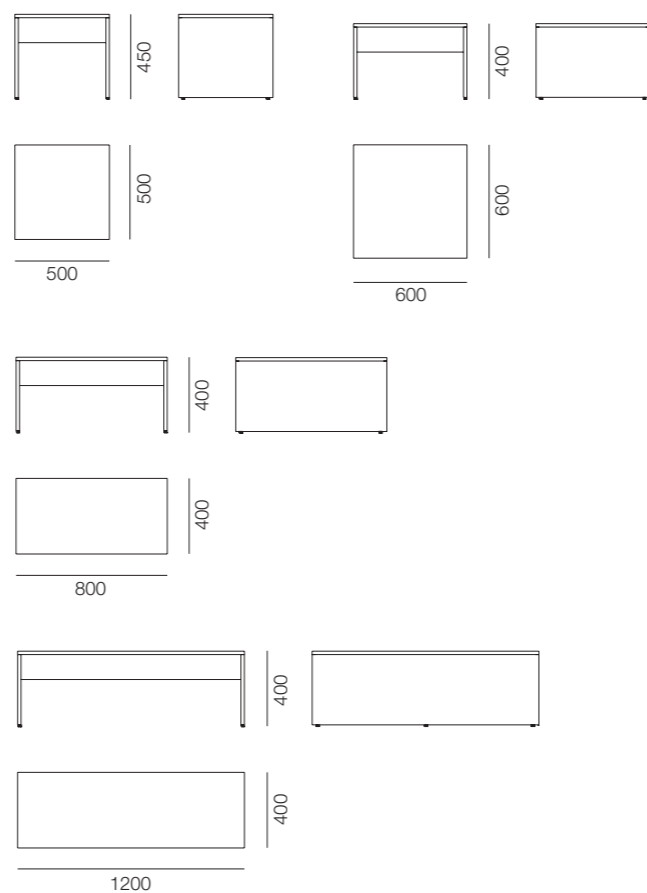

creative & design direction
RMDESIGNSTUDIO / Mariella Vidotti

graphic design & copywriting
RMDESIGNSTUDIO

product design
R&S PROF

photos
concept, set design & styling / RMDESIGNSTUDIO
rendering & styling / SALAPOSA STUDIO

printed in Italy
AGCM / PN
June 2020

L'azienda si riserva in qualunque momento di apportare senza preavviso modifiche a prodotti, accessori e finiture.

The Manufacturer reserves the right to modify products, accessories and finishings at any time without prior notice.

La Société se réserve le droit à tout moment de faire des changements sans préavis aux produits, accessoires et finitions.

Prof srl - Azienda certificata / Certified Company / Entreprise certifiée



PROF

PROF srl
Via Cao de Villa 6/A
Località Falzè di Piave
31020 Senaglia della Battaglia, TV / Italy
T +39 0438 903190 F +39 0438 903228
p.iva / cod.fisc IT03134570260
www.profoffice.it info@profoffice.it

