



**IT**— Dal design essenziale ispirato a linee semplici, Entry è una collezione direzionale di scrivanie e tavoli riunione che risponde alle esigenze di uno spazio di lavoro flessibile, interpretando ambientazioni differenti grazie all'ampia varietà di colori e finiture.

**EN**— With an essential design inspired by simple lines, Entry is a executive collection of desks and meeting tables that meets the needs of a flexible workspace, featuring different settings thanks to the wide variety of colours and finishes.

**F**— Avec un design essentiel inspiré de lignes simples, Entry est une collection directionnelle de bureaux et de tables de réunion qui répond aux besoins d'un espace de travail flexible, interprétant différents décors grâce à la grande variété de couleurs et de finitions.

TAVOLO RIUNIONE  
MEETING TABLE  
TABLE DE RÉUNION

**IT**— Il tavolo riunione rettangolare, previsto in tre profondità e due lunghezze, ha una struttura con gonnola composta da due gambe disponibili in legno melaminico, laccato antigraffio extra opaco soft-touch, Fenix NTM® e impiallacciato. Il piano può essere in legno melaminico, laccato antigraffio extra opaco soft-touch, Fenix NTM® e impiallacciato con spessore di 27/28/29 mm.

**EN**— The rectangular meeting table, available in three depths and two lengths, has a structure with modesty panel composed of two legs available in melamine wood, scratch-resistant soft-touch extra matt lacquered, Fenix NTM® and wood veneer. The top can be in melamine wood, scratch-resistant soft-touch extra matt lacquered, Fenix NTM® and wood veneer with a thickness of 27/28/29 mm.

**F**— La table de réunion rectangulaire, disponible en trois profondeurs et deux longueurs, a une structure avec voile de fond composée de deux pieds disponibles en bois mélaminé, laqué extra mat résistant aux rayures soft-touch, Fenix NTM® et plaqué bois. Le plateau peut être en bois mélaminé, laqué extra mat résistant aux rayures soft-touch, Fenix NTM® et plaqué bois d'une épaisseur de 27/28/29 mm.

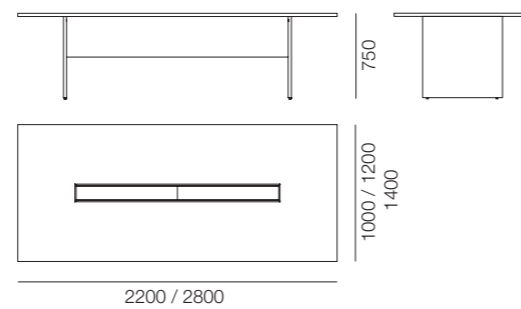

TAVOLO RIUNIONE MODULARE  
MODULAR MEETING TABLE  
TABLE DE RÉUNION MODULAIRE

**IT**— Il tavolo riunione modulare è composto da piani componibili in tre profondità e tre lunghezze con gamba centrale condivisa.

**EN**— The modular meeting table is composed of modular tops in three depths and three lengths with shared central leg.

**F**— La table de réunion modulaire est composée de plateaux modulaires en trois profondeurs et trois longueurs avec un pied central commun.

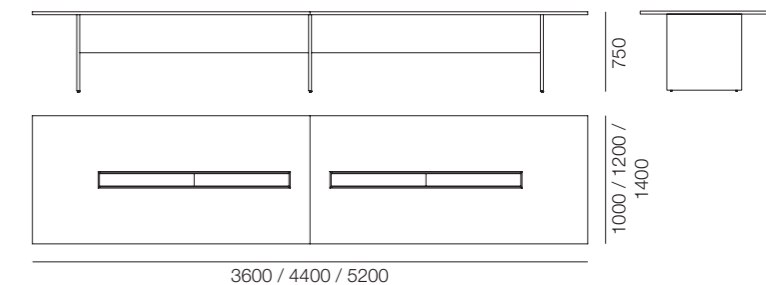



TAVOLO RIUNIONE SAGOMATO  
SHAPED MEETING TABLE  
TABLE DE RÉUNION EN FORME

**IT**— Il tavolo riunione sagomato, previsto in tre profondità e due lunghezze, ha una struttura con gonna composta da due gambe disponibili in legno melaminico, laccato antigraffio extra opaco soft-touch, Fenix NTM® e impiallacciato. Il piano può essere in legno melaminico, laccato antigraffio extra opaco soft-touch, Fenix NTM® e impiallacciato con spessore di 27/28/29 mm.

**EN**— The shaped meeting table, available in three depths and two lengths, has a structure with modesty panel composed of two legs available in melamine wood, scratch-resistant soft-touch extra matt lacquered, Fenix NTM® and wood veneer. The top can be in melamine wood, scratch-resistant soft-touch extra matt lacquered, Fenix NTM® and wood veneer with a thickness of 27/28/29 mm.

**F**— La table de réunion en forme, disponible en trois profondeurs et deux longueurs, a une structure avec voile de fond composée de deux pieds disponibles en bois mélaminé, laqué extra mat résistant aux rayures soft-touch, Fenix NTM® et plaqué bois. Le plateau peut être en bois mélaminé, laqué extra mat résistant aux rayures soft-touch, Fenix NTM® et plaqué bois d'une épaisseur de 27/28/29 mm.

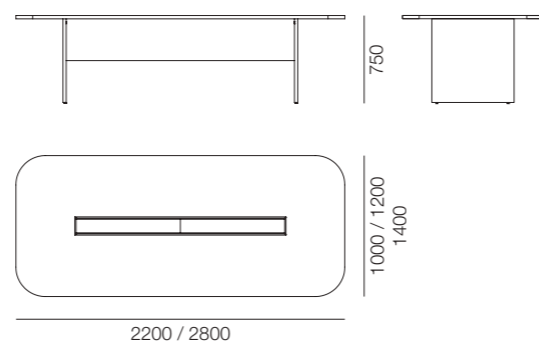

TAVOLO RIUNIONE MODULARE SAGOMATO  
SHAPED MODULAR MEETING TABLE  
TABLE DE RÉUNION MODULAIRE EN FORME

**IT**— Il tavolo riunione modulare è composto da piani componibili in tre profondità e tre lunghezze con gamba centrale condivisa.

**EN**— The modular meeting table is composed of modular tops in three depths and three lengths with shared central leg.

**F**— La table de réunion modulaire est composée de plateaux modulaires en trois profondeurs et trois longueurs avec un pied central commun.

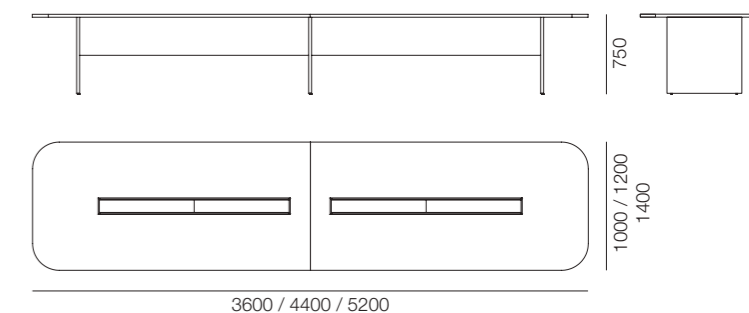

CANALIZZAZIONE TAVOLI RIUNIONE  
MEETING TABLES CABLING SYSTEM  
CANALISATION TABLES DE RÉUNION

**IT**— Il piano può avere un passacavo Proficable rettangolare in finitura anodizzata o verniciato con sportello apribile in tinta con il piano.

**EN**— The top can have a rectangular Proficable cable tidy in anodized or painted finish with an openable door in the same color as the top.

**F**— Le plateau peut comporter un passe-câble Proficable rectangulaire en aluminium anodisé or peint avec une porte ouvrable de la même couleur que le plateau.

FINITURE - FINISHES - FINITIONS

PIANO - TOP - PLATEAU

**ME** - Melaminico - Melamine - Mélamine

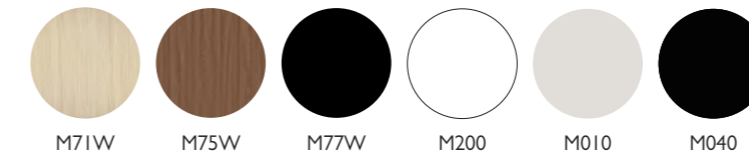

**LA** - Laccato opaco plus - Matt lacquered plus - Laqué mat plus

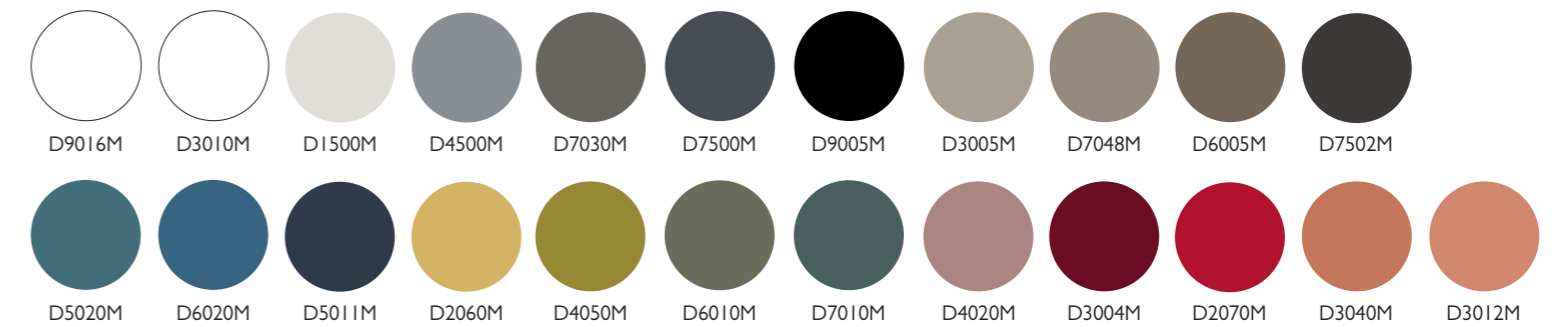

**FX** - Fenix NTM

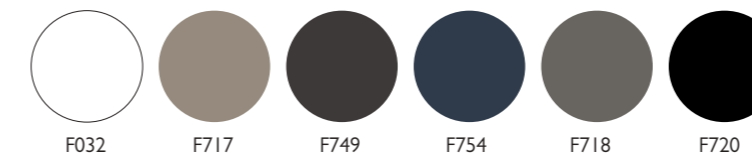

**IM** - Impiallacciato legno - Wood veneer - Plaqué bois

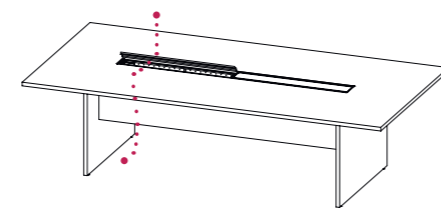
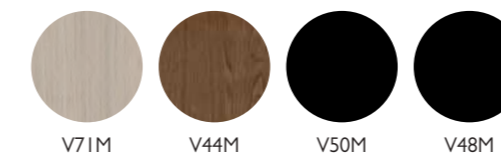

Tavolo riunione rettangolare  
 Rectangular meeeting table  
 Table de réunion rectangulaire

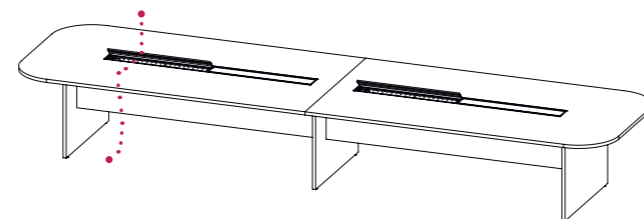

Tavolo riunione sagomato modulare  
 Modular shaped meeeting table  
 Table de réunion en forme modulaire



FINITURE - FINISHES - FINITIONS

GAMBE, GONNA - LEGS, MODESTY PANEL - PIEDS, VOILE DE FOND

---

**ME** - Melaminico - Melamine - Mélamine

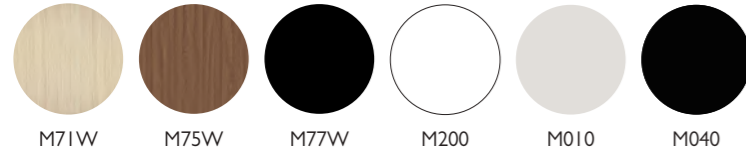

**LA** - Laccato opaco plus - Matt lacquered plus - Laqué mat plus

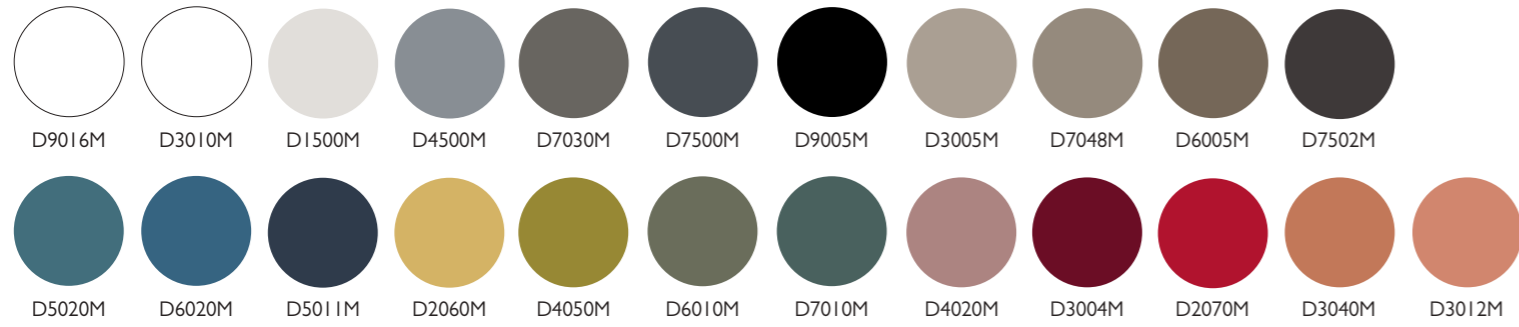

**FX** - Fenix NTM

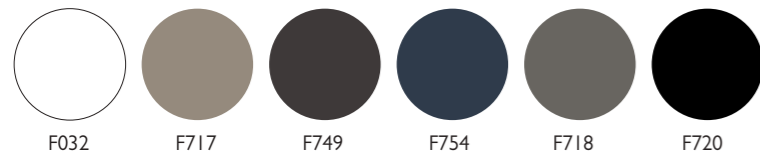

**IM** - Impiallacciato legno - Wood veneer - Plaqué bois

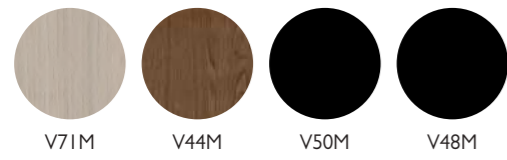

FINITURE - FINISHES - FINITIONS

PASSACAVO - CABLE TIDY - PASSE CÂBLE

---

**MO** - Metallo verniciato opaco - Matt varnished metal - Métal verni mat



**OS** - Alluminio ossidato - oxidized aluminum - Aluminium oxydé

