

EXTRALIGHT

executive collection



PR
OF

EXTRALIGHT

executive collection



**PR
OF**

« CONTENTS »

PAG. 04
CHAPTER 01 - THE COLLECTION

PAG. 18
CHAPTER 02 - THE CATALOGUE

PAG. 22
CHAPTER 03 - BASIC COLORS

PAG. 44
CHAPTER 04 - BRIGHT COLORS

PAG. 64
CHAPTER 05 - MIXED COLORS

PAG. 88
CHAPTER 06 - TECHNICALS





IT— Semplice e versatile, Extralight è una collezione di scrivanie e tavoli riunione caratterizzata da un'essenziale struttura metallica e da un piano leggero, che si inserisce facilmente in ambienti di lavoro diversi. Ricca è la proposta di materiali e finiture, con tonalità coordinate su tutte le superfici. È infatti possibile scegliere una tinta unica per piano e struttura o un mix di colori in perfetto accostamento cromatico. Il piano può essere in legno melaminico, vetro laccato anti touch, brillante ed effetto marmo, Fenix NTM® e legno impiallacciato. La struttura è verniciata opaca in tutta la gamma di colori a catalogo. La scrivania viene proposta con o senza gonna in versione semplice, con piano dattilo, su modular unit e su sliding unit. I tavoli riunione rettangolari sono previsti in varie profondità e possono essere composti in configurazioni con gamba centrale condivisa per la canalizzazione. In più dimensioni, sono disponibili tavoli riunione rotondi con base cilindrica metallica. La collezione si integra perfettamente con gli altri sistemi di arredo Prof, come i contenitori Profbox e Profslide, le librerie Profcase, i tavoli Table, le lampade Grace e tutti i complementi Profmood per creare ambienti di lavoro completi e personalizzati.

« THE COLLECTION »

EN— Simple and versatile, Extralight is a collection of desks and meeting tables characterized by an essential metal structure and a light top, which fits easily into different work environments. Rich is the proposal of materials and finishes, with coordinated shades on all surfaces. It is infact possible to choose one color for the top and the structure or a mix of colors in perfect color combination. The top can be in melamine wood, anti touch lacquered glass, brilliant and marble effect, Fenix NTM® and veneered wood. The structure is matt painted in the entire range of colors in the catalogue. The desk is offered with or without a modesty panel in a simple version, with an extension, on a modular unit and on a sliding unit. Rectangular meeting tables are available in various depths and can be composed in configurations with a shared central leg for channeling. In several sizes, round meeting tables with cylindrical metal base are available. The collection integrates perfectly with other Prof furnishing systems, such as Profbox and Profslide cabinets, Profcase bookcases, Table tables, Grace lamps and all Profmood complements, to create complete and personalized work environments.

F— Simple et polyvalent, Extralight est une collection de bureaux et de tables de réunion caractérisée par une structure métallique essentielle et un plateau léger, qui s'intègre facilement dans différents environnements de travail. Rich est la proposition des matériaux et des finitions assortis de nuances coordonnées sur toutes les surfaces. Il est en effet possible de choisir une seule couleur pour le dessus et la structure ou un mélange de couleurs dans une combinaison de couleurs parfaite. Le plateau peut être en bois mélaminé, verre laqué anti empreintes, effet brillant et effet marbre, Fenix NTM® et bois plaqué. La structure est peinte mate dans toute la gamme de couleurs du catalogue. Le bureau est proposé avec ou sans voile de fond dans une version simple, avec une extension, sur un modular unit et sur un sliding unit. Les tables de réunion rectangulaires sont disponibles dans différentes profondeurs et peuvent être composées dans des configurations avec un pied central partagé pour la canalisation. Dans plusieurs tailles, des tables de réunion rondes avec base en métal cylindrique sont disponibles. La collection s'intègre parfaitement à d'autres systèmes d'ameublement Prof, tels que les armoires Profbox et Profslide, les bibliothèques Profcase, les tables Table, les lampes Grace et tous les compléments Profmood, pour créer des environnements de travail complets et personnalisés.

PETROLIO
PETROLEUM
PÉTROLE

piano / top / plateau

VA 5020
vetro laccato anti touch
anti touch lacquered glass
verre laqué anti empreintes

struttura / structure / structure

MO2 5020
metallo verniciato opaco
matt varnished metal
métal verni mat

gonna / modesty panel / voile de fond

VA 5020
vetro laccato anti touch
anti touch lacquered glass
verre laqué anti empreintes

GRIGIO PERLA
PEARL GREY
GRIS PERLE

piano / top / plateau

VA 7045
vetro laccato anti touch
anti touch lacquered glass
verre laqué anti empreintes

struttura / structure / structure

MO2 7045
metallo verniciato opaco
matt varnished metal
métal verni mat

gonna / modesty panel / voile de fond

VA 7045
vetro laccato anti touch
anti touch lacquered glass
verre laqué anti empreintes

BLU SCURO
DARK BLUE
BLEU FONCÉ

piano / top / plateau

FX 0754
Fenix NTM®
Fenix NTM®
Fenix NTM®

struttura / structure / structure

MO2 5011
metallo verniciato
matt varnished metal
métal verni mat

gonna / modesty panel / voile de fond

FX 0754
Fenix NTM®
Fenix NTM®
Fenix NTM®

ONE COLOR ONLY

IT— Nell'ampia palette dei colori e delle finiture si può abbinare un'unica tonalità a tutti gli elementi e le superfici della scrivania per un mood tono su tono.

EN— In the wide palette of colors and finishes it is possible to combine a single shade with all the elements and surfaces of the desk for a tone on tone mood.

F— Dans la large palette de couleurs et de finitions, il est possible de combiner une seule teinte avec tous les éléments et surfaces du bureau pour créer une ambiance ton sur ton.



ROSSO ORIENTE + RAME
ORIENT RED + COPPER
ROUGE ORIENT + CUIVRE

piano / top / plateau

MC 29
 colore melaminico
 melamine colour
 couleur mélaminé

struttura / structure / structure

MO2 3012
 metallo verniciato opaco
 matt varnished metal
 métal verni mat

gonna / modesty panel / voile de fond

MC 29
 colore melaminico
 melamine colour
 couleur mélaminé

NOCE DARK + ROSSO RUBINO
DARK WALNUT + RUBY RED
NOYER FONCÉ + ROUGE RUBIS

piano / top / plateau

ME 77
 melaminico
 melamine
 mélaminé

struttura / structure / structure

MO2 3004
 metallo verniciato opaco
 matt varnished metal
 métal verni mat

gonna / modesty panel / voile de fond

ME 77
 melaminico
 melamine
 mélaminé

TABACCO + NERO
TOBACCO + BLACK
TABAC + NOIR

piano / top / plateau

MC 25
 colore melaminico
 melamine colour
 couleur mélaminé

struttura / structure / structure

MO1 9005
 metallo verniciato opaco
 matt varnished metal
 métal verni mat

gonna / modesty panel / voile de fond

MC 25
 colore melaminico
 melamine colour
 couleur mélaminé

MIX OF COLORS

IT— I materiali e i colori del piano possono essere combinati facilmente a tutte le tonalità opache della struttura metallica per creare abbinamenti a contrasto.

EN— The materials and colors of the top can be easily combined with all the opaque shades of the metal structure to create contrasting combinations.

F— Les matériaux et les couleurs du plateau peuvent facilement être combinés avec toutes les nuances opaques de la structure en métal pour créer des combinaisons contrastées.



DESK

IT— La scrivania è prevista in quattro lunghezze 1840/2040/2240/2440 mm e due profondità 800/1000 mm ed è disponibile anche con gonna. Su richiesta si può avere un passacavo metallico Proficable con sportello in tinta con il piano.

EN— The desk is available in four lengths 1840/2040/2240/2440 mm and two depths 800/1000 mm and is also available with a modesty panel. On request we can have a Proficable metal cable tidy with flap top matching the desk top.

F— Le bureau est disponible en quatre longueurs: 1840/2040/2240/2440 mm et deux profondeurs 800/1000 mm. Il est également disponible avec une voile de fond. Sur demande, nous pouvons avoir un passe-cable en métal Proficable avec un top le meme couleur que le plateau.

**DESK + EXTENSION**

IT— Con una gamba speciale dedicata, la scrivania viene proposta in versione con dattilo, che funge da comoda estensione del piano, a cui si può aggiungere una cassetiera su ruote nelle finiture abbinata.

EN— With a special dedicated leg, the desk is offered in an extension version, which acts as a convenient extension of the top, to which can be added a pedestal drawer on wheels in matching finishes.

F— Avec un pied spécial, le bureau est proposé dans une version avec extension, qui constitue une extension pratique du plateau, auquel peut être ajoutée une caisson tiroirs à roulettes aux finitions assorties.



DESK + MODULAR UNIT

IT— Per una maggiore archiviazione, è disponibile la scrivania su modular unit. Grazie alla modularità di quest'ultimo e alla vasta selezione dei colori coordinati, permette di organizzare la scrivania secondo le proprie esigenze di lavoro. Si può scegliere tra moduli di larghezze e funzioni diverse, dai cassetti, ai classificatori, ai vani chiusi, a giorno e porta cpu. Su richiesta si può attrezzare per il passaggio cavi di elettrificazione.



EN— For greater storage, the desk is also available in a version with modular unit. Thanks to the modularity of this one and the wide selection of coordinated colors, it allows you to organize the desk according to your work needs. You can choose between modules of different widths and functions, from drawers, to filing drawers, to closed compartments, open compartments and cpu holders. On request it can be equipped for the passage of electrification cables.

F— Pour un stockage plus important, le bureau est également disponible dans une version intégrée dans un modular unit. Grâce à la modularité de ceci et au large choix de couleurs coordonnées, il vous permet d'organiser le bureau en fonction de vos besoins. Vous pouvez choisir entre des modules de différentes largeurs et fonctions, des tiroirs aux tiroirs, en passant par les compartiments fermés, les compartiments ouverts et les supports de processeurs. Sur demande, il peut être équipé pour le passage de câbles d'électrification.



MEETING TABLE

IT— I tavoli riunione rettangolari sono proposti in tre profondità 1000/1230/1630 mm e varie lunghezze da 1040 fino a 2440 mm. Possono essere canalizzati con passacavo Profcable con sportello in finitura con il piano.

EN— The rectangular meeting tables are offered in three depths 1000/1230/1630 mm and various lengths from 1040 up to 2440 mm. They can be ducted with a Profcable cable tidy with flap top the same finish with the desk top.

F— Les tables de réunion rectangulaires sont proposées dans trois profondeurs 1000/1230/1630 mm et dans différentes longueurs de 1040 à 2440 mm. Ils peuvent être canalisés avec un passe-cable Profcable avec un top en finition avec le plateau.

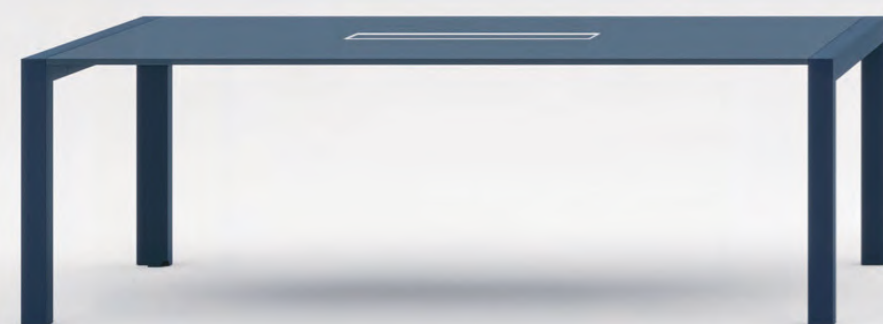
**MODULAR MEETING TABLE**

IT— In profondità 1230 e 1630 mm possono essere composti in varie configurazioni modulari, con gamba centrale condivisa per la canalizzazione verticale.

EN— In depth 1230 and 1630 mm, they can be composed in various modular configurations, with shared central leg for vertical channeling.

F— En profondeur, 1230 et 1630 mm peuvent être composés selon différentes configurations modulaires, avec pied central partagé pour canalisation verticale.

MEETING TABLE

IT— Tavolo riunione rotondo con base cilindrica in metallo previsto in tre misure. Ha un piano con bordo a saponetta disponibile in legno o in vetro. È caratterizzato da un inserto centrale che può avere una torretta sollevabile elettricamente.

EN— Round meeting table with cylindrical metal base available in three sizes. It has a top with rounded edges available in wood or glass. It is characterized by a central insert that can have an electrically raised turret.

F— Table de réunion ronde avec base métallique cylindrique disponible en trois tailles. Il a un dessus avec des bords arrondis disponibles en bois ou en verre. Il se caractérise par un insert central pouvant comporter une tourelle surélevée.

**MEETING TABLE**

IT— Tavolo riunione diametro 1600 mm rotondo con base cilindrica in metallo. Ha un piano con bordo a saponetta disponibile in legno o in vetro, fornito di serie con passacavo rotondo.

EN— Round meeting table 1600 mm diameter with cylindrical metal base. It has a top with waterfall edges available in wood or glass, with production round cable tidy.

F— Table de réunion ronde 1600 mm diam. avec base métallique cylindrique. Il a un dessus avec des bords arrondis disponibles en bois ou en verre, livré avec passe câble rond.





IT— La versatilità della collezione Extralight è data anche dalla rinnovata gamma di colori e finiture, che rispondono alle esigenze individuali di personalizzare lo spazio di lavoro. I nove abbinamenti cromatici proposti in questo catalogo comprendono scrivanie e tavoli riunioni in perfetta armonia con tutti gli altri prodotti delle collezioni Prof. In versione monocromatica, i tre colori base (basic): bianco, nero e grigio perla che esprimono eleganza e rigore, da sempre protagonisti indiscussi negli arredi per ufficio. A seguire tre colori vivaci (bright): curry, petrolio e verde oliva che trasmettono vitalità e ben interpretano il dinamismo dell'ambiente di lavoro contemporaneo. Per finire tre mix di colori (mixed): rosso oriente e rame, vetro stone grey e bianco, legno noce natural e basalto per incontrare esigenze e gusti diversi.

« THE CATALOGUE »

EN— The versatility of the Extralight collection is also given by the renewed range of colors and finishes, which respond to individual needs to personalize the work space. The nine color combinations proposed in this catalogue include desks and meeting tables in perfect harmony with all the other products in Prof collections. In monochromatic version, the three basic colors (basic): white, black and pearl grey that express elegance and rigor, always undisputed protagonists in office furniture. This is followed by three bright colors (bright): curry, petroleum and orient red that transmit vitality and well interpret the dynamism of the contemporary work environment. To finish, three mixed colors (mixed): olive green in a single color version, stone grey and white glass, natural walnut and basalt wood to meet different needs and tastes.

F— La polyvalence de la collection Extralight provient également de la nouvelle gamme de couleurs et de finitions, qui répondent aux besoins individuels pour personnaliser l'espace de travail. Les neuf combinaisons de couleurs proposées dans ce catalogue comprennent des bureaux et des tables de réunion en parfaite harmonie avec tous les autres produits des collections Prof. En version monocromatique, les trois couleurs de base (basic): blanc, noir et gris perle qui expriment élégance et rigueur, protagonistes toujours incontestés du mobilier de bureau. Viennent ensuite trois couleurs vives (bright): le curry, le pétrole et le rouge orient qui transmettent la vitalité et interprètent bien le dynamisme du milieu de travail contemporain. Pour finir, trois mélanges de couleurs (mixed): vert olive dans une version unicolore, verre stone grey et blanc, noyer naturel et basalte pour répondre aux différents besoins et goûts.

BASIC COLORS



BIANCO
WHITE
BLANC

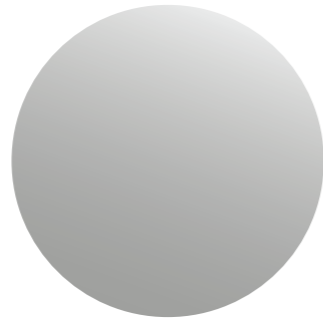

GRIGIO PERLA
PEARL GREY
GRIS PERLE

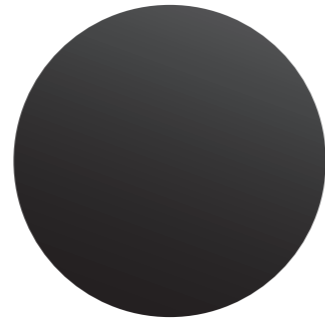

NERO
BLACK
NOIR

BRIGHT COLORS

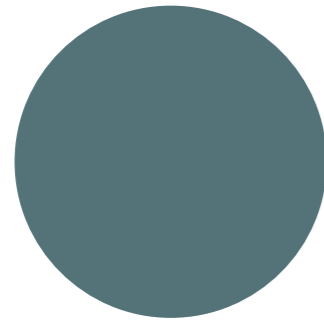

PETROLIO
PETROLEUM
PÉTROLE

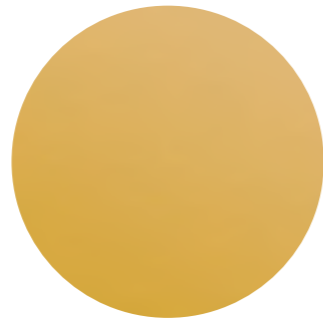

CURRY
CURRY
CURRY

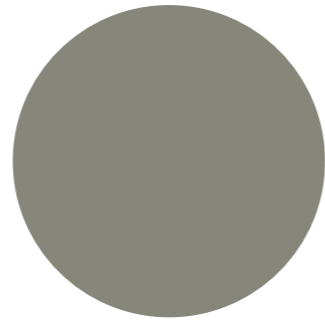

VERDE OLIVA
OLIVE GREEN
VERT OLIVE

MIXED COLORS

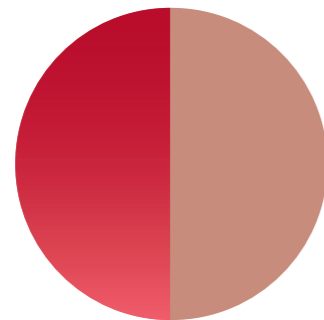

ROSSO ORIENTE / RAME
ORIENT RED / COPPER
ROUGE ORIENT / CUIR



NOCE NATURALE / BASALTO
NATURAL WALNUT / BASALT
NOYER NATURELLE / BASALTE

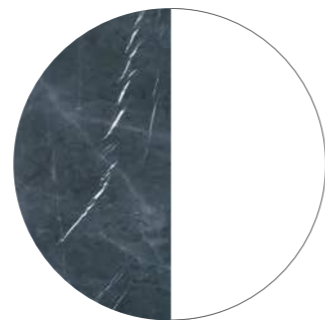

STONE GREY / BIANCO
STONE GREY / WHITE
STONE GREY / BLANC



BASIC
COLOR
01



BASIC
COLOR
02



BASIC
COLOR
03



BRIGHT
COLOR
01



BRIGHT
COLOR
02



BRIGHT
COLOR
03



MIXED
COLOR
01



MIXED
COLOR
02



MIXED
COLOR
03

**piano / top / plateau**

VA 9010
 vetro laccato anti touch bianco
 white anti touch lacquered glass
 verre laqué anti empreintes blanc

struttura / structure / structure

MO1 9010
 metallo verniciato opaco bianco
 white matt varnished metal
 métal verni mat blanc

gonna / modesty panel / voile de fond

ME 20
 melaminico bianco
 white melamine
 mélaminé blanc

« BASIC COLORS »

01

IT— La scrivania è proposta con piano in vetro anti touch bianco e gonna melaminico bianco. Nella foto successiva particolare del carter verticale agganciato alla struttura della scrivania per la canalizzazione verticale. Il contenitore Profbox ha ante in vetro bianco anti touch con profilo e maniglie metalliche tutte in tinta. Il tavolo riunioni ha un piano in vetro bianco anti touch ed è dotato di un passacavo Profcable verniciato bianco e sportello apribile in vetro abbinato.

EN— The desk is proposed with white anti touch glass top and white melamine modesty panel. In the following photo, detail of the vertical carter attached to the desk structure for vertical cabling. The Profbox cabinet has white anti touch glass doors with metal profile and handles all in matching color. The meeting table has a white anti touch glass top and it is equipped with a white painted Profcable cable tidy and an openable flap top with the same glass.

F— Le bureau est proposé avec le dessus en verre blanc anti empreintes et voile de fond en mélamine blanche. Sur la photo suivante, détail du carter vertical fixé à la structure du bureau pour canalisation verticale. Le conteneur Profbox a des portes en verre anti empreintes blanches avec un profil en métal et des poignées de couleurs assorties. La table de réunion a un plateau en verre anti empreintes blanc et est équipée d'un passe-câble Profcable peint en blanc et d'un top en verre pouvant être ouverte.



DESK — 2240 x 1000 x H 740 mm



BASIC COLORS 01



PROFBOX — 1836 x 470 x H 868 mm





MEETING TABLE — 2440 x 1230 x H 740 mm



**piano / top / plateau**

VA 7045

vetro laccato anti touch grigio perla
 pearl grey anti touch lacquered glass
 verre laqué anti empreintes gris perle

struttura / structure / structure

MO2 7045

metallo verniciato opaco grigio perla
 pearl grey matt varnished metal
 métal verni mat gris perle

gonna / modesty panel / voile de fond

VA 7045

vetro laccato anti touch grigio perla
 pearl grey anti touch lacquered glass
 verre laqué anti empreintes gris perle

« BASIC COLORS »

02

IT— La scrivania è presentata con piano dattilo e cassettera su ruote tutto in tonalità grigio perla. Il piano e la gonna sono in vetro anti touch, la cassettera in legno melaminico. I contenitori Profbox abbinati nelle due altezze hanno ante in vetro anti touch grigio perla con profilo e maniglie metalliche dello stesso colore. Il tavolo riunione rotondo con inserto centrale ha il piano in vetro anti touch grigio perla con base metallica in tinta.

EN— The desk is presented with an extension table and drawer unit on wheels all in pearl grey tones. The top and the modesty panel are in anti touch glass, the pedestal drawers in melamine wood. The Profbox cabinets combined in the two heights have pearl grey anti touch glass doors with metal profiles and handles of the same color. The round meeting table with central insert has a pearl grey anti touch glass top with a matching metal base.

F— Le bureau est présenté avec une extension et une caisson tiroir sur roulettes, tous dans des tons gris perle. Le plateau et le voile de fond sont en verre antiempreintes, le caisson tiroirs en bois mélaminé. Les armoires Profbox combinés dans les deux hauteurs ont des portes en verre anti empreintes gris perle avec des profils en métal et des poignées de la même couleur. La table de réunion ronde avec insert central a un plateau en verre anti empreintes gris perle et une base en métal assortie.

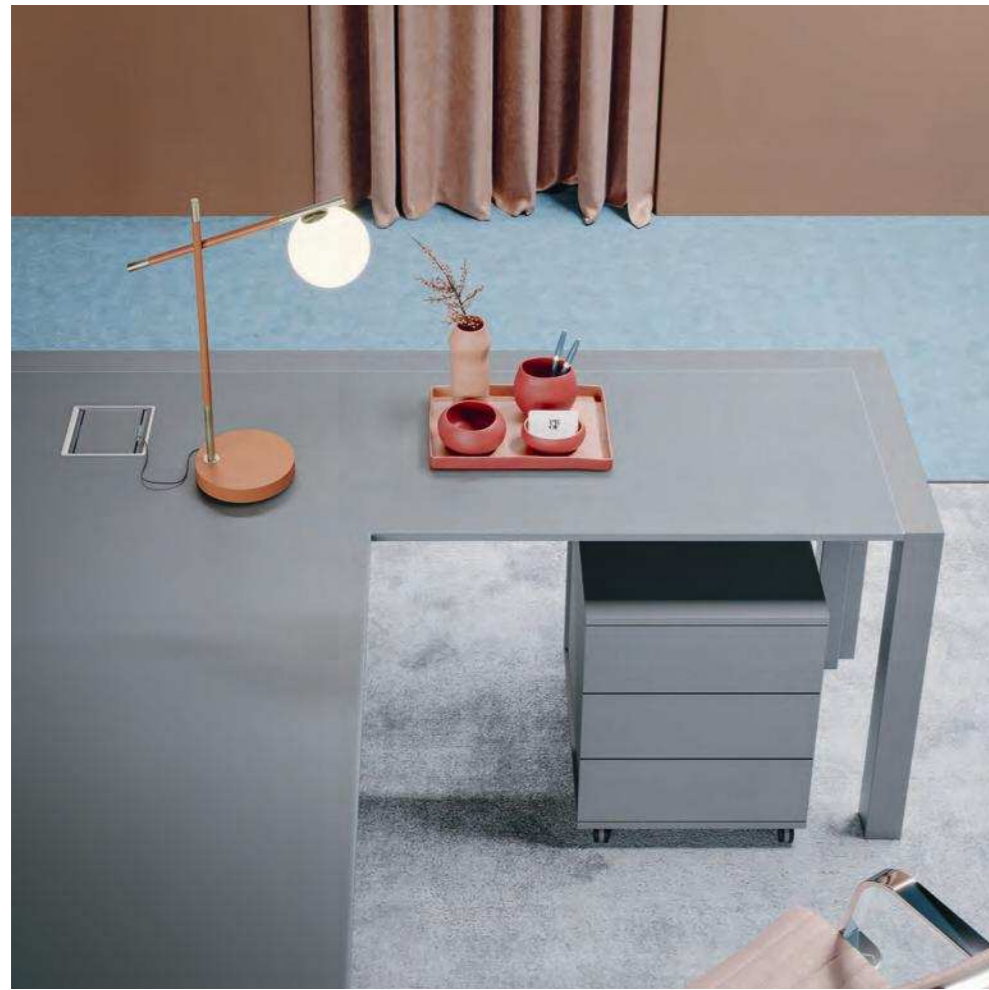

DESK — 2240 x 2000 x H 740 mm



BASIC COLORS 02



MEETING TABLE— Ø 1800 x H 740 mm



PROFBOX— 1838 x 470 x H 1284 mm



PROFBOX— 1838 x 470 x H 2117 mm



piano / top / plateau
FX 0720
nero Fenix NTM®
black Fenix NTM®
noir Fenix NTM®

struttura / structure / structure
MO1 9005
metallo verniciato opaco nero
black matt varnished metal
métal verni mat noir

gonna / modesty panel / voile de fond
FX 0720
nero Fenix NTM®
black Fenix NTM®
noir Fenix NTM®

« BASIC COLORS »

03

IT— La scrivania è proposta con dattilo e cassetiera su ruote in un unico colore nero Fenix NTM®. Nella stessa tonalità, i contenitori Profbox con color unit in tinta e il tavolo riunione modulare con gamba centrale e passacavo Profcable su piano per l'elettificazione.

EN— The desk is proposed with extension and drawer unit on wheels in a single black Fenix NTM® color. In the same shade, the Profbox cabinets with matching color unit and the modular meeting table with a central leg and the Profcable cable tidy on top for electrification.

F— Le bureau est proposé avec une extension et un caisson tiroirs sur roulettes en une seule couleur noir Fenix NTM®. Dans la même teinte, les armoires Profbox avec le color unit et le table de réunion modulaire avec une jambe centrale et un passe-câble Profcable sur un plateau pour l'électrification.



DESK — 2240 x 2000 x H 740 mm



MEETING TABLE — 3940 x 1230 x H 740 mm

**piano / top / plateau**

VA 5020
 vetro laccato anti
 touch petrolio
 petroleum anti touch
 lacquered glass
 verre laqué anti empre-
 intes pétrole

struttura / structure / structure

MO2 5020
 metallo verniciato opaco petrolio
 petroleum matt varnished metal
 métal verni mat pétrole

gonna / modesty panel / voile de fond

VA 5020
 vetro laccato anti touch petrolio
 petroleum anti touch lacquered glass
 verre laqué anti empreintes pétrole

« BRIGHT COLORS »

01

IT— Scrivania con dattilo tutta giocata tono su tono nel colore petrolio con piano e gonna in vetro anti touch e cassettera su ruote in legno melaminico. In accostamento, contenitore Profbox con ante push to open di diversa larghezza. Nelle pagine seguenti, tavoli alti per aree break e meeting informali con piani in vetro anti touch petrolio e struttura abbinata in tinta.

EN— Desk with extension all in tone on tone in petroleum color with anti touch glass top and modesty panel and pedestal drawer in melamine wood on wheels. In combination, Profbox cabinet with push to open doors of different widths. On the following pages, high tables for break areas and informal meetings with an anti touch petroleum glass tops and matching structure.

F— Bureau avec extension tout en ton sur ton dans la couleur pétrole avec le plateau et le voile de fond en verre laqué anti empreintes , et le caisson tiroirs sur des roues en bois mélaminé. En combinaison, l'armoire Profbox avec portes push pour ouvrir de différentes largeurs. Sur les pages suivantes, tables hautes pour les espaces de pause et réunions informelles avec plateaux en verre anti empreintes pétrole et structure assortie.



DESK — 2240 x 2000 x H 740 mm



PROFMOOD COMPLEMENTS — SHADE + JACKIE



PROFBOX — 1838 x 470 x H 1284 mm

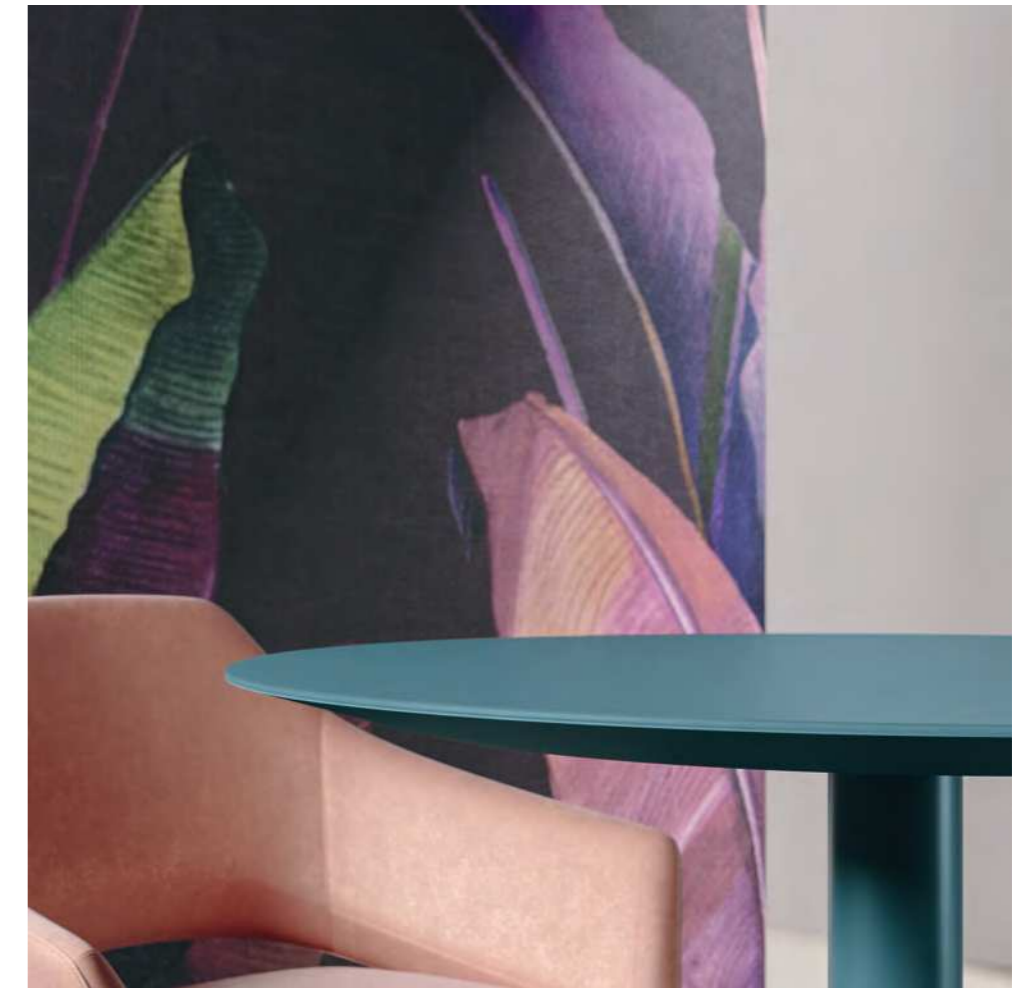

MEETING TABLE — Ø 800 x H 1050 mm

**piano / top / plateau**

VA 1032
 vetro laccato anti touch curry
 curry anti touch lacquered glass
 verre laqué anti empreintes curry

struttura / structure / structure

MO2 1032
 metallo verniciato opaco curry
 curry matt varnished metal
 métal verni mat curry

modular unit

MC 32
 melaminico curry
 curry melamine
 mélaminé curry

« BRIGHT COLORS »

02

IT— Nella tonalità curry, la scrivania con piano in vetro anti touch è abbinata al mobile modular unit canalizzato, che può avere numerose configurazioni per organizzare a piacere lo spazio di lavoro. A completamento, mobile Profbox in legno melaminico curry con ante push to open e moduli color unit. Nelle pagine seguenti, area attesa con tavoli caffè rotondi in diverse misure con piano in vetro anti touch grigio perla e curry.

EN— In the curry tone, the desk with an anti touch glass top is combined with the channeled modular unit, which can have numerous configurations to organize the work space as desired. To complete, Profbox cabinet in curry melamine with push to open doors and color unit modules. In the following pages, waiting area with round coffee tables in different sizes with anti touch glass top pearl grey and curry.

F— Dans le ton du curry, le bureau avec plateau en verre anti touch est combiné au meuble modular unit canalisé, qui peut avoir de nombreuses configurations pour organiser l'espace de travail à votre guise. Pour compléter, armoire Profbox en mélamine curry avec portes à ouverture push pour ouvrir et modules color unit. Dans les pages suivantes, salle d'attente avec tables basses rondes de différentes tailles, plateau en verre anti empreintes gris perle et curry.

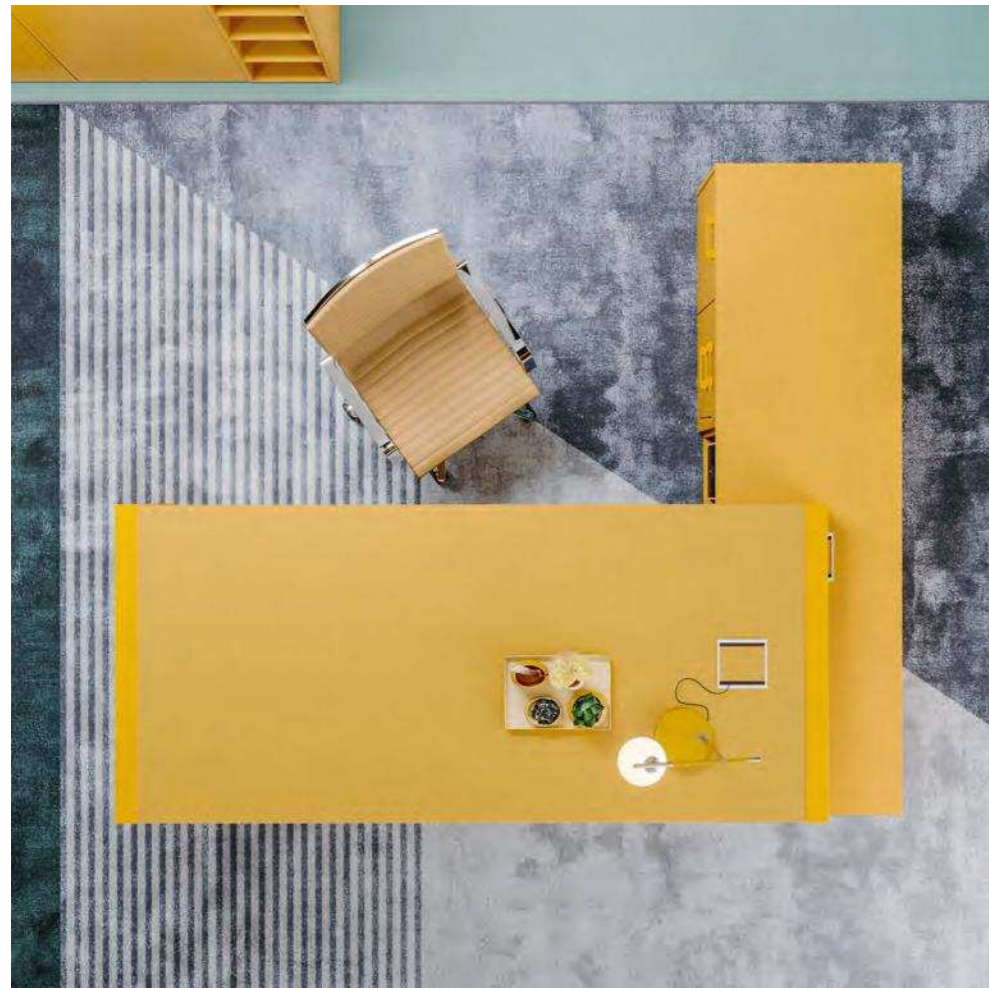

DESK — 2505 x 2100 x H 740 mm





PROFBOX — 1838 x 470 x H 1284 mm



COFFEE TABLES — Ø 800 x H 400 mm / Ø 500 x H 500 mm



piano / top / plateau
MC 24
melaminico verde oliva
olive green melamine
mélaminé vert olive

struttura / structure / structure
MO2 7003
metallo verniciato opaco verde oliva
olive green matt varnished metal
métal verni mat vert olive

gonna / modesty panel / voile de fond
MC 24
melaminico verde oliva
olive green melamine
mélaminé vert olive

modular unit
MC 24
melaminico verde oliva
olive green melamine
mélaminé vert olive

« BRIGHT COLORS »

03

IT— Tutta in legno melaminico verde oliva, la scrivania è integrata al mobile modular unit attrezzato con ante, cassetti e vani a giorno. In accostamento, il contenitore Profbox in legno melaminico blu sea con vano color unit verde oliva.

EN— All in olive green melamine wood, the desk is integrated into the modular unit equipped with doors, drawers and open compartments. In combination, the Profbox container in blue sea melamine with an olive green color unit compartment.

F— Tout en bois de mélamine vert olive, le bureau est intégré à l'unité de mobile modular unit équipée de portes, tiroirs et compartiments ouverts. En combinaison, le conteneur Profbox en mélaminé mer bleue avec un compartiment d'unité de couleur vert olive.



PROFBOX — 1836 x 470 x H 1284 mm



DESK — 2505 x 2100 x H 740 mm



**piano / top / plateau**

VA 3031
 vetro laccato anti touch rosso oriente
 orient red anti touch lacquered glass
 verre laqué anti empreintes rouge orient

struttura / structure / structure

MO2 3012
 metallo verniciato opaco rame
 copper matt varnished metal
 métal verni mat cuivre

gonna / modesty panel / voile de fond

VA 3031
 vetro laccato anti touch rosso oriente
 orient red anti touch lacquered glass
 verre laqué anti empreintes rouge orient

« MIXED COLORS »

01

IT— La scrivania è proposta in due tonalità con piano e gonna in vetro anti touch rosso oriente in accostamento alla struttura verniciata color rame. Negli stessi abbinamenti di colore il contenitore Profbox con ante in legno melaminico rosso oriente e maniglie a contrasto. A seguire, tavolo riunione rotondo rosso oriente con piano in vetro anti touch e base metallica.

EN— The desk is available in two shades with an anti touch orient red glass top and modesty panel that matches the copper-colored painted structure. In the same combinations of colors, the Profbox container with melamine orient red doors and contrasting handles. Following, round orient red meeting table with anti touch glass top and metal base.

F— Le bureau est disponible dans deux teintes avec un plateau et une voile de fond en verre anti empreintes rouge orient qui correspond à la structure peinte de couleur cuivre. Dans les mêmes combinaisons, le conteneur Profbox avec portes en mélaminé rouge orient et poignées contrastantes. Ensuite, une table de réunion ronde rouge orient avec un plateau en verre anti empreintes et une base en métal.



DESK — 2240 x 1000 x H 740 mm





PROFBOX — 1836 x 470 x H 1284 mm



MEETING TABLE — Ø 1200 x H 740 mm



piano / top / plateau
ME 75
melaminico noce natural
natural walnut melamine
mélaminé noyer naturelle

struttura / structure / structure
MO2 7011
metallo verniciato opaco basalto
basalt matt varnished metal
métal verni mat basalte

gonna / modesty panel / voile de fond
ME 75
melaminico noce natural
natural walnut melamine
mélaminé noyer naturelle

modular unit
ME 75
melaminico noce natural
natural walnut melamine
mélaminé noyer naturelle

« MIXED COLORS »

02

IT— In legno melaminico noce natural e struttura color basalto, la scrivania è abbinata al mobile modular unit, che offre ampie possibilità di personalizzazione. A completare, armadio Profbox con nuove ante rail dal profilo metallico in alluminio anodizzato nero e vetro fumé. Internamente è attrezzato con ripiani in vetro e luce led. Nelle pagine seguenti, area attesa con tavolini caffè dalla forma rotonda e ovale con piano in melaminico noce natural, vetro anti touch e struttura color basalto. Caratterizza lo spazio la libreria Profcase in noce natural presentata nelle nuove modularità e con i nuovi accessori fermalibri disponibili in varie finiture.

EN— In natural walnut melamine wood and a basalt colored structure, the desk is combined with the modular unit, which offers ample possibilities for customization. To complete, Profbox wardrobe with new rail doors with a black anodized metal aluminum profile and smoked glass. Internally it is equipped with glass shelves and led light. In the following pages, waiting area with coffee tables with round and oval shape with natural walnut melamine top, anti touch glass and basalt colored structure. The Profcase bookcase in natural walnut is featured in the new modularity and with the new bookend accessories available in various finishes.

F— En bois mélaminé noyer naturel et dans une structure colorée basalte, le bureau est associé à le modular unit, qui offre de nombreuses possibilités de personnalisation. Pour compléter, la garde-robe Profbox avec de nouvelles portes de rail avec un profil en aluminium anodisé noir et en verre fumé. En interne, il est équipé d'étagères en verre et de lumière led. Dans les pages suivantes, salle d'attente avec tables basses de forme ronde et ovale avec plateau en mélaminé noyer naturel, verre anti empreintes et structure en couleur basalte. La bibliothèque Profcase en noyer naturel est présentée dans la nouvelle modularité et avec les nouveaux accessoires de bibliothèque disponibles dans différentes finitions.



DESK — 2505 x 2100 x H 740 mm



PROFBOX — 1836 x 470 x H 2116 mm



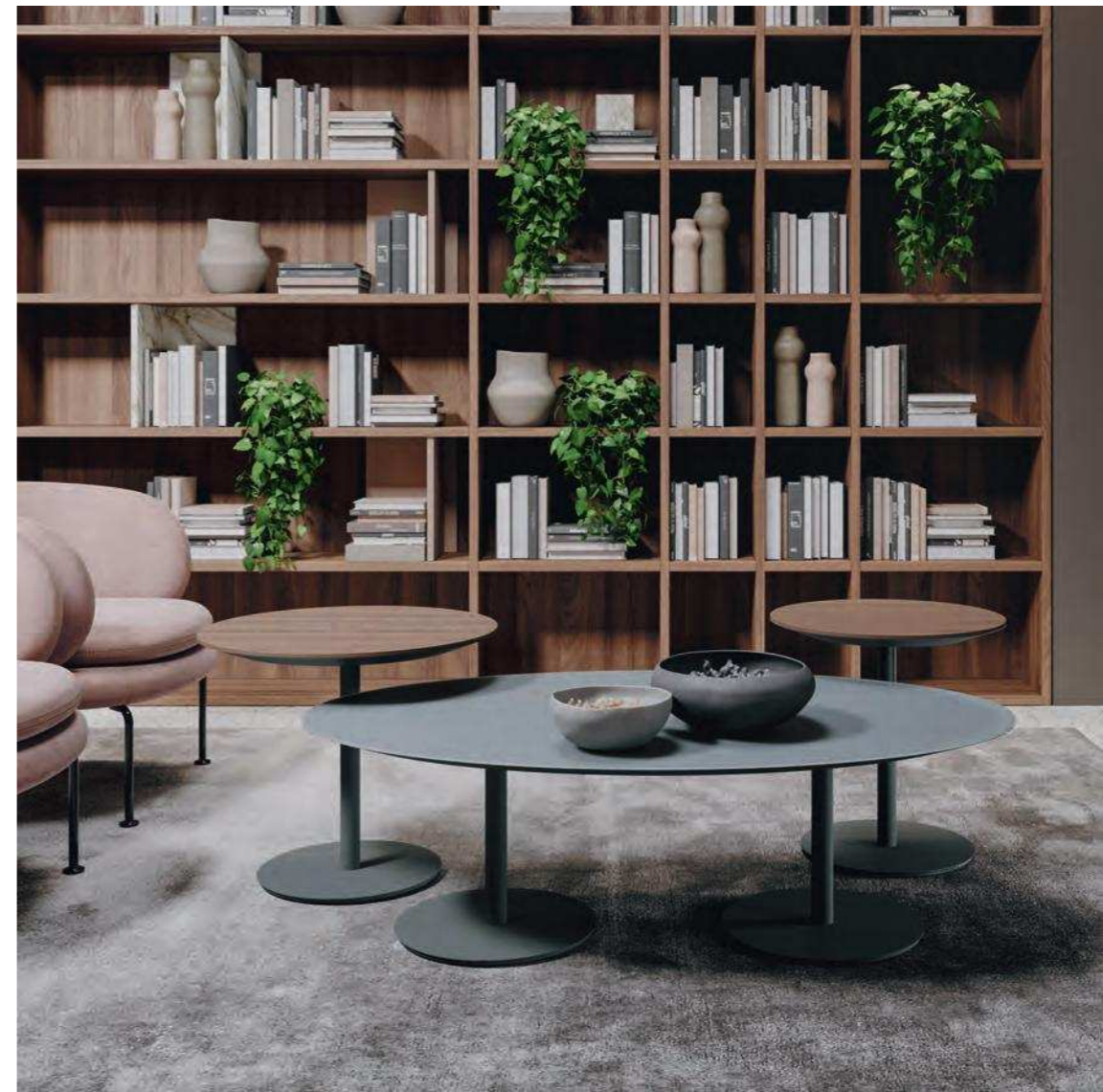

COFFEE TABLES — 1300 x 800 x H 400 mm / Ø 500 x H 500 mm / Ø 600 x H 500 mm

**piano / top / plateau**

SA 1944
 vetro stampato anti touch stone grey
 stone grey anti touch printed glass
 verre imprimé anti empreintes stone grey

struttura / structure / structure

MO1 9010
 metallo verniciato opaco bianco
 white matt varnished metal
 métal verni mat blanc

« MIXED COLORS »

03

IT— La scrivania con dattilo è proposta con piano in vetro anti touch stone grey accostato al bianco opaco della struttura metallica. A fianco, la libreria Profcase in un'inedita composizione con nuovi inserti colorati, giocata nelle tonalità grigio chiaro e verde oliva. Nelle pagine successive, tavolo riunione con piano in vetro anti touch stone grey, struttura bianca e passacavo Profcable con pannello in tinta. Nelle stesse tonalità e finiture, i contenitori Profbox con ante, top e fianchi in vetro anti touch stone grey.

EN— The desk is in the version with extension and glass top anti touch stone grey matched with the matt white of the metal structure. Beside, the Profcase bookcase in a new composition with new colored inserts, played in light grey and olive green tones. In the following pages, square meeting table with stone grey brilliant glass top, white structure and Profcable in the same color. In the same shades and finishes, the Profbox containers with doors, tops and sides in anti touch stone grey glass.

F— Le bureau est dans la version avec extension et plateau en verre anti empreintes stone grey contact assorti au blanc mat de la structure métallique. À côté, la bibliothèque Profcase dans une nouvelle composition avec de nouveaux inserts colorés, jouée dans des tons gris clair et vert olive. Dans les pages suivantes, table de réunion carrée avec plateau en verre brillant stone grey, structure blanche et passe-câble Profcable de la même couleur. Dans les mêmes tons et finitions, les conteneurs Profbox avec portes, plans et côtés en verre anti empreintes stone grey.



DESK — 2240 x 2000 x H 740 mm

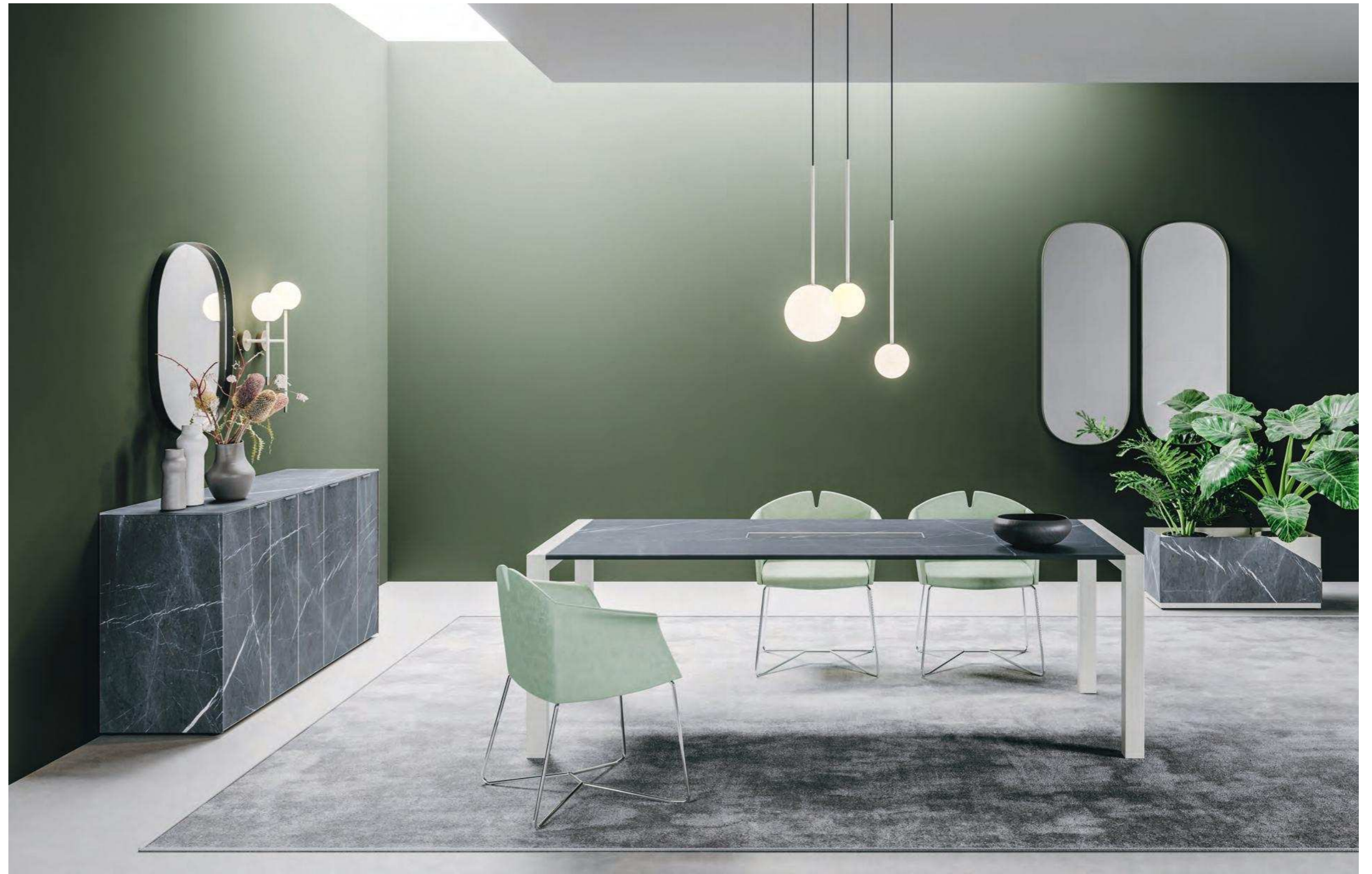

MEETING TABLE — 2440 x 1230 x H 740 mm



PROFBOX — 1820 x 470 x H 860 mm





« TECHNICALS »

IM - IMPIALLACCIATO LEGNO / WOOD VENEER / PLAQUÉ BOIS



44
noce Canaletto
walnut Canaletto
noyer Canaletto

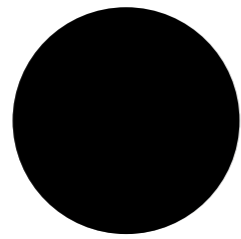

50
rovere termotrattato
thermotreated oak
chêne traité thermiquement

FX - FENIX NTM® / FENIX NTM® / FENIX NTM®

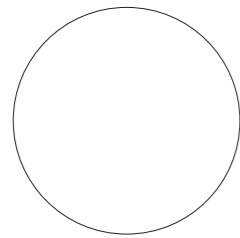

0032
bianco
white
blanc

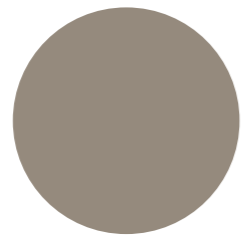

0717
castoro
beaver
castor

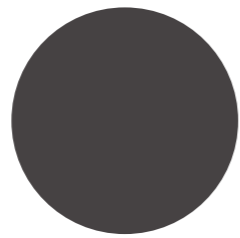

0749
cacao
cocoa
cacao

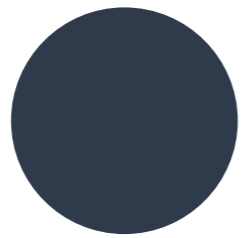

0754
blu scuro
dark blue
bleu foncé

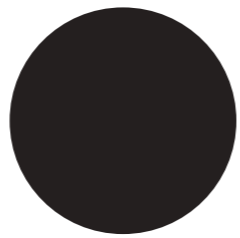

0720
nero
black
noir

ME - MELAMINICO / MELAMINE / MÉLAMINÉ



70
olmo
elm
orme



75
noce natural
natural walnut
noyer naturelle



77
noce dark
dark walnut
noyer foncé

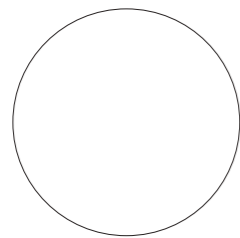

20
bianco
white
blanc



01
grigio chiaro
light grey
gris clair

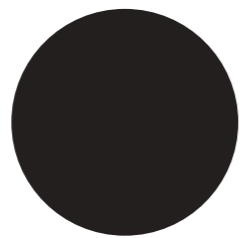

04
nero
black
noir

MC - COLORE MELAMINICO / MELAMINE COLOR / COULEUR MÉLAMINÉE

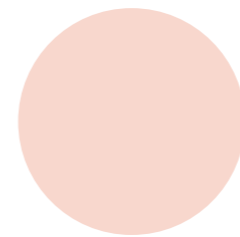

31
cipria
powder
poudre

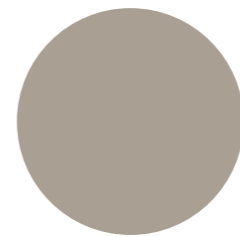

26
beige
beige
beige

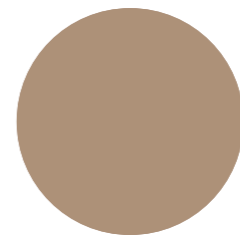

23
cappuccino
cappuccino
cappuccino

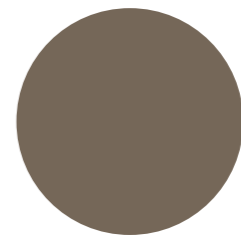

25
tabacco
tobacco
tabac

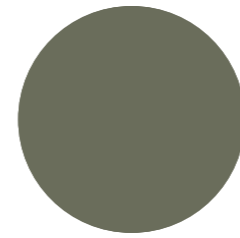

24
verde oliva
olive green
vert olive

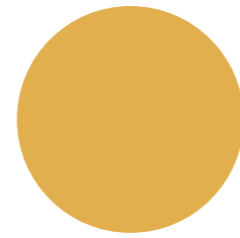

32
curry
curry
curry

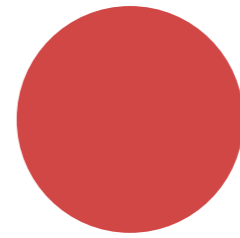

29
rosso oriente
orient red
rouge orient

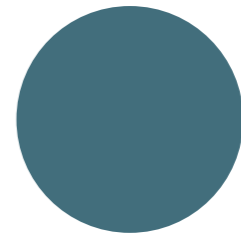

33
petrolio
petroleum
pétrole

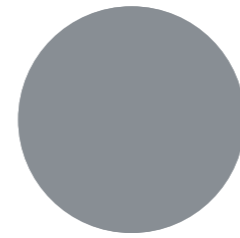

34
grigio perla
pearl grey
gris perle

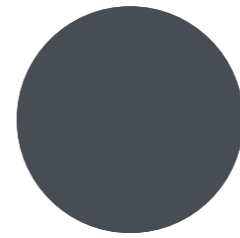

30
basalto
basalt
basalte

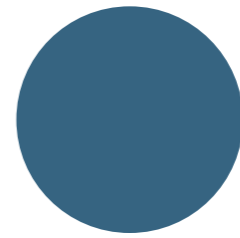

35
blu sea
blue sea
mer bleue

SB - VETRO STAMPATO BRILLANTE / BRILLIANT PRINTED GLASS / VERRE IMPRIMÉ BRILLANT

SA - VETRO STAMPATO ANTI TOUCH / ANTI TOUCH PRINTED GLASS / VERRE IMPRIMÉ ANTI EMPREINTES



0770
Calacatta oro
Calacatta gold
Calacatta or



2069
Emperador dark
Emperador dark
Emperador dark



1944
stone grey
stone grey
stone grey

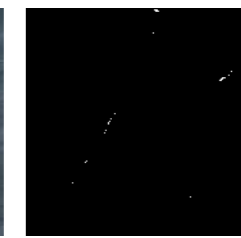

1377
nero Marquina
black Marquina
noir Marquina

VB - VETRO LACCATO BRILLANTE / BRILLIANT LACQUERED GLASS / VERRE LAQUÉ BRILLANT

VA - VETRO LACCATO ANTI TOUCH / ANTI TOUCH LACQUERED GLASS / VERRE LAQUÉ ANTI EMPREINTES

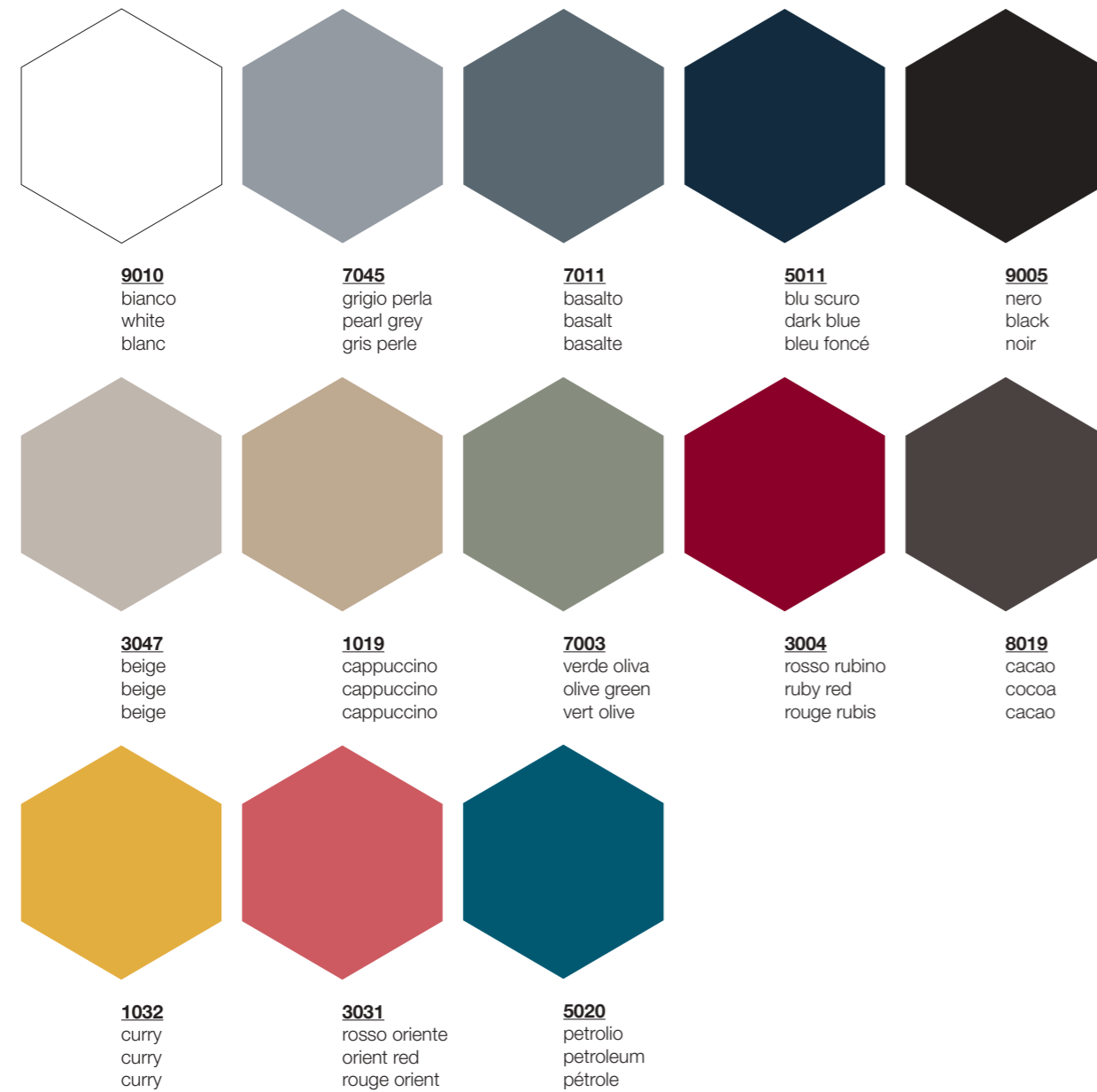

MO1 - METALLO VERNICIATO OPACO / MATT VARNISHED METAL / MÉTAL VERNI MAT

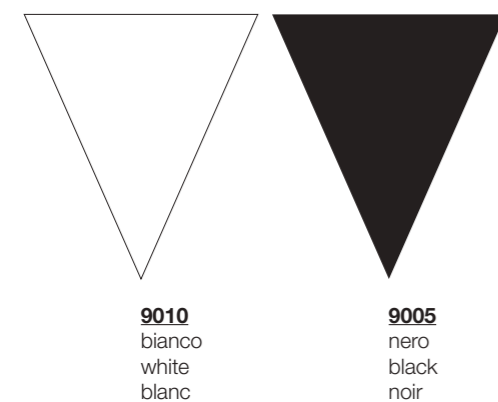

MO2 - METALLO VERNICIATO OPACO / MATT VARNISHED METAL / MÉTAL VERNI MAT

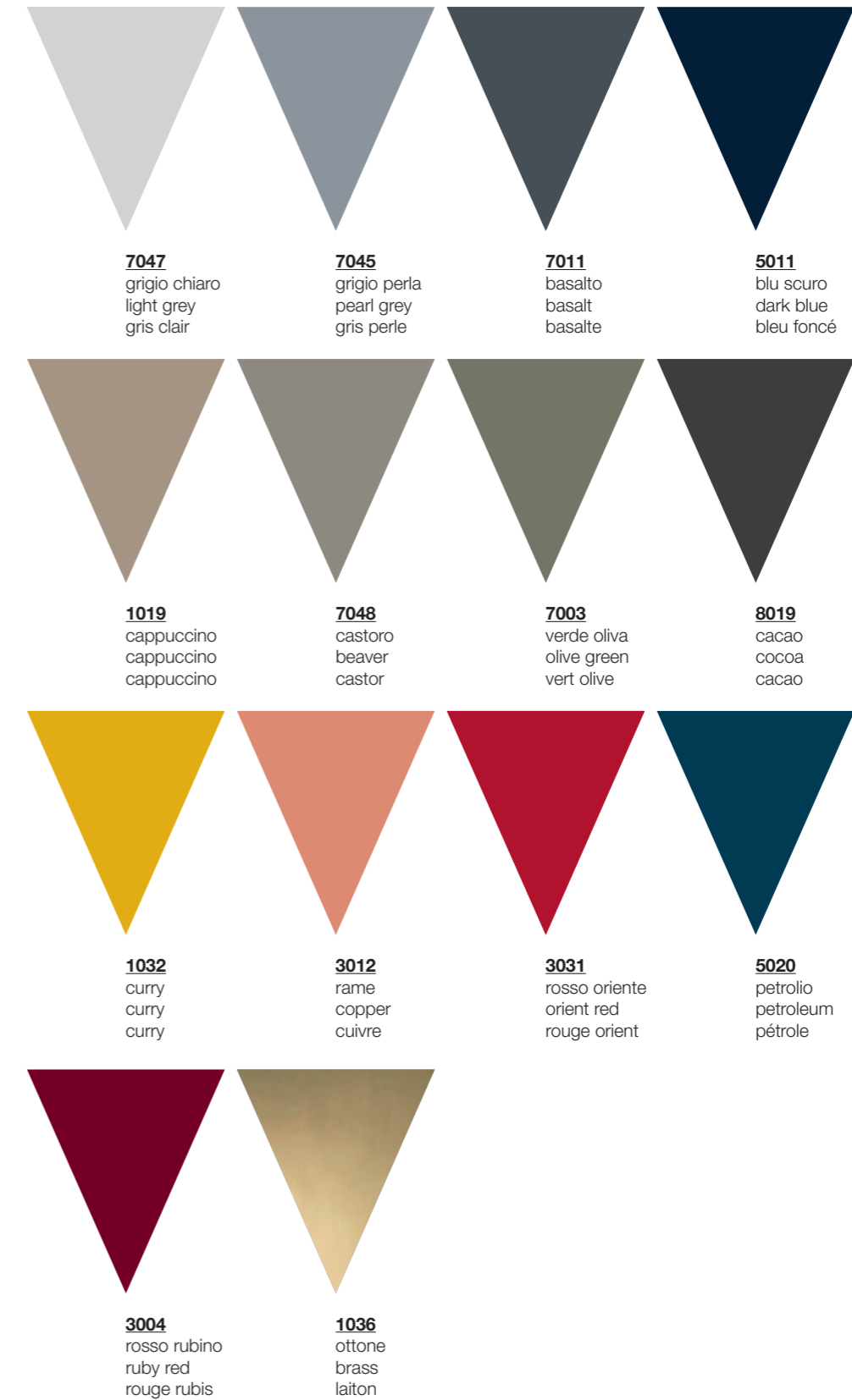



MO1
MO2

ME
MC
IM
FX
VA/VB + ME
SA/SB + ME

ME
MC
IM
FX
VA/VB + ME
SA/SB + ME

ME
MC
IM
FX

STRUTTURA / STRUCTURE / STRUCTURE

IT— Le gambe sono realizzate in tubolari di acciaio 70x70mm, verniciate opache a polveri epossidiche con piedini livellatori in abs.

EN— The legs are made of 70x70 mm steel tubes in matt metal finishes with epoxy powders and leveling feet in abs.

F— Les pieds sont constitués de tubes d'acier de 70x70mm, peints avec des poudres époxydiques avec des pieds réglables en abs.

MO1 - METALLO VERNICIATO OPACO / MATT VARNISHED METAL / MÉTAL VERNI MAT



MO2 - METALLO VERNICIATO OPACO / MATT VARNISHED METAL / MÉTAL VERNI MAT



PIANO / TOP / PLATEAU

IT— Il piano può essere in legno da 18/19 mm o in vetro con uno spessore totale di 18 mm composto da una lastra in vetro di 4 mm incollata su supporto melaminico bianco o nero sp. 14 mm con bordo in tinta con il piano.

EN— The top can be in 18/19 mm wood or in glass with a total thickness of 18 mm composed of a 4 mm glass plate glued on a white or black melamine top 14 mm th. with edge matching the top.

F— Le plateau peut être en bois de 18/19 mm ou en verre d'une épaisseur totale de 18 mm composé d'une plaque de verre de 4 mm collé sur un plateau mélaminé blanc ou noir ép. 14 mm avec le bord correspondant au plateau.



ME
MC
IM
FX

VA/VB + ME
SA/SB + ME

ME - MELAMINICO / MELAMINE / MÉLAMINÉ



MC - COLORE MELAMINICO / MELAMINE COLOR / COULEUR MÉLAMINÉE



IM - IMPIALLACCIATO LEGNO / WOOD VENEER / PLAQUÉ BOIS



FX - FENIX NTM® / FENIX NTM® / FENIX NTM®



VB - VETRO LACCATO BRILLANTE / BRILLIANT LACQUERED GLASS / VERRE LAQUÉ BRILLANT

VA - VETRO LACCATO ANTI TOUCH / ANTI TOUCH LACQUERED GLASS / VERRE LAQUÉ ANTI EMPREINTES



SB - VETRO STAMPATO BRILLANTE / BRILLIANT PRINTED GLASS / VERRE IMPRIMÉ BRILLANT

SA - VETRO STAMPATO ANTI TOUCH / ANTI TOUCH PRINTED GLASS / VERRE IMPRIMÉ ANTI EMPREINTES

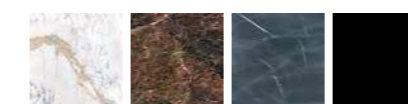

SCRIVANIA
DESK
BUREAU

IT— La scrivania ha una struttura composta da due gambe a portale realizzate in tubolari di acciaio 70x70 mm nelle finiture metallo opaco. I piani possono essere in legno impiallacciato, Fenix NTM®, melaminico con pannelli spessore di 18/19 mm o in vetro spessore totale 18 mm con lastre di 4 mm su supporto melaminico bianco o nero sp. 14 mm con bordo in tinta con il piano. Su richiesta è disponibile la gonna di altezza 360 mm nelle stesse finiture del piano.

EN— The desk has a structure composed of two portal legs made of 70x70 mm steel tubes in matt metal finishes. The tops can be in wood veneer, Fenix NTM®, melamine with 18/19 mm thick panels or in glass with a total thickness of 18 mm with 4 mm slabs glued on a white or black melamine top 14 mm th. with edge matching the top. On request the 360 mm high modesty panel is available in the same finishes as the top.

F— Le bureau a une structure composée de deux pieds de portail en tubes d'acier de 70 x 70 mm aux finitions en métal mat. Les plateaux peuvent être en bois plaqué, Fenix NTM®, en mélamine avec des panneaux d'une épaisseur de 18/19 mm ou en verre d'une épaisseur totale de 18 mm avec des feuilles de 4 mm collé sur un plateau mélaminé blanc ou noir ép. 14 mm avec le bord correspondant au plateau. Sur demande la voile de fond haute de 360 mm est disponible dans les mêmes finitions que le plateau.

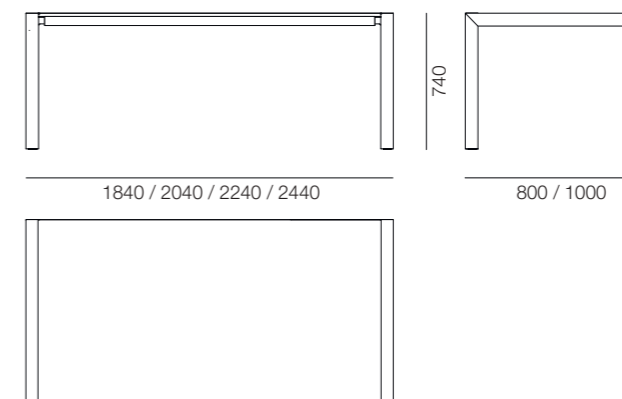
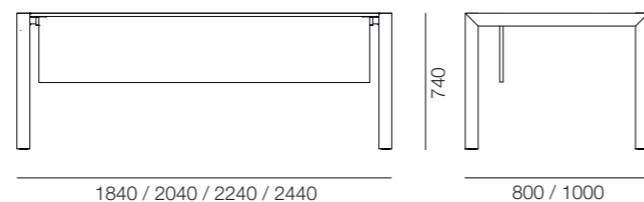

SCRIVANIA + DATTILO
DESK + EXTENSION
BUREAU + EXTENSION

IT— La scrivania ha una struttura composta da tre gambe a portale realizzate in tubolari di acciaio 70x70 mm nelle finiture metallo opaco, di cui una speciale dedicata per supportare il piano dattilo. I piani possono essere in legno impiallacciato, Fenix NTM®, melaminico con pannelli spessore di 18/19 mm o in vetro spessore totale 18 mm con lastre di 4 mm su supporto melaminico bianco o nero sp. 14 mm con bordo in tinta con il piano. Su richiesta è disponibile la gonna di altezza 360 mm nelle stesse finiture del piano.

EN— The desk has a structure composed of three portal legs made of 70x70 mm steel tubes in matt metal finishes, one of which is dedicated to supporting the extension table top. The tops can be in wood veneer, Fenix NTM®, melamine with 18/19 mm thick panels or in glass with a total thickness of 18 mm with 4 mm slabs glued on a white or black melamine top 14 mm th. with edge matching the top. On request the 360 mm high modesty panel is available in the same finishes as the top.

F— Le bureau a une structure composée de trois pieds à portail en tubes d'acier de 70 x 70 mm aux finitions en métal mat, dont l'un est dédié au support du plateau de table. Les plateaux peuvent être en bois plaqué, Fenix NTM®, en mélamine avec des panneaux d'une épaisseur de 18/19 mm ou en verre d'une épaisseur totale de 18 mm avec des feuilles de 4 mm collé sur un plateau mélaminé blanc ou noir ép. 14 mm avec le bord correspondant au plateau. Sur demande la voile de fond haute de 360 mm est disponible dans les mêmes finitions que le plateau.

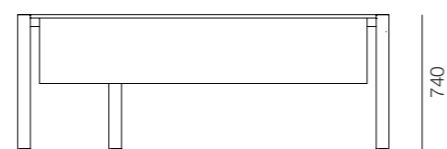

1840 / 2040 / 2240 / 2440

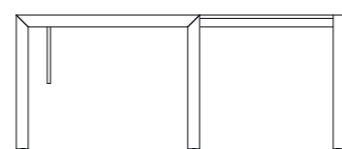

1600 / 2000

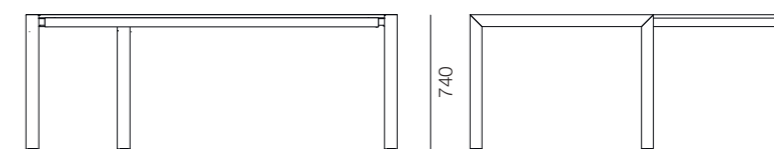

1840 / 2040 / 2240 / 2440

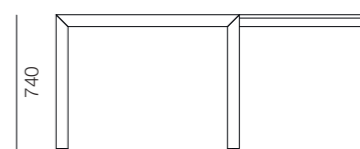

1600 / 2000

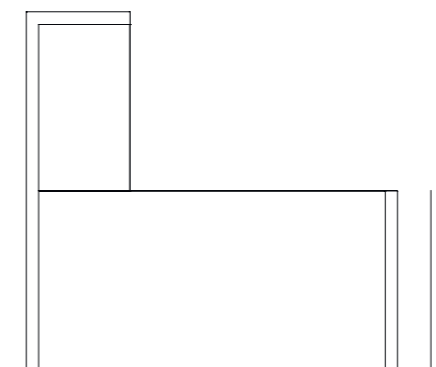

800 / 1000

SCRIVANIA + MODULAR UNIT
DESK + MODULAR UNIT
BUREAU + MODULAR UNIT

IT— La scrivania ha una struttura composta da due gambe a portale realizzate in tubolari di acciaio 70x70 mm nelle finiture metallo opaco, di cui una speciale in appoggio su modular unit. I piani possono essere in legno impiallacciato, Fenix NTM®, melaminico con pannelli spessore di 18/19 mm o in vetro spessore totale 18 mm con lastre di 4 mm su supporto melaminico bianco o nero sp. 14 mm con bordo in tinta con il piano. Su richiesta è disponibile la gonna di altezza 360 mm nelle stesse finiture del piano. Il modular unit è un mobile contenitore composto da elementi modulari liberamente accostabili tra loro in profondità 600 mm e in due larghezze 416 mm e 832 mm. Si può scegliere il modulo a giorno, porta cpu, chiuso con anta, a 1 cassetto e classificatore, a 3 cassetti, con maniglia o push to open. È disponibile anche il modulo con vani a giorno di testa iniziale o finale.

EN— The desk has a structure composed of two portal legs made of 70x70 mm steel tubes in matt metal finishes, of which a special one rests on a modular unit. The tops can be in veneered wood, Fenix NTM®, melamine with 18/19 mm thick panels or in glass with a total thickness of 18 mm with 4 mm slabs glued on a white or black melamine top 14 mm th. with edge matching the top. On request the 360 mm high modesty panel is available in the same finishes as the top. The modular unit is a storage unit composed of modular elements freely accessible together at a depth of 600 mm and in two widths 416 mm and 832 mm. You can choose the open module, cpu holder, closed with door, 1 drawer and filing cabinet, 3 drawers, with handle or push to open. The module with the open compartments at the beginning and at the end is also available.

F— Le bureau a une structure composée de deux pieds à portail en tubes d'acier de 70x70 mm en finitions métal mat, dont l'un spécial repose sur un modular unit. Les plateaux peuvent être en bois plaqué, Fenix NTM®, en mélamine avec des panneaux de 18/19 mm d'épaisseur ou en verre de 18 mm d'épaisseur avec des plaques de 4 mm collé sur un plateau mélaminé blanc ou noir ép. 14 mm avec le bord correspondant au plateau. Sur demande la voile de fond haute de 360 mm est disponible dans les mêmes finitions que le plateau. Le modular unit est une unité de stockage composée d'éléments modulaires librement accessibles entre eux à une profondeur de 600 mm et en deux largeurs de 416 mm et 832 mm. Vous pouvez choisir le module ouvert, le support du processeur, fermé avec porte, 1 tiroir et classeur, 3 tiroirs, avec poignée ou bouton poussoir pour ouvrir. Le module avec des espaces ouverts initial ou final est également disponible.

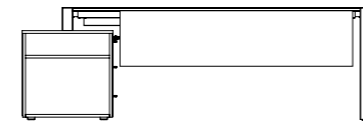

2105 / 2305 / 2505 / 2705

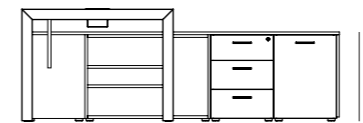

2100

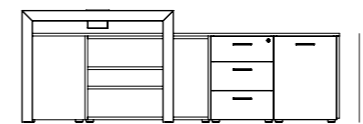

2100

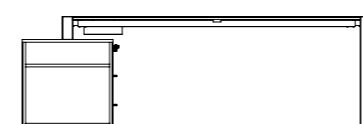
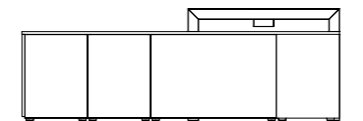

2105 / 2305 / 2505 / 2705

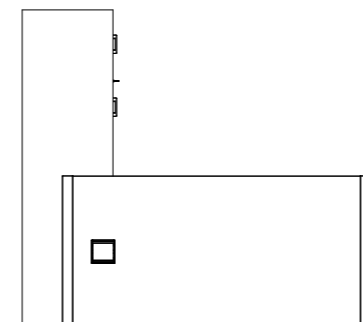



PASSAGGIO CAVI SCRIVANIA
DESK CABLE MANAGEMENT
PASSAGE DES CÂBLES BUREAU

IT— La scrivania può essere dotata di un piccolo carter in tinta fissato ad una gamba tramite dei magneti per agevolare e nascondere il passaggio verticale dei cavi e una vasca per la canalizzazione orizzontale. Il piano può avere un passacavo Proficable rettangolare o quadrato in finitura anodizzata alluminio, nero, ottone o verniciato bianco con sportello apribile in tinta con il piano. È prevista anche la possibilità di installare un caricatore wireless a scomparsa totale nel piano. Il modular unit è attrezzabile su richiesta con il medesimo passacavo.

EN— The desk can be equipped with a small colored carter fixed to one leg by magnets to facilitate and hide the vertical passage of the cables and a carter for horizontal cabling. The top can have a rectangular or square Proficable in anodized aluminum, black, brass or white painted finish with an openable door in the same color as the top. There is also the possibility of installing a fully concealed wireless charger in the plan. The modular unit can be equipped on request with the same cable tidy.

F— Le bureau peut être équipé d'un petit carter coloré fixé à une jambe par des aimants pour faciliter et masquer le passage vertical des câbles et d'un réservoir pour canalisation horizontale. Le plateau peut comporter un passe-câble Proficable rectangulaire ou carré en aluminium anodisé, peint en noir, en laiton ou en blanc avec une porte ouvrable de la même couleur que le plateau. Il est également possible d'installer un chargeur sans fil entièrement dissimulé dans le plan. Le modular unit peut être équipée sur demande du même passe-câble.

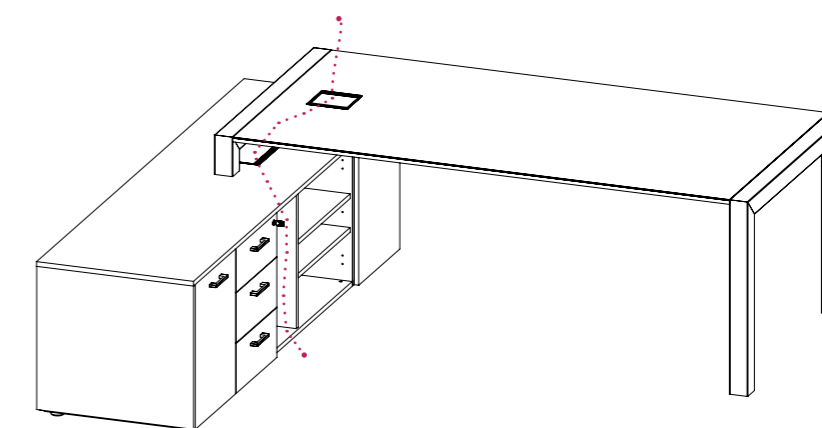
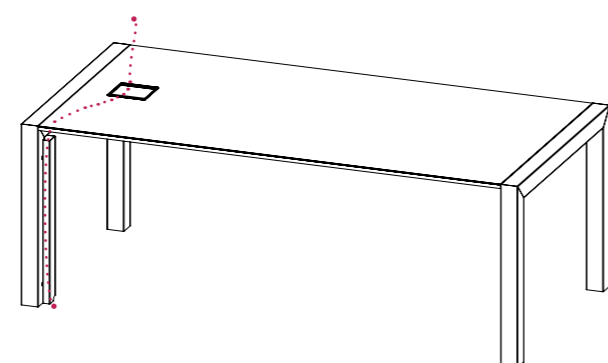

TAVOLO RIUNIONE
MEETING TABLE
TABLE DE RÉUNION

IT— Il tavolo riunione è previsto in profondità 1000/1230 mm ed ha una struttura composta da due gambe a portale realizzate in tubolari di acciaio 70x70 mm nelle finiture metallo opaco. I piani possono essere in legno impiallacciato, Fenix NTM®, melaminico con pannelli spessore di 18/19 mm o in vetro spessore totale 18 mm con lastre di 4 mm su supporto melaminico bianco o nero sp. 14 mm con bordo in tinta con il piano.

EN— The meeting table is available in depths 1000/1230 mm and has a structure composed of two portal legs made of 70x70 mm steel tubes in matt metal finishes. The tops can be in wood veneer, Fenix NTM®, melamine with 18/19 mm thick panels or in glass with a total thickness of 18 mm with 4 mm slabs glued on a white or black melamine top 14 mm th. with edge matching the top.

F— La table de réunion est disponible en profondeurs: 1000/1230 mm et a une structure composée de deux pieds de portail en tubes d'acier de 70x70 mm avec des finitions en métal mat. Les plateaux peuvent être en bois plaqué, Fenix NTM®, en mélamine avec des panneaux d'une épaisseur de 18/19 mm ou en verre d'une épaisseur totale de 18 mm avec des feuilles de 4 mm collé sur un plateau mélaminé blanc ou noir ép. 14 mm avec le bord correspondant au plateau.

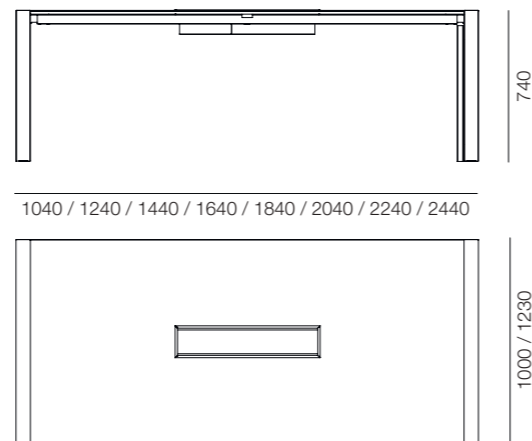

TAVOLO RIUNIONE MODULARE
MODULAR MEETING TABLE
TABLE DE RÉUNION MODULAIRE

IT— Il tavolo riunione modulare è composto da piani componibili in profondità 1230 mm con gamba centrale condivisa per la canalizzazione verticale.

EN— The modular meeting table is composed of modular tops in depth 1230 mm with a central shared leg for vertical channeling.

F— La table de réunion modulaire est composée de plans de travail modulables à profondeur de 1230 mm avec un pied central partagé pour une canalisation verticale.

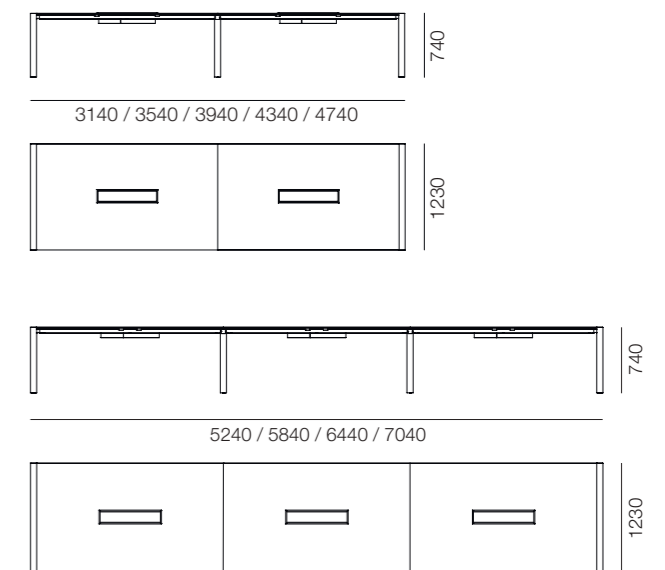

TAVOLO RIUNIONE
MEETING TABLE
TABLE DE RÉUNION

IT— Il tavolo riunione è previsto in profondità 1630 mm ed ha una struttura composta da due gambe a portale realizzate in tubolari di acciaio 70x70 mm nelle finiture metallo opaco. I piani possono essere in legno impiallacciato, Fenix NTM®, melaminico con pannelli spessore di 18/19 mm o in vetro spessore totale 18 mm con lastre di 4 mm su supporto melaminico bianco o nero sp. 14 mm con bordo in tinta con il piano.

EN— The meeting table is available in depth 1630 mm and has a structure composed of two portal legs made of 70x70 mm steel tubes in matt metal finishes. The tops can be in wood veneer, Fenix NTM®, melamine with 18/19 mm thick panels or in glass with a total thickness of 18 mm with 4 mm slabs glued on a white or black melamine top 14 mm th. with edge matching the top.

F— La table de réunion est disponible en profondeur 1630 mm et a une structure composée de deux pieds de portail en tubes d'acier de 70x70 mm avec des finitions en métal mat. Les plateaux peuvent être en bois plaqué, Fenix NTM®, en mélamine avec des panneaux d'une épaisseur de 18/19 mm ou en verre d'une épaisseur totale de 18 mm avec des feuilles de 4 mm collé sur un plateau mélaminé blanc ou noir ép. 14 mm avec le bord correspondant au plateau.

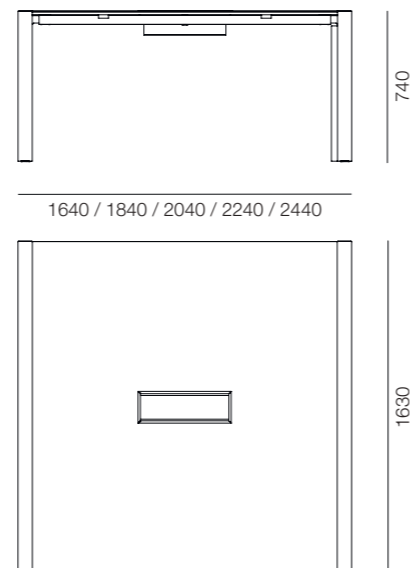

TAVOLO RIUNIONE MODULARE
MODULAR MEETING TABLE
TABLE DE RÉUNION MODULAIRE

IT— Il tavolo riunione modulare è composto da piani componibili in profondità 1630 mm con gamba centrale condivisa per la canalizzazione verticale.

EN— The modular meeting table is composed of modular tops in depth 1630 mm with a central shared leg for vertical channeling.

F— La table de réunion modulaire est composée de plans de travail modulables à profondeur de 1630 mm avec un pied central partagé pour une canalisation verticale.

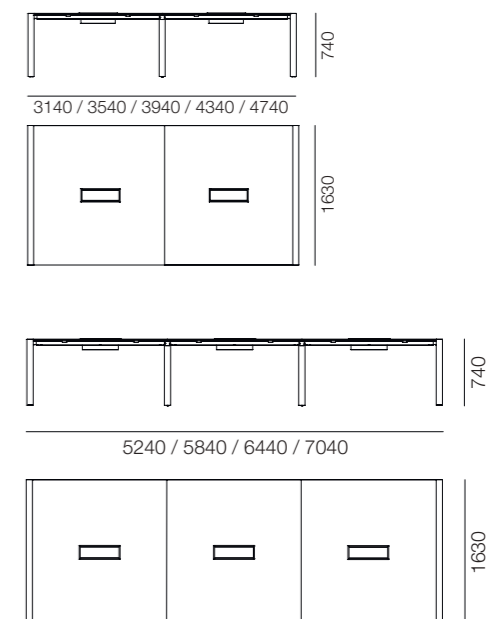



PASSAGGIO CAVI TAVOLO RIUNIONE
CABLE MANAGEMENT MEETING TABLE
PASSAGE DES CÂBLES TABLE DE RÉUNION

IT— Il tavolo riunione può essere dotato di un piccolo carter in tinta fissato ad una gamba con magneti per agevolare e nascondere il passaggio verticale dei cavi e una vasca per la canalizzazione orizzontale. Il piano può avere un passacavo metallico rettangolare Proficable in diverse lunghezze in finitura anodizzata alluminio, nero, ottone o verniciato bianco con sportello apribile in tinta con il piano.
 Il tavolo riunione modulare ha una gamba centrale per la canalizzazione verticale.

EN— The meeting table can be equipped with a small colored carter fixed to one leg with magnets to facilitate and hide the vertical passage of the cables and a carter for horizontal cabling. The top can have a rectangular metal cable tidy in different lengths in anodized aluminum, black, brass or white painted finish with an openable door in the same color as the top.
 The modular meeting table has a central leg for vertical ducting.



F— La table de réunion peut être équipée d'un petit carter coloré fixé à une jambe avec des aimants pour faciliter et masquer le passage vertical des câbles et d'un réservoir pour un cablage horizontal. Le dessus peut comporter un passe cable rectangulaire en métal de différentes longueurs, en aluminium anodisé, peint en noir, en laiton ou en blanc, avec un top pouvant être ouverte de la même couleur que le dessus.
 La table de réunion modulaire a un pied central pour le cablage vertical.

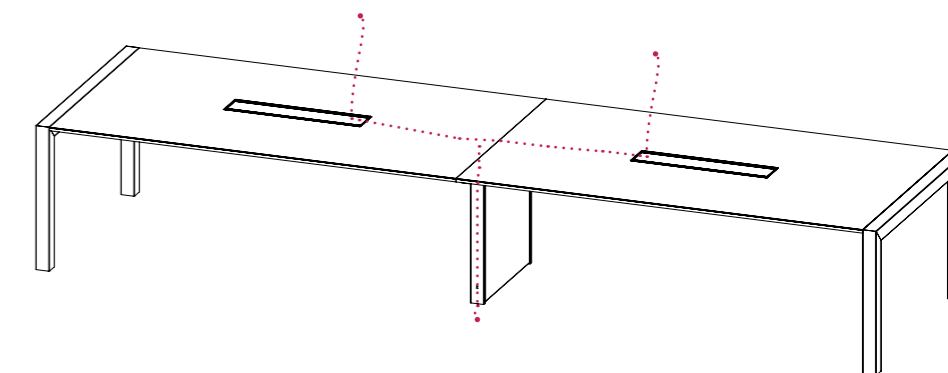

TAVOLO RIUNIONE ROTONDO + INSERTO CENTRALE
ROUND MEETING TABLE + CENTRAL INSERT
TABLE DE RÉUNION RONDE + INSERT CENTRAUX

IT— Tavolo con base cilindrica metallica disponibile in finitura verniciata opaco. Il piano è rotondo con bordo a saponetta, previsto in legno e vetro. Centralmente è caratterizzato da un inserto rotondo che può essere dotato di un meccanismo elettrico di sollevamento. Una volta alzato dà accesso ad un comodo vano elettrificato con prese multiple.

EN— Round meeting table with cylindrical metal base available in matt painted finish. The top is round with rounded edges, available in wood and glass. Centrally it is characterized by a round insert that can be equipped with an electric lifting mechanism. Once raised it gives access to a convenient electrified compartment with multiple sockets.

F— Table de réunion ronde avec base en métal cylindrique disponible en finition peinte mate. Le plateau est rond avec des bords arrondis, disponible en bois et en verre. Au centre, il est caractérisé par un insert rond pouvant être équipé d'un mécanisme de levage électrique. Une fois soulevé, il donne accès à un compartiment électrifié pratique avec plusieurs prises.

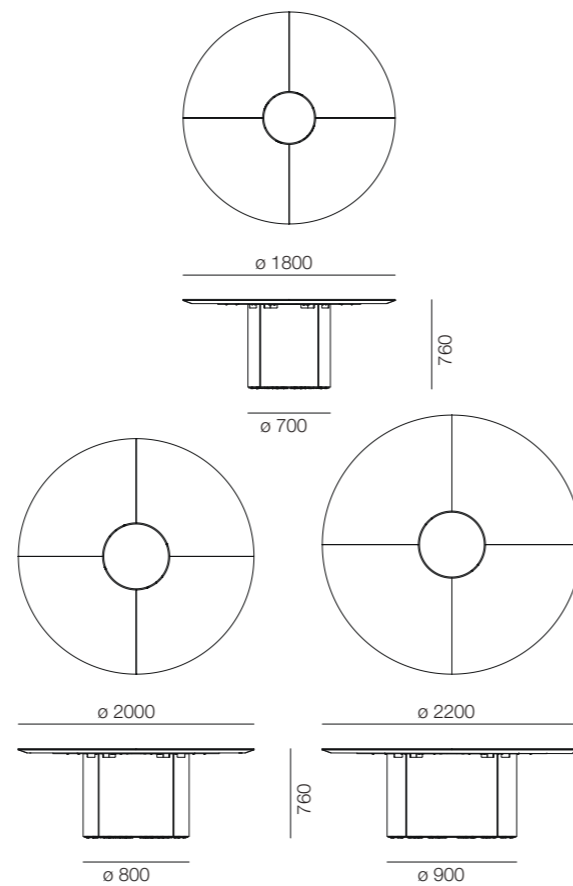

TAVOLO RIUNIONE ROTONDO
ROUND MEETING TABLE
TABLE DE RÉUNION RONDE

IT— Tavolo con base cilindrica metallica disponibile in finitura verniciata opaco. Il piano è rotondo con bordo a saponetta, previsto in legno e vetro, fornito di serie con passacavo rotondo.

EN— Round meeting table with cylindrical metal base available in matt painted finish. The top is round with rounded edges, available in wood and glass, with production round cable tidy.

F— Table de réunion ronde avec base en métal cylindrique disponible en finition peinte mate. Le plateau est rond avec des bords arrondis, disponible en bois et en verre, livré avec passe câble rond.

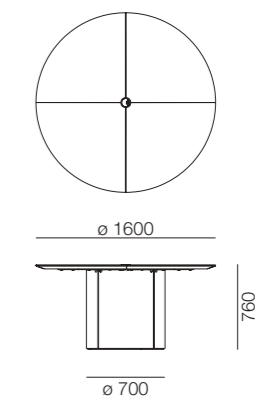

creative & design direction
RMDESIGNSTUDIO / Mariella Vidotti

graphic design & copywriting
RMDESIGNSTUDIO

product design
R&S PROF

photos
concept, set design & styling / RMDESIGNSTUDIO
rendering & styling / SALAPOSA STUDIO

printed in Italy
AGCM / PN
September 2019

L'azienda si riserva in qualunque momento di apportare senza preavviso modifiche a prodotti, accessori e finiture.

The Manufacturer reserves the right to modify products, accessories and finishings at any time without prior notice.

La Société se réserve le droit à tout moment de faire des changements sans préavis aux produits, accessoires et finitions.

Prof srl - Azienda certificata / Certified Company / Entreprise certifiée



**PR
OF**

PROF srl
Via Cao de Villa 6/A
Località Falzè di Piave
31020 Sernaglia della Battaglia, TV / Italy
T +39 0438 903190 F +39 0438 903228
p.iva / cod.fisc IT03134570260
www.profoffice.it info@profoffice.it

