

DODICI

working system



**PR
OF**

DODICI

working system

—

**PR
OF**

« CONTENTS »

PAG. 04
CHAPTER 01 - THE COLLECTION

PAG. 06
CHAPTER 02 - THE CATALOGUE

PAG. 08
CHAPTER 03 - PROJECT 01

PAG. 22
CHAPTER 04 - PROJECT 02

PAG. 34
CHAPTER 05 - PROJECT 03

PAG. 46
CHAPTER 06 - PROJECT 04

PAG. 58
CHAPTER 07 - PROJECT 05

PAG. 70
CHAPTER 08 - PROJECT 06

PAG. 84
CHAPTER 09 - TECHNICALS



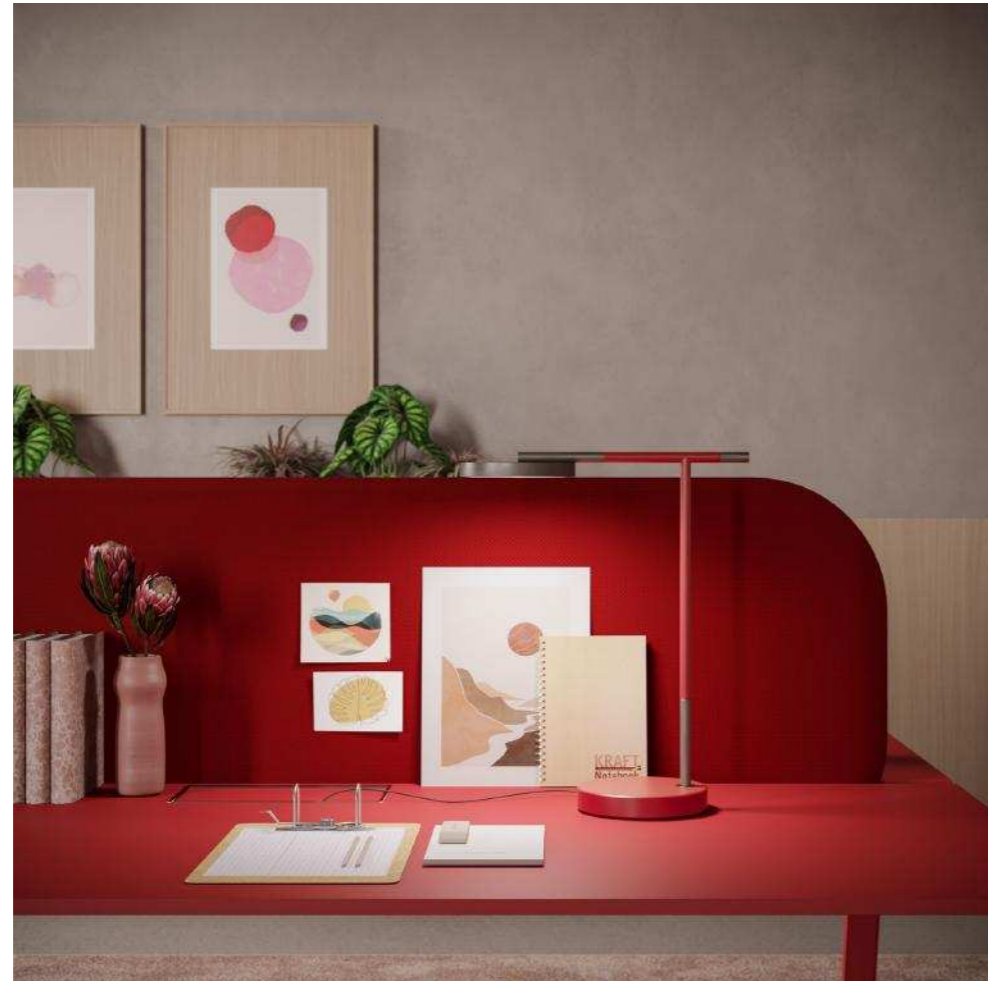

« THE COLLECTION »

IT— DODICI è una collezione di scrivanie e tavoli riunione dal carattere estremamente versatile per declinarsi in spazi operativi e manager. È caratterizzata da una struttura metallica verniciata opaca dal disegno leggero ed essenziale, in perfetta armonia con i piani disponibili in melaminico, vetro laccato anti touch e brillante in tinta unita o stampato effetto marmo, laccato, Fenix e legno impiallacciato. Le diverse configurazioni, personalizzabili grazie all'ampia varietà di colori e finiture, sono in grado di interpretare stili differenti in ambienti lavorativi ed home office. La SCRIVANIA MANAGER viene proposta con o senza gonna in versione semplice, con piano dattilo o in alternativa su Modular unit. Le SCRIVANIE OPERATIVE vanno dalle composizioni semplici fino alle lunghe workstation condivise e possono essere integrate ai contenitori Modular unit e alle partizioni divisorie Openwall. I TAVOLI RIUNIONE rettangolari sono previsti in varie profondità e possono essere composti in configurazioni con gamba centrale condivisa per la canalizzazione verticale. Completano la collezione una selezione di accessori come gli screen per aumentare il comfort acustico, le cassettiere su ruote e tutte le dotazioni tecnologiche come passacavi e porta cpu. Personalizzano gli ambienti le collezioni di contenitori, mobili di servizio e complementi tutti perfettamente abbinati nei materiali e nelle tonalità.

EN— DODICI is a collection of desks and meeting tables with an extremely versatile character to use in operative and managerial spaces. It is characterised by a matt varnished metal structure with a light and essential design, in perfect harmony with the tops available in melamine, anti touch and glossy lacquered glass in solid colours or printed with marble effect, lacquered, Fenix and wood veneer. The different configurations, customisable thanks to the wide variety of colours and finishes, are able to interpret different styles in work and home office environments. The MANAGER DESK is available with or without a modesty panel in a simple version, with an extension top or alternatively on a Modular unit. The WORKING DESKS range from simple compositions to long shared workstations and can be integrated with Modular unit and Openwall partitions. The rectangular MEETING TABLES are available in various depths and can be composed in configurations with a shared central leg for vertical channelling. The collection is completed by a selection of accessories such as screens to increase acoustic comfort, drawer units on castors and all the technical equipment such as cable tidies and CPU holders. The collections of storage units, service furniture and accessories, all perfectly matched in terms of materials and colours, personalise the rooms.

F— DODICI est une collection de bureaux et de tables de réunion au caractère extrêmement polyvalent qui peut être utilisée dans les espaces opérationnels et manager. Elle se caractérise par une structure métallique vernie mate au design léger et essentiel, en parfaite harmonie avec les plans disponibles en mélamine, anti empreintes et verre laqué brillant en couleurs unies ou imprimées avec effet marbre, laqué, Fenix et plaqué bois. Les différentes configurations, personnalisables grâce à la grande variété de couleurs et de finitions, sont en mesure d'interpréter différents styles dans les environnements de travail et de home office. Le BUREAU MANAGER est disponible avec ou sans voile de fond dans une version simple, avec une extension ou alternativement sur une Modular unit. Les BUREAUX SECRÉTAIRE vont des compositions simples aux longs postes de travail partagés et peuvent être intégrés aux Modular unit et aux cloisons Openwall. Les TABLES DE RÉUNION rectangulaires sont disponibles en différentes profondeurs et peuvent être composées dans des configurations avec un pied central commun pour la canalisation verticale. La collection est complétée par une sélection d'accessoires tels que des écrans pour augmenter le confort acoustique, des cassoins tiroirs sur roulettes et tous les équipements technologiques tels que les passe-câbles et les port cpu. Les collections de meubles de rangement, de meubles de service et d'accessoires, toutes parfaitement assorties en termes de matériaux et de couleurs, personnalisent les pièces.

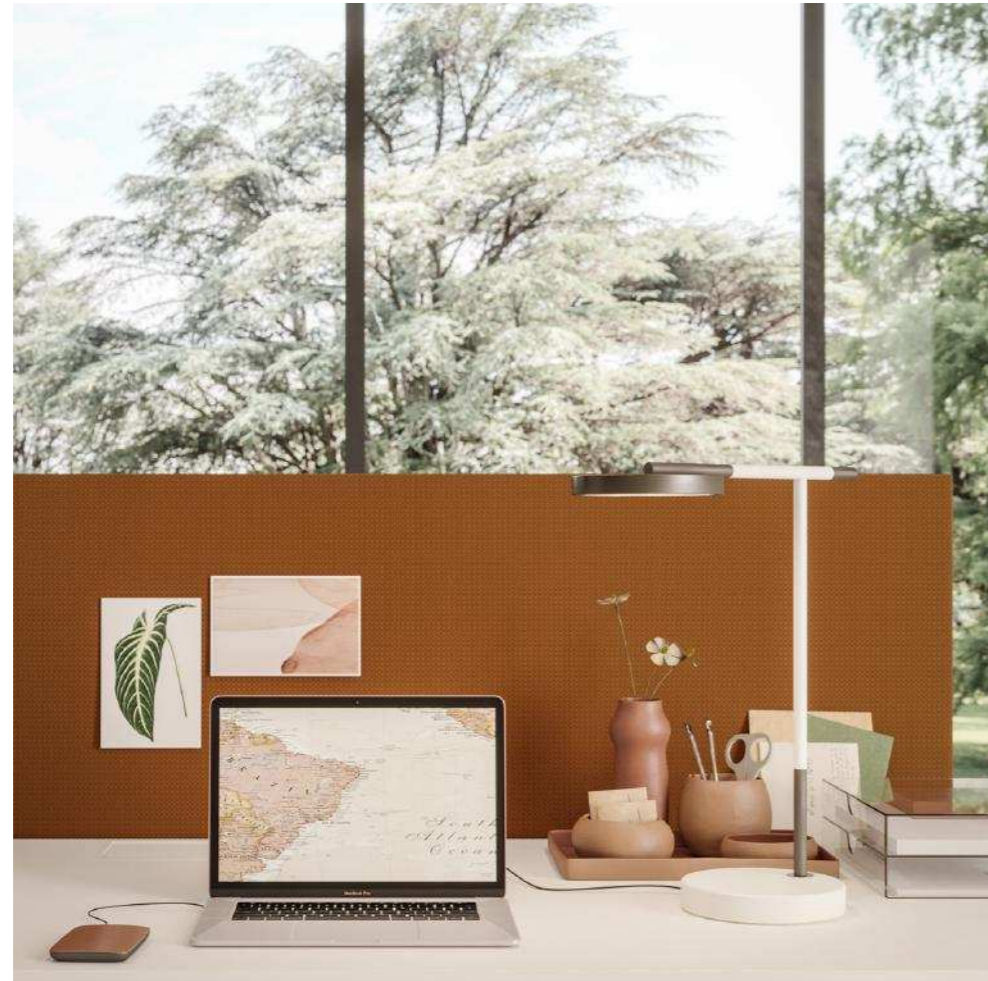

« THE CATALOGUE »

IT— Un racconto inedito che esplora la collezione DODICI attraverso un'ampia galleria di immagini ambientate, caratterizzate da armonia tra le tonalità ed eleganza degli abbinamenti. Sei progetti per ispirare e soddisfare i gusti eterogenei di un pubblico contemporaneo. Spazi operativi e manager che interpretano alcune delle molte potenzialità espressive del sistema, contraddistinto da una grande versatilità compositiva e una vasta gamma di materiali e finiture. A seguire un'accurata sezione illustrata con immagini still life, disegni tecnici e la selezione delle finiture.

EN— An unedited story exploring the DODICI collection through a wide gallery of images set, characterised by the harmony of the shades and the elegance of the combinations. Six projects to inspire and satisfy the heterogeneous tastes of a contemporary public. Operative and managerial spaces featuring some of many expressive potentials of the system, characterised by great compositional versatility and a wide range of materials and finishes. This is followed by a carefully illustrated section with still life images, technical drawings and a selection of finishes.

F— Une histoire inédite qui explore la collection DODICI à travers une vaste galerie d'images mises en scène, caractérisées par l'harmonie entre les teintes et l'élégance des combinaisons. Six projets pour inspirer et satisfaire les goûts hétérogènes d'un public contemporain. Espaces secrétaire et manager qui interprètent quelques-unes des nombreuses potentialités expressives du système, qui se distingue par une grande versatilité de composition et une large gamme de matériaux et de finitions. Elle est suivie d'une section illustrée avec précision, comprenant des images still life, des dessins techniques et une sélection de finitions.

Project 01 Working

bianco / verde oliva / terra / rovere natural
 white / olive green / ground / natural oak
 blanc / vert olive / terre / chêne naturel

IT— Ampia configurazione con scrivanie condivise a bench con piani in melaminico bianco e struttura verniciata bianca. Sono caratterizzate da screen in tessuto con una texture in rilievo color terra e verde pistacchio. Sono attrezzate con le cassettiere su ruote Easy tray in rovere natural con vassoi porta oggetti laccati terra e verde oliva e accompagnate dai set scrivania Sophie e dalle lampade da tavolo della nuova collezione Alice. Nel fondo, due contenitori della collezione Profslide in melaminico con ante scorrevoli e maniglie metalliche nei colori bianco e verde oliva con scocca interna in rovere natural.

EN— Large configuration with shared bench desks with white melamine tops and white lacquered frame. They feature fabric screens with a relief-like texture in ground and pistachio green color. They are equipped with Easy tray drawer units on castors in natural oak with lacquered ground and olive green trays and accompanied by Sophie desk sets and table lamps from the new Alice collection. In the background, two cabinets from the Profslide collection in melamine with sliding doors and metal handles in white and olive green colors with an internal shell in natural oak.

F— Grande configuration avec des bureaux à bancs partagés avec des plateaux en mélamine blanche et un cadre peint en blanc. Ils présentent des écrans en tissu avec une texture gaufrée en couleur terre et vert pistache. Ils sont équipés de caisson tiroirs sur roulettes Easy tray en chêne naturel avec des plateaux laqués terre et vert olive et accompagnés des set de bureau Sophie et des lampes de table de la nouvelle collection Alice. À l'arrière, deux deux armoires de la collection Profslide en mélamine avec des portes coulissantes et des poignées métalliques en blanc et vert olive avec une coque interne en chêne naturel.





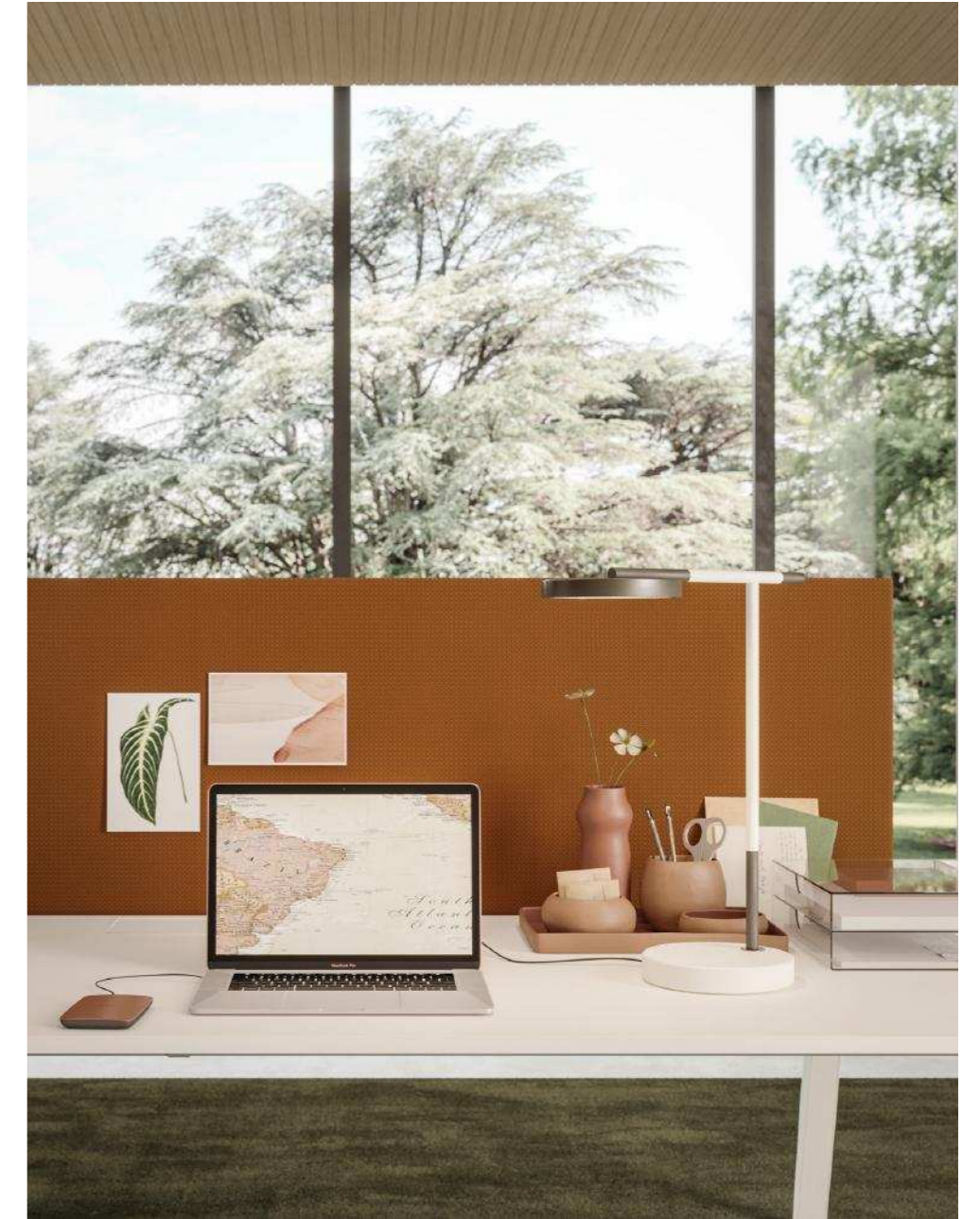





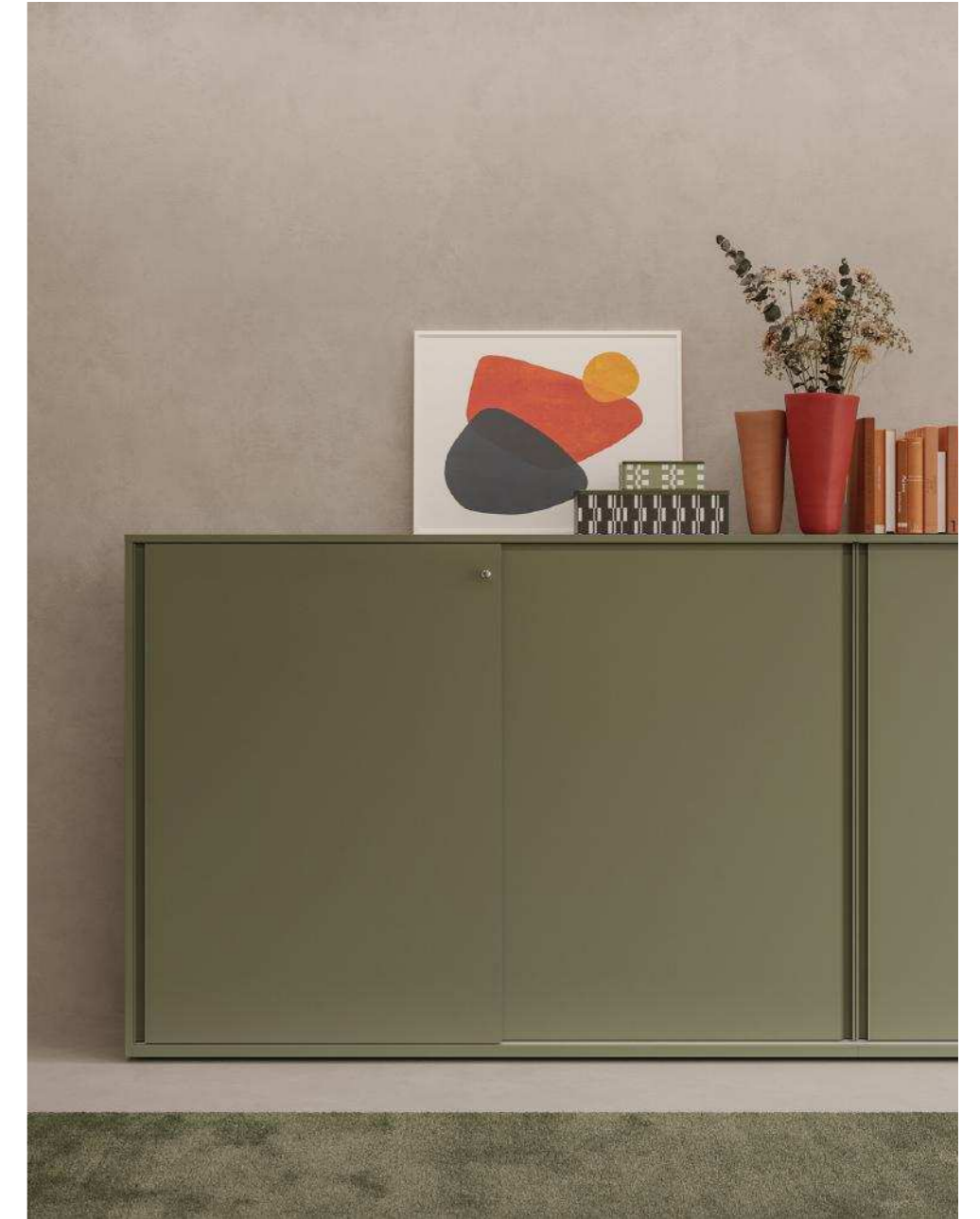



Project 02 Working

bianco / rovere natural / senape
 white / natural oak / mustard
 blanc / chêne naturel / moutarde

IT— Comode postazioni con scrivanie condivise a bench. Sono separate da screen Front fabric frontali e laterali rivestiti in tessuto di lana color senape, verde bosco e laguna. La struttura metallica è verniciata bianca e i piani sono in melaminico rovere natural. A completamento, le cassettiere su ruote Easy nei colori melaminici senape e rovere natural, i set scrivania Sophie e le lampade da tavolo Alice. Le scrivanie sono accompagnate da un mobile Profbox con fianchi e top in rovere natural, ante in melaminico bianco con maniglia metallica a gola in tinta. Ai lati, una fioriera della collezione Sessanta in melaminico rovere natural e bianco e un appendiabiti Jane bianco. Dall'altro lato, trova spazio un contenitore Profbox melaminico con ante a gola, in tinta unica color senape. A fianco, l'appendiabiti Jane in tonalità senape e la fioriera Sessanta in melaminico rovere natural e senape.

EN— Comfortable workstations with shared bench desks. They are separated by front and side screen Front fabric upholstered in mustard, forest green and lagoon wool fabric. The metal structure is white lacquered and the tops are in natural oak melamine. Completing the desks, there are Easy drawer units on castors in mustard and natural oak melamine, Sophie desk sets and Alice table lamps. The desks are accompanied by a Profbox cabinet with natural oak sides and top, white melamine doors and matching metal groove handle. At the sides, a planter from the Sessanta collection in natural oak and white melamine and a Jane white coat stand. On the other side, there is a melamine Profbox storage unit with groove handles doors in a single mustard colour. To the side, the Jane coat stand in mustard colour and the Sessanta planter in natural oak and mustard melamine.

F— Des postes de travail confortables avec des bureaux partagés au banc. Ils sont séparés par des panneaux de séparation Front fabric frontale et latérale recouverts de tissus de laine de couleur moutarde, vert forêt et lagon. La structure métallique est peinte en blanc et les plateaux sont en mélaminé chêne naturel. Les caissons à tiroirs sur roulettes Easy en mélamine moutarde et chêne naturel, les set de bureau Sophie et les lampes de table Alice complètent la gamme. Les bureaux sont accompagnés d'un meuble Profbox dont les côtés et le dessus sont en chêne naturel, les portes en mélaminé blanc avec une poignée en métal rainuré assortie. Sur les côtés, une planter de la collection Sessanta en mélaminé chêne naturel et blanc et un porte-manteau Jane blanc. De l'autre côté, il y a un conteneur Profbox avec des portes avec porte coulissantes d'une seule couleur moutarde. Sur le côté, le porte-manteau Jane de couleur moutarde et le planter Sessanta en mélaminé chêne naturel et moutarde.







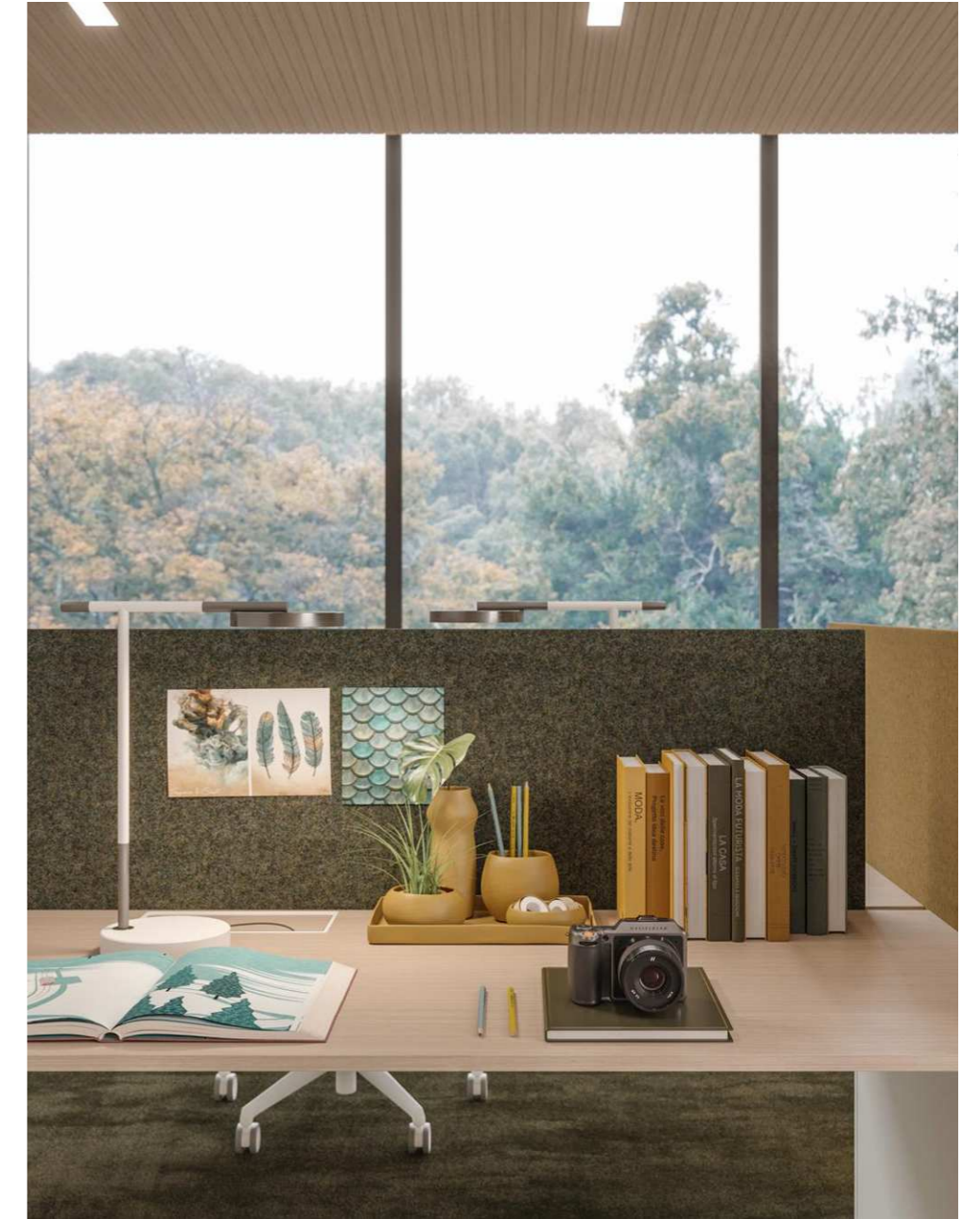





Project 03 Working

bianco / nero
white / black
blanc / noir

IT— Composizione con scrivania doppia su Modular unit, che può essere configurato liberamente scegliendo tra vani a giorno, cassetti e ante. Il piano e il contenitore sono in melaminico bianco, la gamba è verniciata nera. Come accessori, lo screen Front fabric rivestito in tessuto di lana color grigio perla; i cestini Square nelle combinazioni melaminico bianco e nero; i cuscini coordinati in tessuto di lana color grigio perla e terra; il Box porta piante per dare un tocco green alla scrivania; le lampade da tavolo della nuova collezione Alice. Versatile e funzionale, a completare un armadio Profbox in Fenix nero con ante con maniglie e moduli a giorno melaminico bianco. In versione nera, la accompagna un tavolo riunione modulare canalizzato con piano in Fenix. Nel fondo, un mobile contenitore Profbox nelle tonalità bianco e nero melaminico. A sospensione due lampadari Alice in colore nero.

EN— Composition with double desk on Modular unit, which can be freely configured by choosing between open compartments, drawers and doors. The top and the cabinet are in white melamine, the leg is black lacquered. Accessories include the Front fabric screen covered in pearl grey wool flannel; Square baskets in black and white melamine combinations; matching cushions in pearl grey and ground-toned fabric; the Plant Box to give a green touch to the desk; and table lamps from the new Alice collection. Versatile and functional, a Profbox cabinet with black Fenix doors with handles and white melamine open modules completes the collection. In the black version, it is accompanied by a channeled modular meeting table with Fenix top. In the background, a Profbox cabinet in white and black melamine. Suspended, two Alice chandeliers in black color.

F— Composition avec bureau double sur le Modular unit, qui peut être librement configurée en choisissant entre des compartiments ouverts, des tiroirs et des portes. Le plateau et le meuble de rangement sont en mélaminé blanc, le pied est peint en noir. Parmi les accessoires, citons le panneaux de séparation recouvert d'un tissu en laine gris perle; les corbeilles Square en mélamine combinée noire et blanche; les coussins coordonnés en tissu gris perle et couleur terre; la Box à plantes pour donner une touche verte au bureau; les lampes de table de la nouvelle collection Alice. Polyvalente et fonctionnelle, une armoire Profbox en Fenix noir avec portes à poignées et modules ouverts en mélamine blanche complète la collection. Dans la version noire, il est accompagné d'une table de réunion modulaire canalisée avec plateau Fenix. En arrière-plan, un meuble de rangement Profbox en mélaminé blanc et noir. Deux lampes suspendues Alice en noir.













Project 04 working

rosso oriente / rovere natural
orient red / natural oak
rouge orient / chêne naturel

IT— Configurazione con doppie postazioni condivise in unico colore rosso oriente, separate dagli screen arrotondati Soft in tessuto con texture in rilievo color rosso oriente e prugna. Come complementi, cassettiere su ruote Easy in melaminico rosso oriente, cestini Square in melaminico rovere natural e rosso oriente e lampade da tavolo Alice laccate rosso oriente. Nelle tonalità coordinate, trovano spazio un mobile Profbox in rovere natural con maniglie e vani a giorni color rosso oriente e un appendiabiti Jane.

Abbinata un'area break con tavoli alti della collezione Table con piano dal bordo smussato in melaminico rovere natural e struttura metallica rosso oriente. Nel fondo un contenitore Profbox in versione melaminico rosso oriente con ante push to open e moduli a giorno.

EN— Configuration with two shared workstations in a single orient red colour, separated by two rounded Soft screens in fabric with relief-like textures in orient red and plum. Complementary items include Easy pedestal drawer units on castors in orient red melamine, Square baskets in natural oak and orient red melamine and orient red lacquered Alice table lamps. In matching colours, there is a Profbox cabinet in natural oak with handles and open compartments in orient red and a Jane coat stand.

There is also a break area with high tables from the Table collection with a bevelled edge top in natural oak melamine and an orient red metal frame. In the background a Profbox storage in orient red melamine with push to open doors and open modules.

F— Configuration avec deux postes de travail partagés dans une seule couleur rouge orient, séparés par deux écrans Soft arrondis en tissu avec des textures en relief rouge orient et prune. Parmi les accessoires, les caissons tiroirs sur roulettes Easy en mélamine rouge orient, les corbeilles Square en chêne naturel et en mélamine rouge orient et les lampes de table Alice en laque rouge orient. Dans des couleurs assorties, il y a un meuble Profbox en chêne naturel avec des poignées et des compartiments ouverts en rouge orient et un portemanteau Jane.

Il y a également une zone de break avec des tables hautes de la collection Table avec un plateau à bord biseauté en mélamine de chêne naturel et une structure métallique rouge orient. À l'arrière, un meuble de rangement Profbox en mélaminé rouge orient avec des portes avec mécanisme push to open et des modules ouverts.





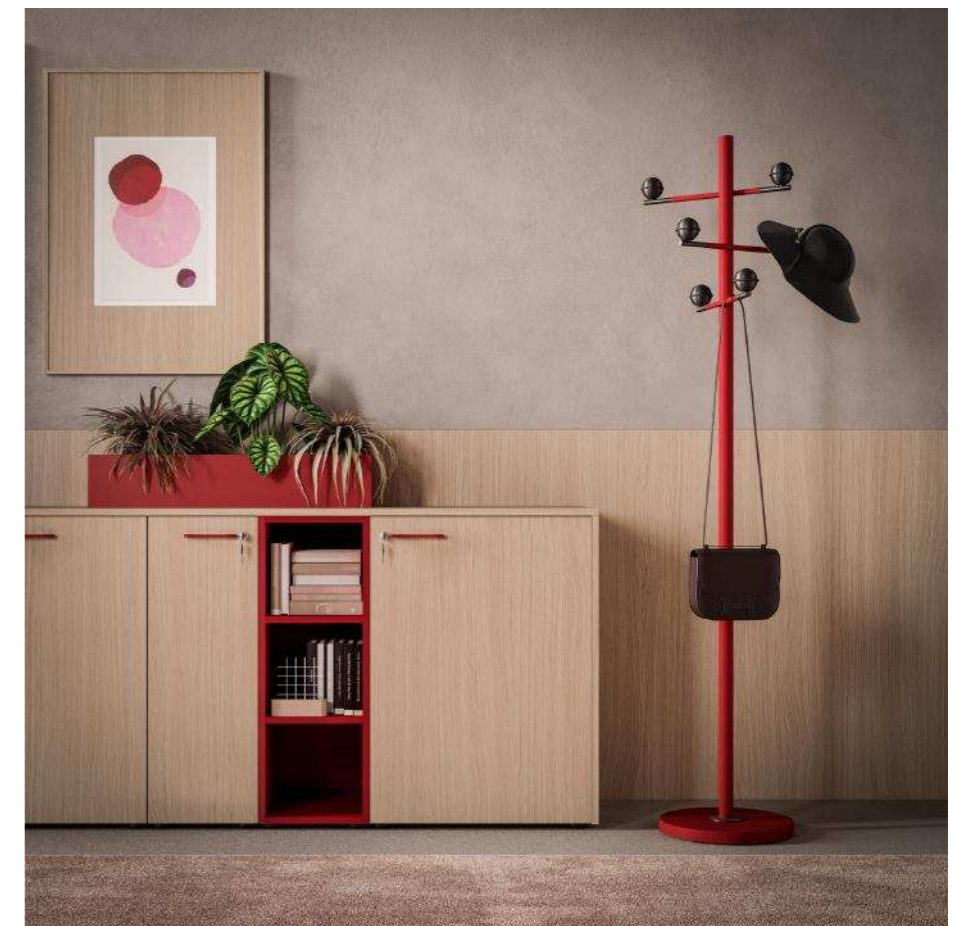







Project 05 Manager

beige / noce natural
 beige / natural walnut
 beige / noyer naturelle

IT— La scrivania in versione manager è proposta con piano in melaminico noce natural e struttura beige ed è abbinata al mobile portante Modular unit in melaminico beige con vani a giorno, ante e cassetti push to open. Per personalizzare lo spazio di lavoro si possono scegliere i numerosi accessori e complementi a catalogo come il set scrivania Sophie e la lampada da tavolo Alice qui presenti. Nel fondo, due contenitori Profbox in tonalità melaminico beige, con maniglie metalliche in tinta. Il tavolo riunioni abbinato è modulare e canalizzato con gamba centrale condivisa. Il piano è in finitura melaminico noce natural e la struttura è in colore beige. Dietro, trova spazio un mobile contenitore Profbox in melaminico giocato nelle medesime tonalità con ante push to open e vani a giorno. L'area attesa è arredata con tavoli quadrati nella collezione Table con struttura metallica beige e piani in melaminico beige e rovere natural. A fianco, lampada da terra Alice e appendiabito Jane in colore rosso oriente.

EN— The manager version of the desk has a walnut melamine top and beige structure and is combined with the Modular unit beige melamine with open compartments, doors and push-to-open drawers. To personalise the work space you can choose from the numerous accessories and complements in the catalogue such as the Sophie desk set and Alice table lamp shown here. At the bottom, two Profbox storage units in beige melamine with matching metal handles. The matching meeting table is modular and channelled with a shared central leg. The top has natural walnut melamine finish and the structure is beige. Behind there is a Profbox storage in melamine with push-to-open doors and open compartments in the same colour. The waiting area is furnished with square tables from the Table collection with a beige metal structure and tops in beige melamine and natural oak. On the side, Alice floor lamp and Jane clothes stand in orient red.

F— La version manager du bureau a un plateau en mélaminé noyer naturelle et une structure beige et est combinée avec le Modular unit en mélaminé beige avec des compartiments ouverts, des portes et des tiroirs push-to-open. Pour personnaliser l'espace de travail, vous pouvez choisir parmi les nombreux accessoires et compléments du catalogue, comme le set de bureau Sophie et la lampe de table Alice présentés ici. Dans le fond, deux rangements Profbox en mélaminé beige, avec poignées métalliques assorties. La table de réunion assortie est modulaire et canalisée avec un pied central commun. Le plan est en mélaminé noyer naturelle et la structure est de couleur beige. Derrière, on trouve un meuble de rangement Profbox en mélamine dans les mêmes tons, avec des portes à ouverture par poussée et des compartiments ouverts. La zone d'attente est meublée de tables carrées de la collection Table avec une structure en métal beige et des plateaux en mélamine beige et en chêne naturelle. Sur le côté, le lampe du sol Alice et le portemanteau Jane en rouge orient.









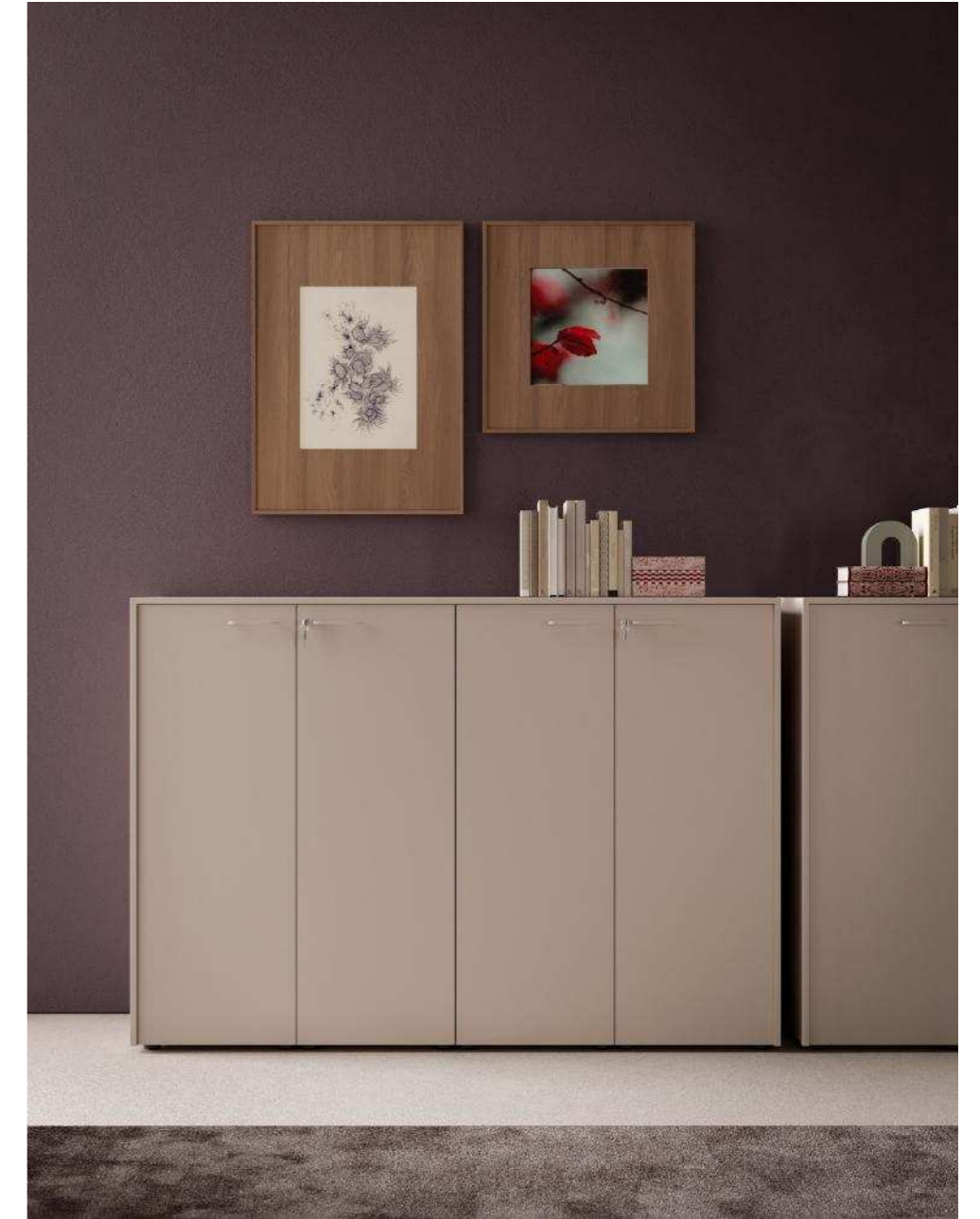



Project 06 Manager

nero / nero Marquina / terra
 black / black Marquina / ground
 noir / noir Marquina / terre

IT— La scrivania manager con dattilo è presentata con piano in vetro stampato anti touch nero Marquina, gonna in Fenix nero e struttura verniciata nera. Caratterizzano lo spazio di lavoro il sottomano Skin in color cuoio, il set scrivania Sophie, la lampada da tavolo Alice in color terra, il gettacarte Louise con struttura metallica nera e vetro stampato anti touch nero Marquina. Nel fondo, due contenitori Profbox in Fenix nero con vani a giorno e ante a sandwich in vetro stampato anti touch nero Marquina con profilo metallico e maniglia integrata color nero. Il tavolo riunioni modulare canalizzato con gamba centrale condivisa ha il piano in vetro stampato anti touch nero Marquina e la struttura metallica verniciata nera. I contenitori Profbox hanno top, fianchi e ante laccate in color terra e vani a giorno nero melaminico. Accanto due fioriere da interno della collezione Louise con struttura metallica nera e vetro stampato anti touch nero Marquina. Sopra il tavolo scendono due lampadari Alice in colore nero.

EN— The manager desk with extension is presented with a black Marquina anti touch printed glass top, black Fenix modesty panel and black varnished frame. The workspace is characterised by the Skin leather-coloured underhand, the Sophie desk set, the Alice table lamp in ground colour, the Louise wastepaper with black metal structure and black Marquina anti touch printed glass. In the back, two black Fenix Profbox containers with open compartments and sandwich doors in black Marquina anti touch printed glass with a black metal frame and integrated handle. The channelled modular meeting table with shared central leg has a black Marquina anti touch printed glass top and black painted metal structure. The Profbox storage units have lacquered tops, sides and doors in the ground colour and black melamine open compartments. Next to them are two indoor planters from the Louise collection with a black metal structure and black Marquina anti touch printed glass. Above the table there are two Alice chandeliers in black.

F— Le bureau manager avec retour est présenté avec un plateau en verre imprimé anti empreintes noir Marquina, une voile defond Fenix noire et une structure peinte en noir. L'espace de travail est caractérisé par le sous main Skin couleur cuir, le set de bureau Sophie, la lampe de table Alice couleur terre, la corbeille Louise avec structure en métal noir et le verre imprimé anti empreintes noir Marquina. A l'arrière, deux meubles de rangement Profbox en Fenix noir avec des compartiments ouverts et des portes sandwich en verre imprimé anti empreintes noir Marquina avec profil métallique et poignée noire intégrée. La table de réunion modulaire canalisée avec pied central commun a un plateau en verre imprimé anti empreintes noir Marquina et une structure en métal peint en noir. Les meubles de rangement Profbox ont des dessus, des côtés et des portes laqués en couleur terre et des compartiments ouverts en mélamine noire. À côté d'eux, deux planters d'intérieur de la collection Louise avec une structure en métal noir et en verre imprimé anti empreintes noir Marquina. Au-dessus de la table se trouvent deux chandeliers Alice de couleur noire.

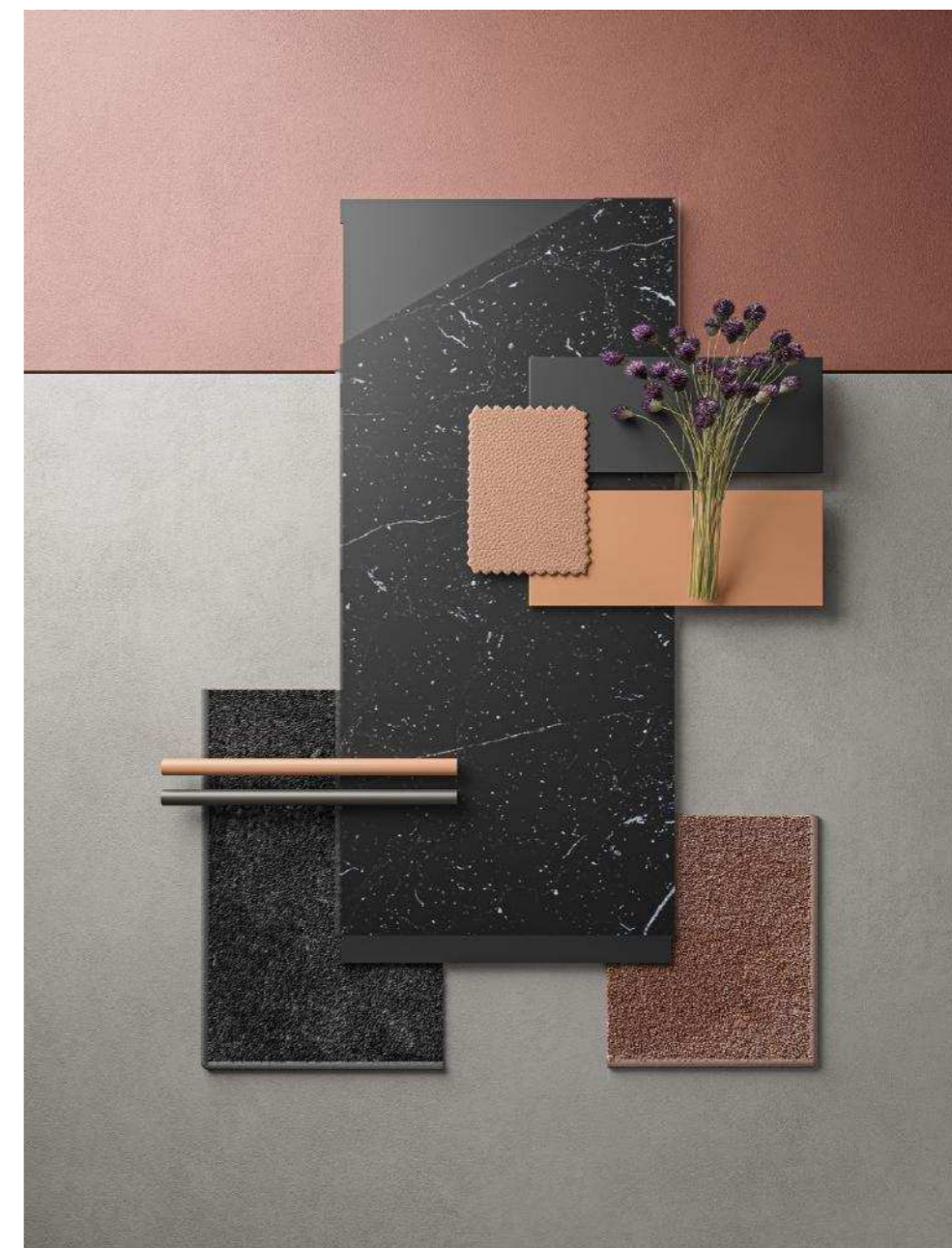

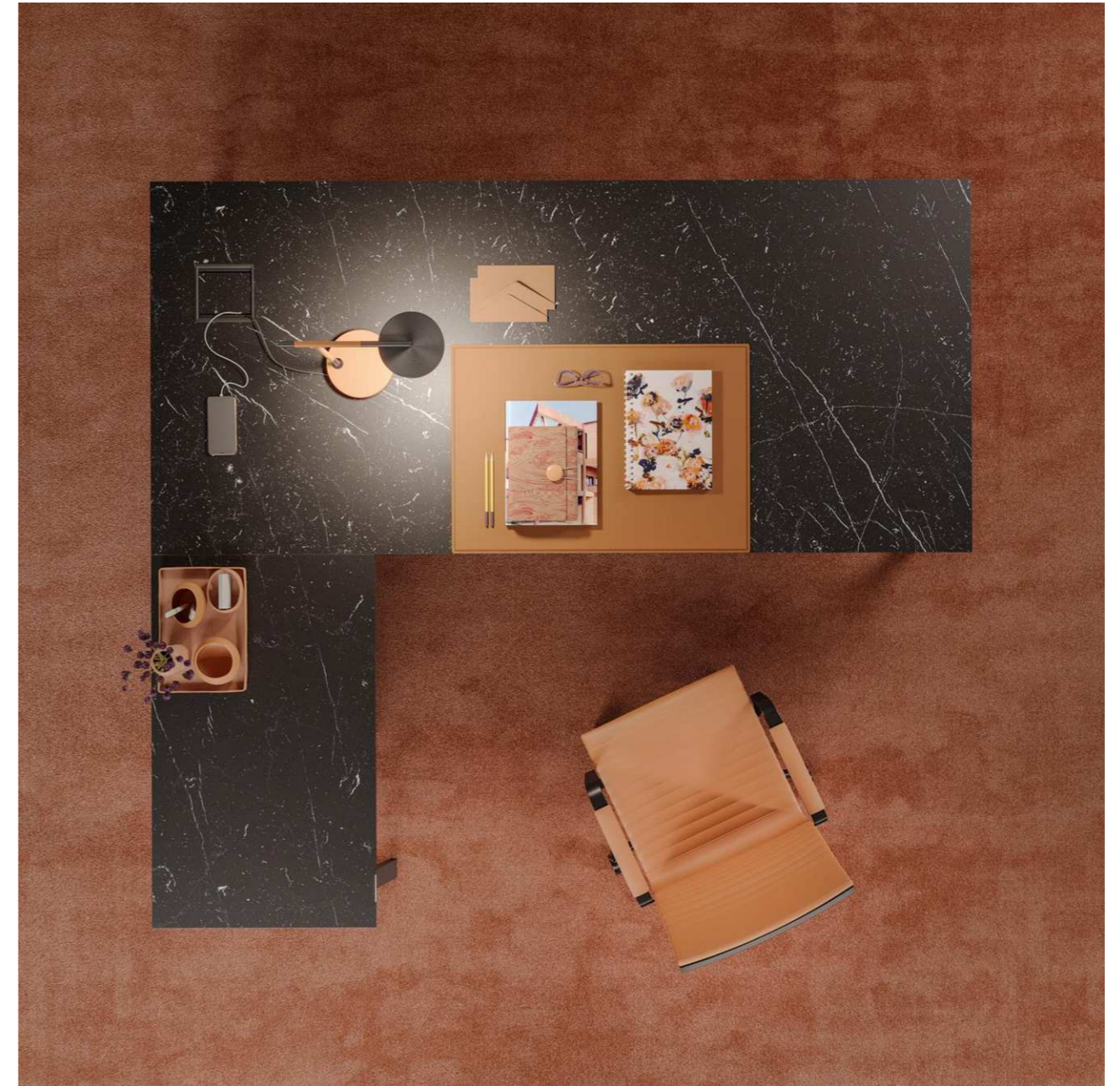











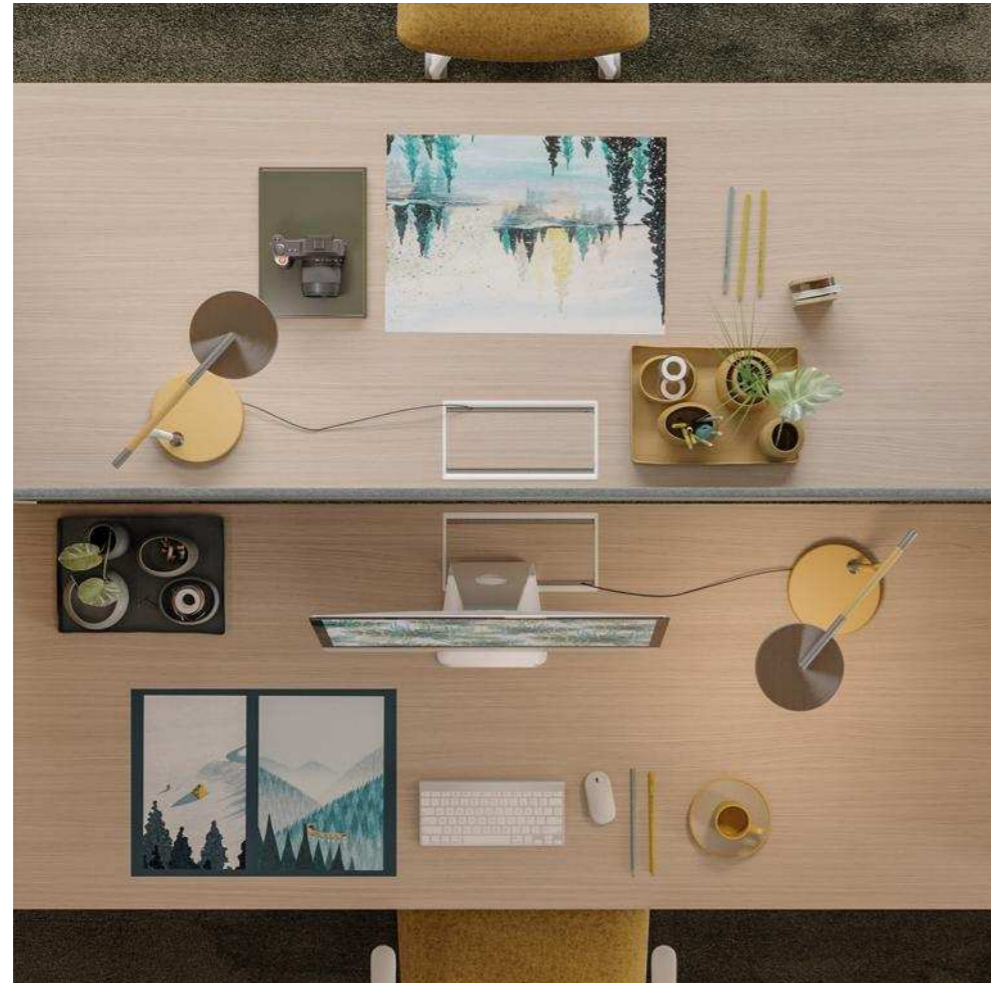

« TECHNICALS »

IM - IMPIALLACCIATO LEGNO / WOOD VENEER / PLAQUÉ BOIS



V71M
rovere natural
natural oak
chêne naturel

V44M
noce Canaletto
walnut Canaletto
noyer Canaletto

V50M
rovere termotrattato
thermotreated oak
chêne traité thermiquement

V48M
ebano Makassar
ebony Makassar
ébène Makassar

FX - FENIX NTM® / FENIX NTM® / FENIX NTM®

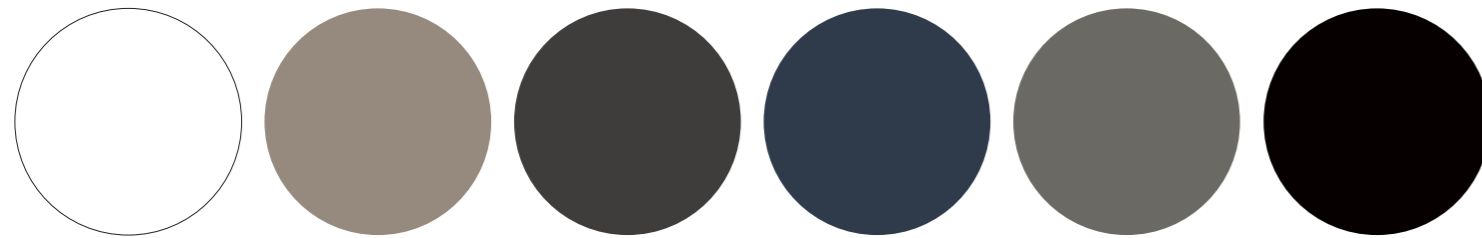

F032
bianco
white
blanc

F717
castoro
beaver
castor

F749
cacao
cocoa
cacao

F754
blu scuro
dark blue
bleu foncé

F718
grigio Londra
London grey
gris Londres

F720
nero
black
noir

ME - MELAMINICO / MELAMINE / MÉLAMINÉ



M71W
rovere natural
natural oak
chêne naturel

M75W
noce natural
natural walnut
noyer naturelle

M77W
noce dark
dark walnut
noyer foncé

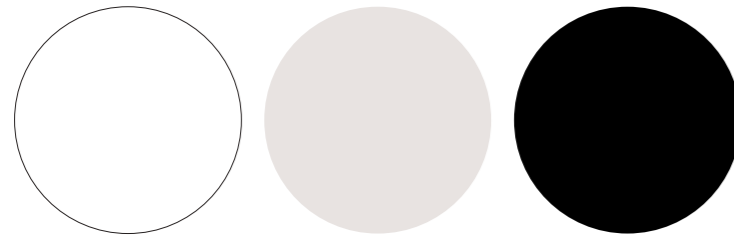

M200
bianco
white
blanc

M010
grigio chiaro
light grey
gris clair

M040
nero
black
noir

MC - COLORE MELAMINICO / MELAMINE COLOR / COULEUR MÉLAMINÉE

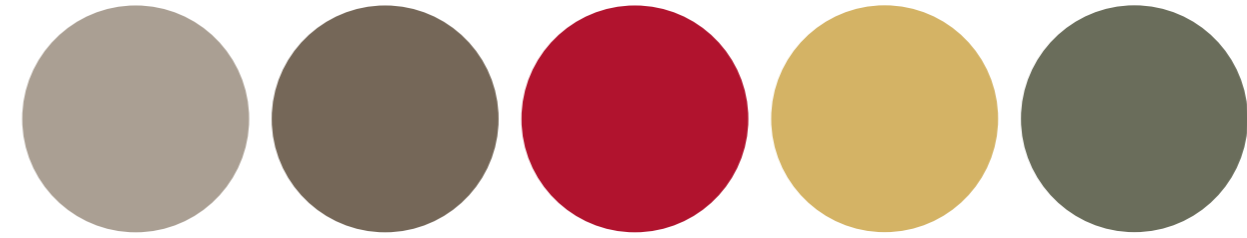

C260
beige
beige
beige

C250
tabacco
tobacco
tabac

C290
rosso oriente
orient red
rouge orient

C390
senape
mustard
moutarde

C240
verde oliva
olive green
vert olive

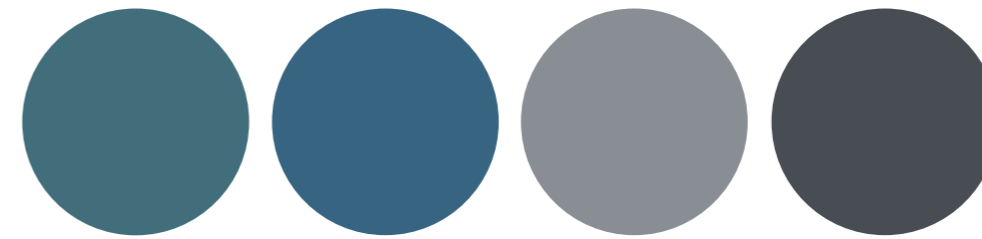

C330
petrolio
petroleum
pétrole

C350
blue sea
blue sea
bleue mer

C340
grigio perla
pearl grey
gris perle

C300
basalto
basalt
basalte

SB - VETRO STAMPATO BRILLANTE / BRILLIANT PRINTED GLASS / VERRE IMPRIMÉ BRILLANT

SA - VETRO STAMPATO ANTI TOUCH / ANTI TOUCH PRINTED GLASS / VERRE IMPRIMÉ ANTI EMPREINTES



P0770B
P0770A
Calacatta oro
Calacatta gold
Calacatta or

P2069B
P2069A
Emperador dark
Emperador dark
Emperador dark

P1944B
P1944A
stone grey
stone grey
stone grey

P1377B
P1377A
nero Marquina
black Marquina
noir Marquina

OS - ALLUMINIO OSSIDATO / OXIDIZED ALUMINIUM / ALUMINIUM OXYDÉ



OB7S
ottone spazzolato
brushed brass
laiton brossé

OASC
alluminio spazzolato
brushed aluminum
aluminium brossé

OE8S
nero spazzolato
brushed black
noir brossé

VB - VETRO LACCATO BRILLANTE / BRILLIANT LACQUERED GLASS / VERRE LAQUÉ BRILLANT
VA - VETRO LACCATO ANTI TOUCH / ANTI TOUCH LACQUERED GLASS / VERRE LAQUÉ ANTI EMPREINTES

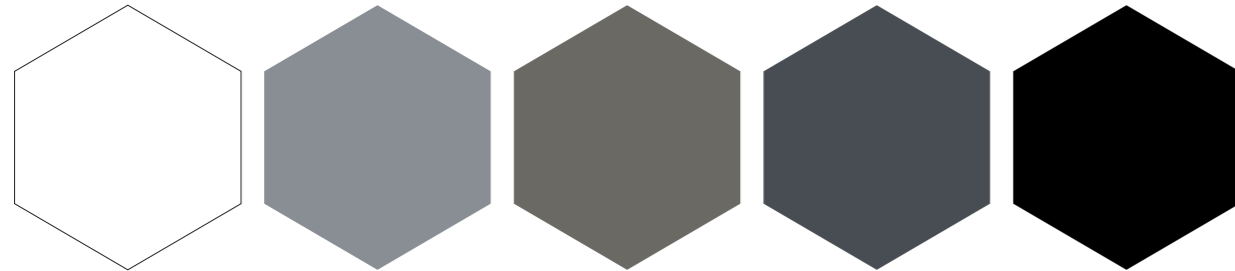

Q9010B Q9010A bianco white blanc	Q7045B Q7045A grigio perla pearl grey gris perle	Q7030B Q7030A grigio Londra London grey gris Londres	Q7500B Q7500A basalto basalt basalte	Q9005B Q9005A nero black noir
--	--	--	--	---

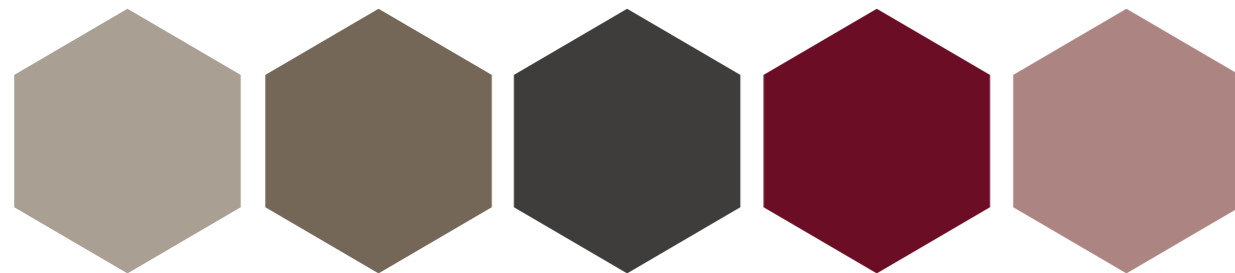

Q3047B Q3047A beige beige beige	Q6005B Q6005A tabacco tobacco tabac	Q8019B Q8019A cacao cocoa cacao	Q3004B Q3004A rosso rubino ruby red rouge rubis	Q4020B Q4020A desert rose desert rose desert rose
---	---	---	---	---

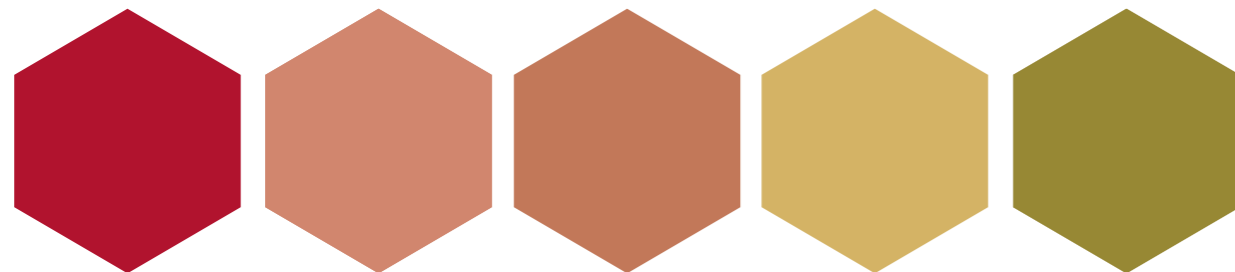

Q3031B Q3031A rosso oriente orient red rouge orient	Q3012B Q3012A rame copper cuivre	Q3040B Q3040A terra ground terre	Q0039B Q0039A senape mustard moutarde	Q4050B Q4050A verde pistacchio pistachio green vert pistache
---	--	--	---	--



Q7003B Q7003A verde oliva olive green vert olive	Q7010B Q7010A verde bosco forest green vert forêt	Q0033B Q0033A petrolio petroleum pétrole	Q6020B Q6020A blue sea blue sea bleue mer	Q5011B Q5011A blu scuro dark blue bleu foncé
--	---	--	---	--

MO - METALLO VERNICIATO OPACO / MATT VARNISHED METAL / MÉTAL VERNI MAT



E90100 bianco white blanc	E70470 grigio chiaro light grey gris clair	E70450 grigio perla pearl grey gris perle	E7030M grigio Londra London grey gris Londres	E7500M basalto basalt basalte	E90050 nero black noir
---	--	---	---	---	--



E3047M beige beige beige	E70480 castoro beaver castor	E80190 cacao cocoa cacao	E10360 ottone brass laiton
--	--	--	--

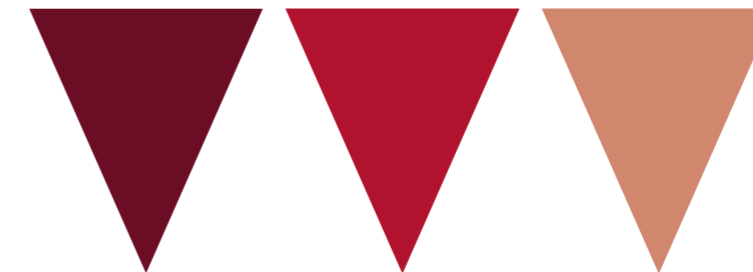

E30040 rosso rubino ruby red rouge rubis	E30310 rosso oriente orient red rouge orient	E30120 rame copper cuivre
--	--	---



E70030 verde oliva olive green vert olive	E0033M petrolio petroleum pétrole	E50110 blu scuro dark blue bleu foncé
---	---	---

LA - LACCATO OPACO PLUS
MATT LACQUERED PLUS
LAQUÉ MAT PLUS

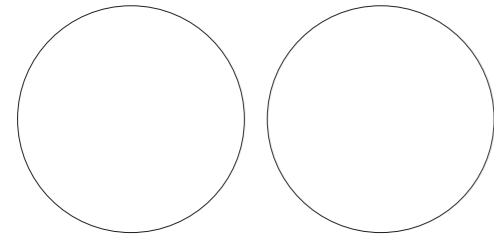

D9016M
 bianco neve
 snow white
 blanche neige

D9010M
 bianco
 white
 blanc

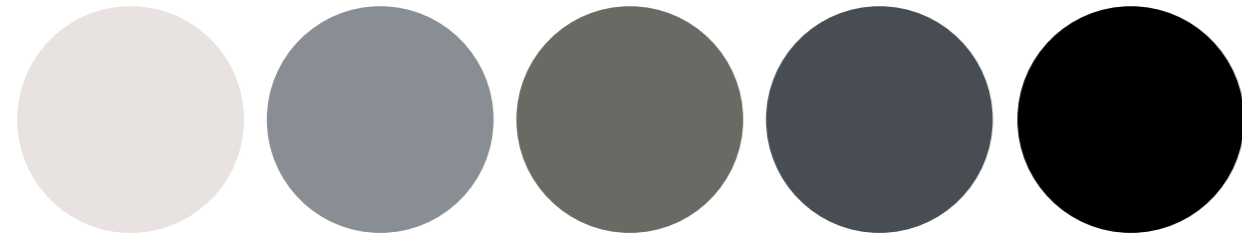

D1500M
 grigio chiaro
 light grey
 gris clair

D4500M
 grigio perla
 pearl grey
 gris perle

D7030M
 grigio Londra
 London grey
 gris Londres

D7500M
 basalto
 basalt
 basalte

D9005M
 nero
 black
 noir

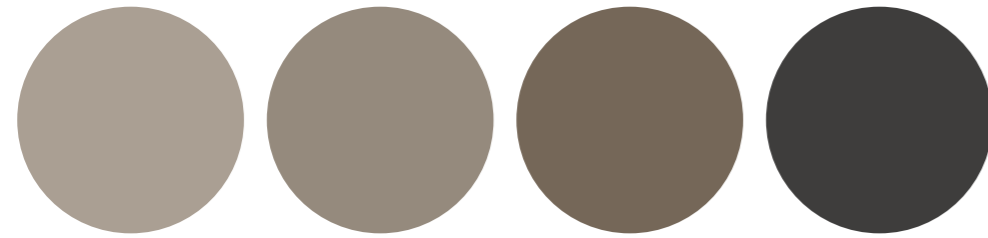

D3005M
 beige
 beige
 beige

D7048M
 castoro
 beaver
 castor

D6005M
 tabacco
 tobacco
 tabac

D7502M
 cacao
 cocoa
 cacao

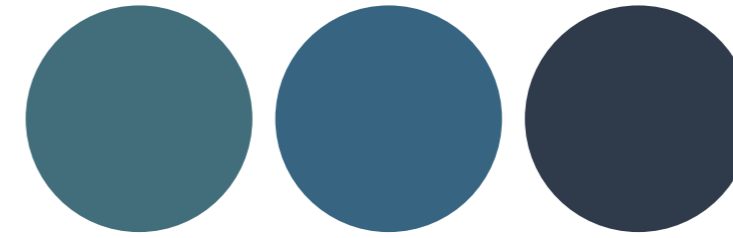

D5020M
 petrolio
 petroleum
 huile

D6020M
 blue sea
 blue sea
 mer bleue

D5011M
 blu scuro
 dark blue
 bleu foncé

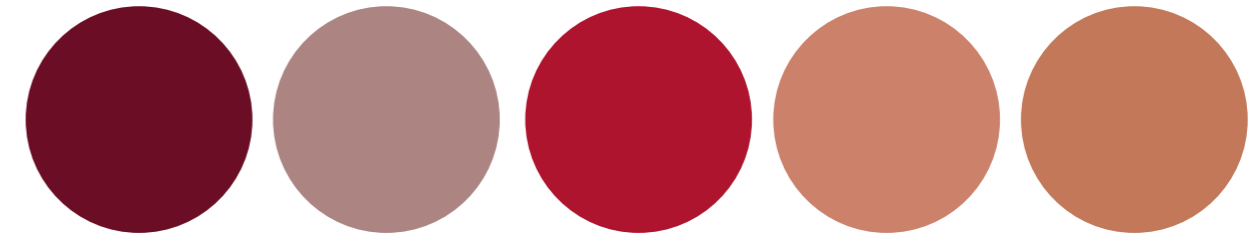

D3004M
 rosso rubino
 ruby red
 rouge rubis

D4020M
 desert rose
 desert rose
 desert rose

D2070M
 rosso oriente
 orient red
 rouge orient

D3012M
 rame
 copper
 cuivre

D3040M
 terra
 ground
 terre

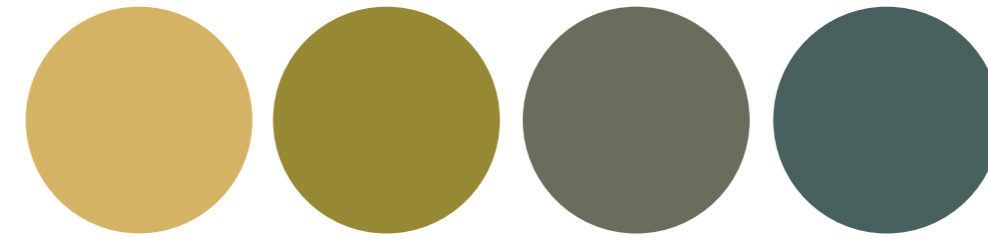

D0039M
 senape
 mustard
 moutarde

D4050M
 verde pistacchio
 pistachio green
 vert pistache

D6010M
 verde oliva
 olive green
 vert olive

D7010M
 verde bosco
 forest green
 vert forêt

TS1 - TESSUTO MIRAGE / MIRAGE FABRIC / TISSU MIRAGE



TS3 - TESSUTO FENICE / FENICE FABRIC / TISSU FENICE



TS4 - TESSUTO SNOB / SNOB FABRIC / TISSU SNOB



TS7 - TESSUTO RONDO / RONDO FABRIC / TISSU RONDO

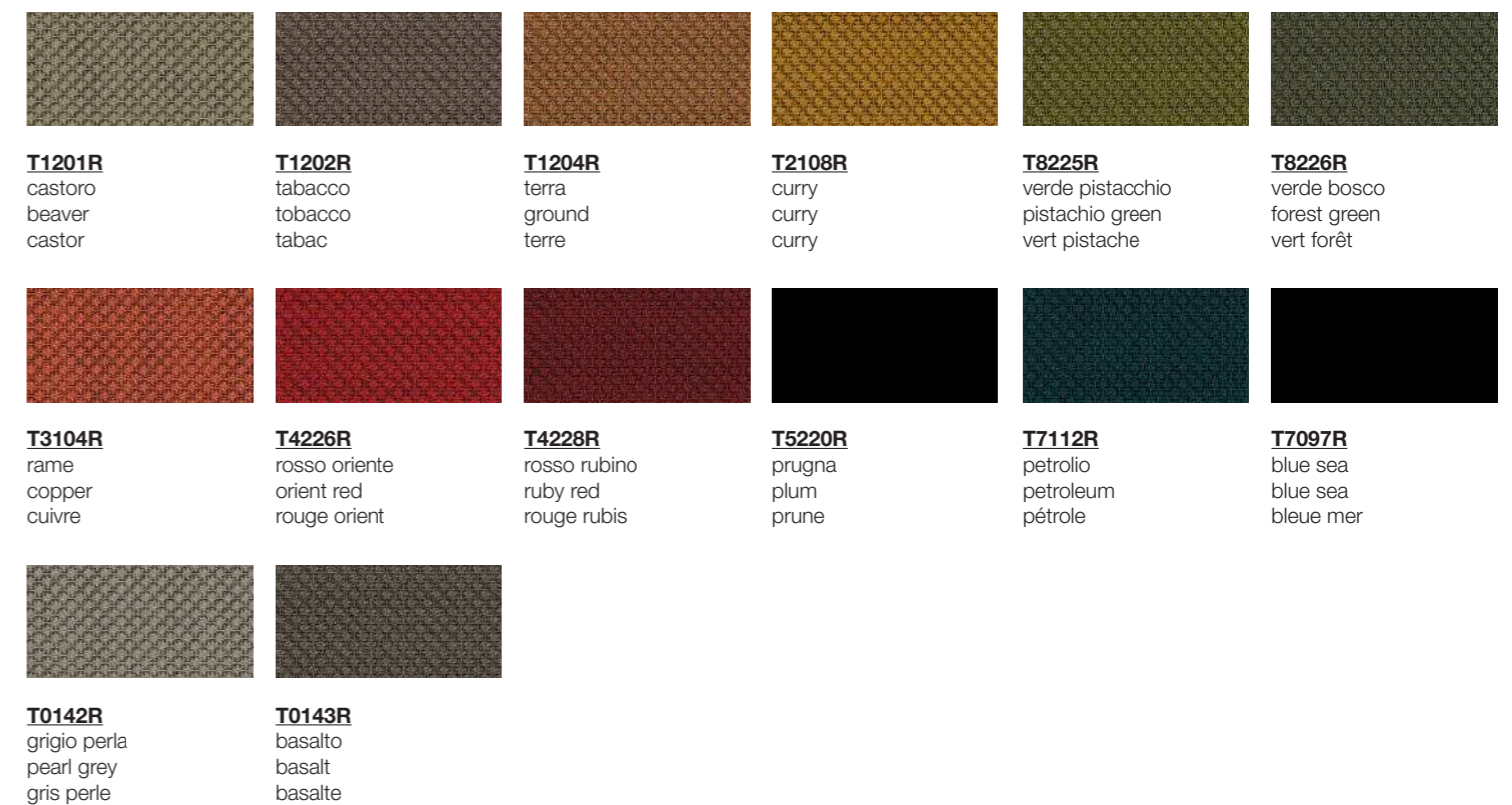

SCRIVANIA MANAGER
MANAGER DESK
BUREAU MANAGER

IT— La scrivania ha una struttura metallica verniciata opaca nelle numerose tonalità a catalogo. Il piano e la gonnella possono essere in legno melaminico, laccato, Fenix e impiallacciato con spessore di 18/19 mm. È anche previsto in vetro laccato anti touch e brillante o stampato effetto marmo anti touch e brillante. Il piano in vetro ha spessore totale 18 mm con lastre di 4 mm su supporto melaminico bianco o nero sp.14 mm con bordo in tinta con il piano. La scrivania può essere canalizzata su richiesta.

EN— The desk has a matt varnished metal frame in the numerous catalogue colours. The top and the modesty panel can be in melamine wood, lacquered, Fenix and wood veneer with a thickness of 18/19 mm. It is also available in anti-touch and brilliant lacquered glass or printed with anti-touch and brilliant marble effect. The glass top has a total thickness of 18 mm with sheets of 4 mm on a white or black melamine support 14 mm thick with edge matching the top. The desk can be ducted on request.

F— Le bureau a une structure métallique vernie mate dans les nombreuses teintes du catalogue. Le plateau et le voile de fond peuvent être en bois de mélamine, en laqué et en placage d'une épaisseur de 18/19 mm. Il est également disponible en verre laqué anti empreintes et brillant ou imprimé avec un effet marbre anti empreintes et brillant. Le plateau en verre a une épaisseur totale de 18 mm avec des feuilles de 4 mm sur un support en mélamine blanche ou noire de 14 mm d'épaisseur avec un bord assorti au plateau. Le bureau peut être canalisé sur demande.

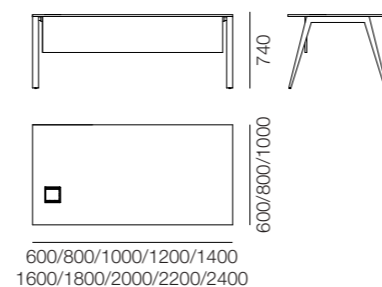

SCRIVANIA MANAGER + DATTOLO
MANAGER DESK + EXTENSION
BUREAU MANAGER + RETOUR

IT— La scrivania ha una struttura metallica verniciata opaca nelle numerose tonalità a catalogo. Il piano e la gonnella possono essere in legno melaminico, laccato, Fenix e impiallacciato con spessore di 18/19 mm. È anche previsto in vetro laccato anti touch e brillante o stampato effetto marmo anti touch e brillante. Il piano in vetro ha spessore totale 18 mm con lastre di 4 mm su supporto melaminico bianco o nero sp.14 mm con bordo in tinta con il piano. La scrivania può essere canalizzata su richiesta. Il dattilo funge da comoda estensione del piano di lavoro.

EN— The desk has a matt varnished metal frame in the numerous catalogue colours. The top and the modesty panel can be in melamine wood, lacquered, Fenix and wood veneer with a thickness of 18/19 mm. It is also available in anti-touch and brilliant lacquered glass or printed with anti-touch and brilliant marble effect. The glass top has a total thickness of 18 mm with sheets of 4 mm on a white or black melamine support 14 mm thick with edge matching the top. The desk can be ducted on request. The extension acts as a convenient extension of the worktop.

F— Le bureau a une structure métallique vernie mate dans les nombreuses teintes du catalogue. Le plateau et le voile de fond peuvent être en bois de mélamine, en laqué et en placage d'une épaisseur de 18/19 mm. Il est également disponible en verre laqué anti empreintes et brillant ou imprimé avec un effet marbre anti empreintes et brillant. Le plateau en verre a une épaisseur totale de 18 mm avec des feuilles de 4 mm sur un support en mélamine blanche ou noire de 14 mm d'épaisseur avec un bord assorti au plateau. Le bureau peut être canalisé sur demande. Le retour agit comme une extension pratique du plan de travail.

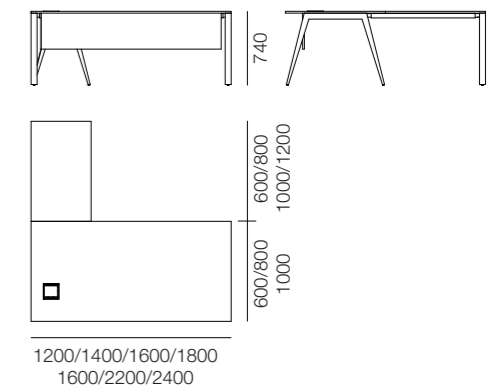

SCRIVANIA MANAGER + MODULAR UNIT
 MANAGER DESK + MODULAR UNIT
 BUREAU MANAGER + MODULAR UNIT

IT— La scrivania manager può essere integrata al contenitore Modular unit, composto da elementi modulari liberamente accostabili tra loro in profondità 600 mm e in due larghezze 416 mm e 832 mm. Si possono scegliere vani a giorno, tra cui il porta CPU canalizzato e vani chiusi da ante o cassetti, dotati di serratura con maniglie o push to open. È disponibile anche il modulo con vani a giorno di testa iniziale o finale.

EN— The manager desk can be combined with the Modular unit, composed of modular elements freely approachable together at a depth of 600 mm and in two widths 416 mm and 832 mm. There is a choice of open compartments, including a ducted CPU holder, and compartments closed by doors or drawers, fitted with a lock with handles or push-to-open. Also available is the module with open top or end compartments

F— Le bureau manager peut être combiné avec le conteneur Modular unit, composé d'éléments modulaires qui peuvent être librement combinés en 600 mm de profondeur et en deux largeurs, 416 mm et 832 mm. Il est possible de choisir des compartiments ouverts, y compris le support de l'unité centrale canalisée, et des compartiments fermés par des portes ou des tiroirs, équipés de poignées de verrouillage ou d'un système d'ouverture par pression. Le module est également disponible avec des compartiments ouverts à l'avant ou à l'arrière.

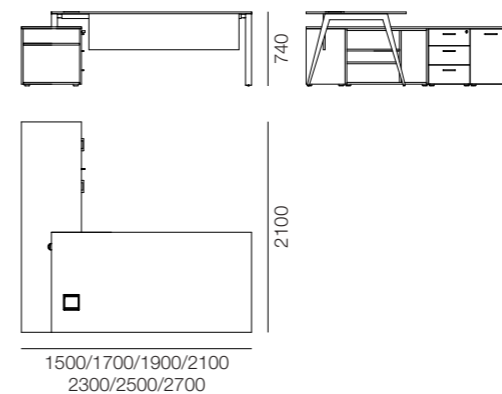

SCRIVANIA OPERATIVA + MODULAR UNIT
 WORKING DESK + MODULAR UNIT
 BUREAU SECRÉTAIRE + MODULAR UNIT

IT— Le postazioni operative si abbinano facilmente al contenitore portante Modular unit, che funge da comodo archivio e piano di appoggio per accessori come il box porta piante in legno o il cuscino. Il mobile è composto da elementi modulari liberamente accostabili tra loro in profondità 600 mm e in due larghezze 416 mm e 832 mm. Si possono scegliere vani a giorno, tra cui il porta CPU canalizzato e vani chiusi da ante o cassetti, dotati di serratura con maniglie o push to open. È disponibile anche il modulo con vani a giorno di testa iniziale o finale e il modulo Bridge in varie lunghezze, che è una panca attrezzabile con passacavi, caricatore wireless, vasca metallica porta piante ad incasso e cuscino.

EN— The workstations can easily be combined with the Modular unit, which serves as a convenient storage and comfortable working top for accessories such as the wooden plant box or cushion. The furniture is composed of modular elements freely accessible together at a depth of 600 mm and in two widths 416 mm and 832 mm. There is a choice of open compartments, including a ducted CPU holder, and compartments closed by doors or drawers, fitted with a lock with handles or push-to-open.

Also available is the module with open top or end compartments and the Bridge module in various lengths, which is a bench that can be equipped with a cable tidies, wireless charger, built-in metal tank and cushion.

F— Les bureaux secrétaire peuvent facilement être combinés avec le Modular unit, qui sert de surface de rangement et de support pratique pour les accessoires tels que le bac à plantes en bois ou le coussin. L'armoire se compose d'éléments modulaires librement accessibles entre eux à une profondeur de 600 mm et en deux largeurs de 416 mm et 832 mm. Vous pouvez choisir entre des compartiments ouverts, y compris le support du processeur cannelé, et des compartiments fermés par des portes ou des tiroirs avec poignée ou bouton poussoir pour ouvrir. Il est également disponible le module avec des compartiments ouverts au début ou à la fin et le module Bridge en différentes longueurs, qui est un banc qui peut être équipé d'un chemin de câbles, d'un chargeur sans fil, d'un bac à plantes encastré en métal et d'un coussin.



SCRIVANIA BENCH
BENCH DESK
BENCH BUREAU

IT— Configurazione con scrivanie condivise attrezzate con pannelli divisorii per garantire comfort acustico, privacy e giusta separazione.

EN— Configuration with shared desks equipped with front and side screens to guarantee acoustic comfort, privacy and right separation.

F— Le configuration avec bureaux partagés sont équipées de panneaux de séparation pour garantir le confort acoustique, l'intimité et une séparation adéquate.





SCREEN / FRONT
SCREEN / FRONT
ÉCRAN / FRONT

IT— Pannelli divisori da scrivania per dividere le postazioni favorendo concentrazione e privacy. Semplici e lineari, da fissare alla scrivania, sono in legno melaminico o laccato nelle numerose tonalità a catalogo. Disponibili in varie lunghezze, sono alti 454 mm dal piano di lavoro, per un totale di 600 mm.

EN— Desk divider panels to separate workstations allowing concentration and privacy. Simple and linear, to be fixed to the desk, they are in melamine or lacquered wood in the numerous colours in the catalogue. Available in various lengths, they are 454 mm high from the worktop, for a total of 600 mm.

F— Panneaux de séparation des bureaux pour diviser les postes de travail en favorisant la concentration et l'intimité. Simples et linéaires, à fixer sur le bureau, ils sont en bois mélaminé ou laqué dans les nombreuses teintes du catalogue. Disponibles en plusieurs longueurs, ils se situent à 454 mm du plan de travail, soit un total de 600 mm.



SCREEN / FRONT FABRIC
SCREEN / FRONT FABRIC
ÉCRAN / FRONT FABRIC

IT— Pannelli divisori da scrivania per dividere le postazioni garantendo comfort e favorendo concentrazione e privacy. Semplici e lineari, da fissare alla scrivania, sono interamente rivestiti in tessuto disponibili in un'ampia selezione di colori, per coniugare estetica e funzionalità. Disponibili in varie lunghezze, sono alti 454 mm dal piano di lavoro, per un totale di 600 mm.

EN— Desk divider panels to divide the workstations ensuring comfort and promoting concentration and privacy. Simple and linear, to be fixed to the desk, they are fully upholstered in fabric available in a wide selection of colors, to combine aesthetics and functionality. Available in various lengths, they are 454 mm high from the worktop, for a total of 600 mm.

F— Panneaux de séparation des bureaux pour diviser les postes de travail en assurant un confort et en favorisant la concentration et l'intimité. Simples et linéaires, à fixer sur le bureau, ils sont entièrement recouverts de tissu disponibles dans un large choix de couleurs, pour allier esthétique et fonctionnalité. Disponibles en plusieurs longueurs, ils sont situés à 454 mm du plan de travail, soit un total de 600 mm.

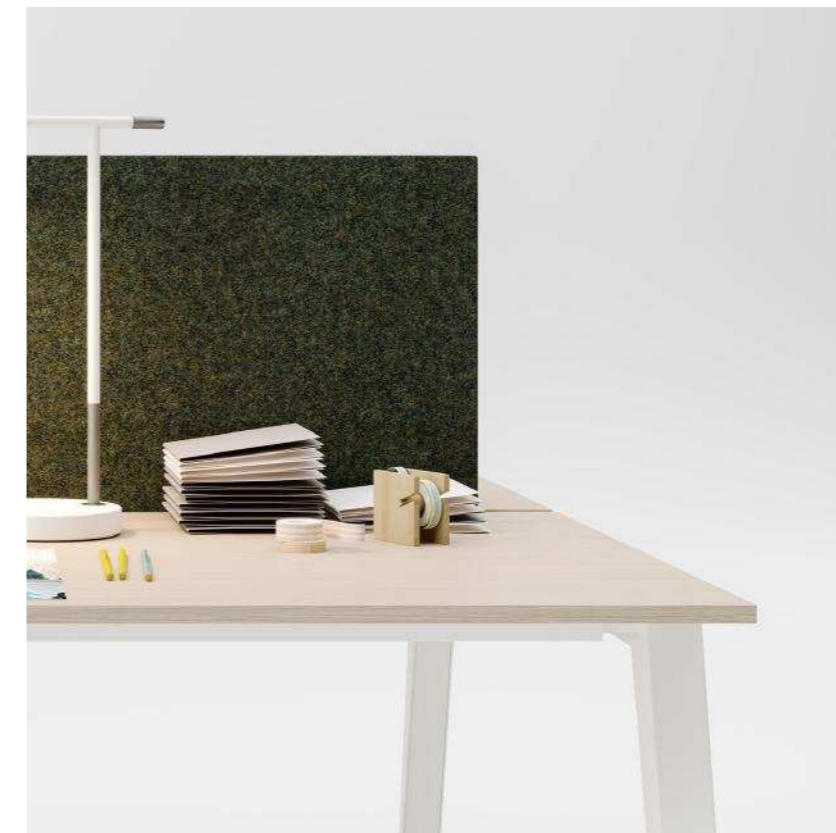



SCREEN / SOFT
SCREEN / SOFT
ÉCRAN / SOFT

IT— Pannelli divisori da scrivania per dividere le postazioni favorendo concentrazione e privacy. Semplici e arrotondati, da fissare alla scrivania, sono in legno melaminico o laccato nelle numerose tonalità a catalogo. Disponibili in varie lunghezze, sono alti 454 mm dal piano di lavoro, per un totale di 600 mm.

EN— Desk divider panels to separate workstations allowing concentration and privacy. Simple and rounded, to be fixed to the desk, they are in melamine or lacquered wood in the numerous colours in the catalogue. Available in various lengths, they are 454 mm high from the worktop, for a total of 600 mm.

F— Panneaux de séparation des bureaux pour diviser les postes de travail en favorisant la concentration et l'intimité. Simples et arrondis, ils sont en bois mélaminé ou laqué dans les nombreuses teintes du catalogue. Disponibles en plusieurs longueurs, ils se situent à 454 mm du plan de travail, soit un total de 600 mm.

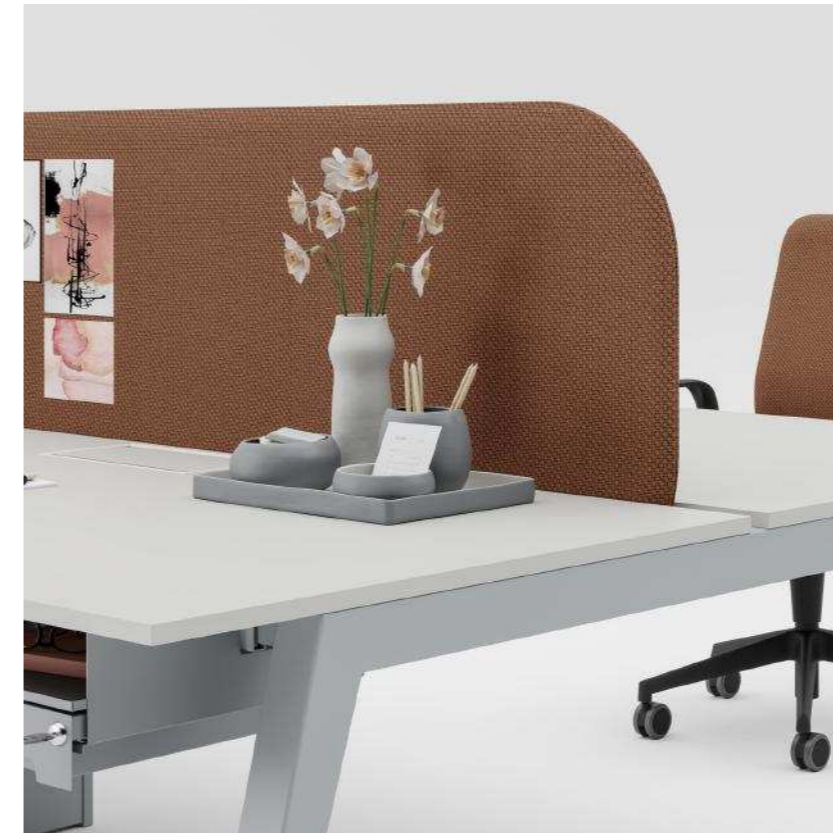
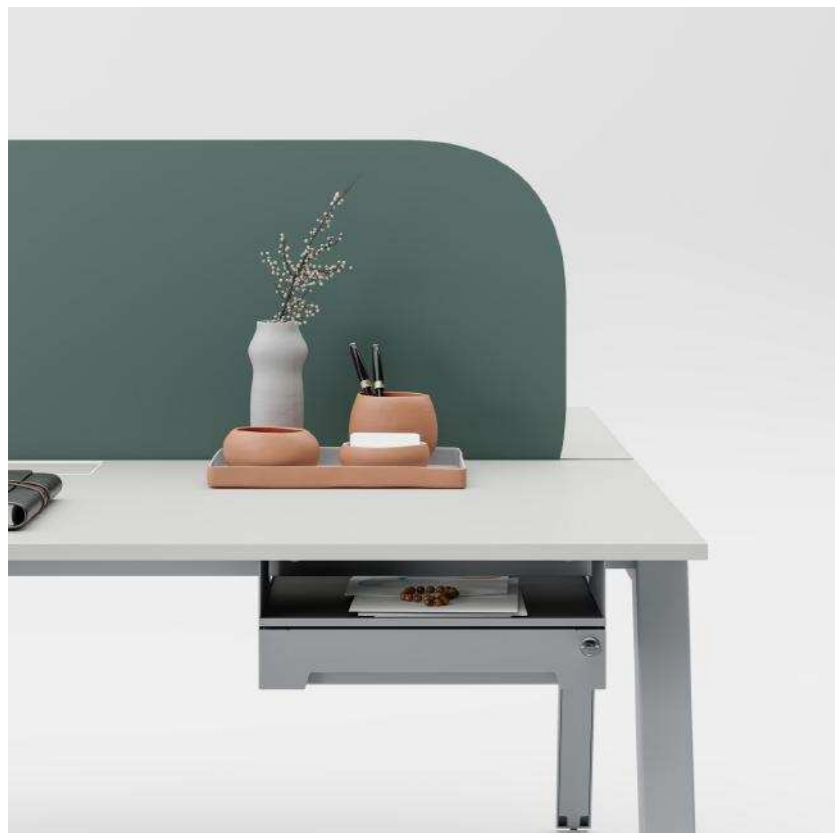

SCREEN / ACOUSTIC SOFT FABRIC
SCREEN / ACOUSTIC SOFT FABRIC
ÉCRAN / ACOUSTIC SOFT FABRIC

IT— Pannelli divisori da scrivania per dividere le postazioni garantendo comfort acustico e favorendo concentrazione e privacy. Dalla forma arrotondata e fissati alla scrivania, sono interamente rivestiti in tessuto con materiale fonoassorbente all'interno, disponibili in un'ampia selezione di colori, per coniugare estetica e funzionalità. Disponibili in varie lunghezze, sono alti 454 mm dal piano di lavoro, per un totale di 600 mm.

EN— Desk divider panels to divide the workstations ensuring acoustic comfort and promoting concentration and privacy. With their rounded shape and fixed to the top, they are fully upholstered in fabric with inner sound-absorbing material in a wide selection of colors, to combine aesthetics and functionality. Available in various lengths, they are 454 mm high from the worktop, for a total of 600 mm.

F— Panneaux de séparation des bureaux pour diviser les postes de travail en assurant un confort acoustique et en favorisant la concentration et l'intimité. De forme arrondie et fixés au bureau, ils sont entièrement recouverts de tissu avec un matériau insonorisant à l'intérieur dans un large choix de couleurs, pour allier esthétique et fonctionnalité. Disponibles en plusieurs longueurs, ils sont situés à 454 mm du plan de travail, soit un total de 600 mm.

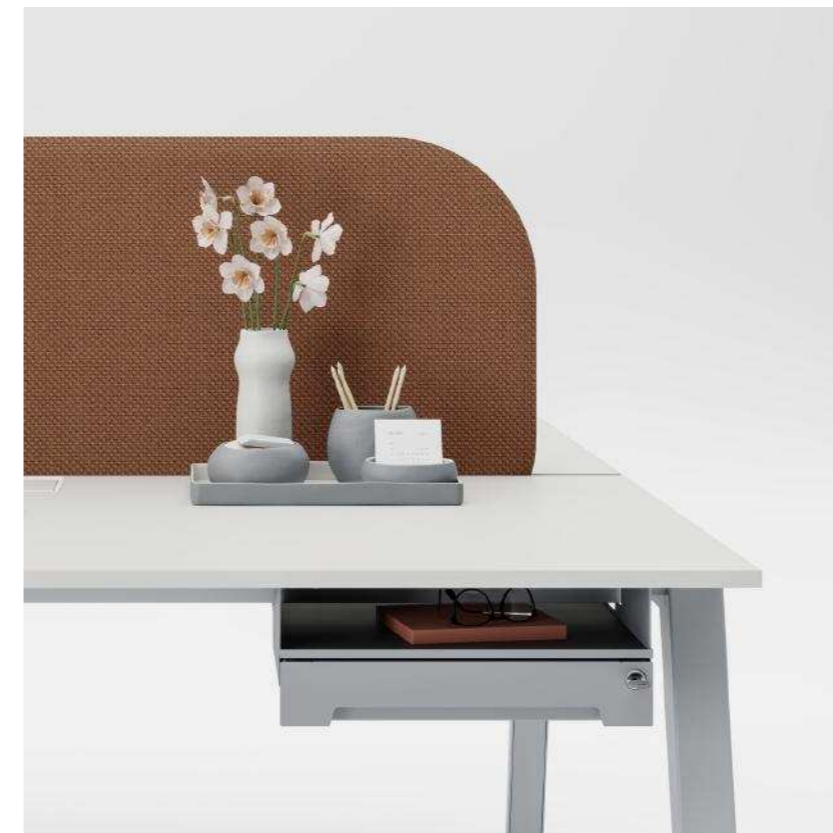



SCREEN / ACOUSTIC SOFT TRAY
 SCREEN / ACOUSTIC SOFT TRAY
 ÉCRAN / ACOUSTIC SOFT TRAY

IT— Pannelli divisori da scrivania freestanding, da posizionare liberamente sul piano di lavoro quando serve concentrazione, privacy e comfort acustico.

Dalla forma arrotondata, sono interamente rivestiti in tessuto con materiale fonoassorbente all'interno, disponibili in un'ampia selezione di colori, per coniugare estetica e funzionalità. Sono dotati di una base metallica che funge da comodo vassoio porta oggetti, verniciato in tinta o a contrasto nelle varie tonalità a catalogo. Disponibili in varie lunghezze, sono alti 454 mm dal piano di lavoro.

EN— Freestanding desk divider panels to be placed freely on the worktop, when you need concentration, privacy and acoustic comfort. With their rounded shape, they are fully upholstered in fabric with inner sound-absorbing material in a wide selection of colors, to combine aesthetics and functionality. They are equipped with a metal base that acts as a convenient tray for objects, painted in the same color or in contrast in the various shades. Available in various lengths, they are 454 mm high from the worktop.

F— Panneaux de séparation de bureau autoportante à placer librement sur le plan de travail lorsque la concentration, le confort acoustique et l'intimité sont nécessaires. De forme arrondie, ils sont entièrement recouverts de tissu avec un matériau insonorisant à l'intérieur dans un large choix de couleurs, pour allier esthétique et fonctionnalité. Il est équipé d'une base en métal qui agit comme un plateau pratique pour les objets, peints de la même couleur ou en contraste dans les différentes nuances. Disponibles en plusieurs longueurs, ils sont situés à 454 mm du plan de travail.

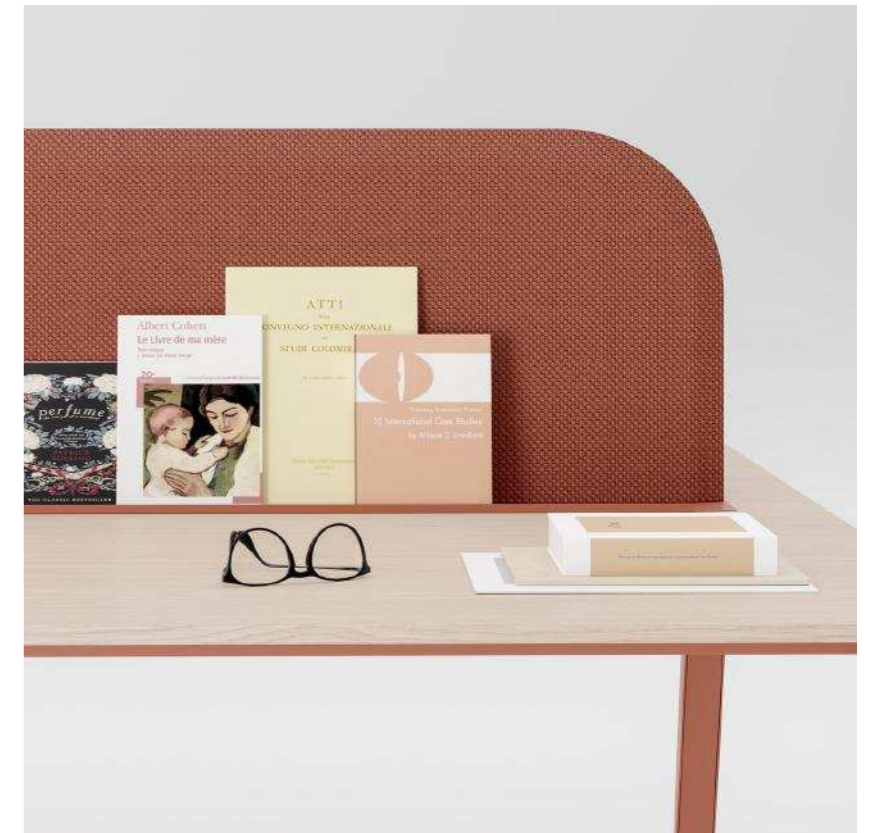



CASSETTO SMART PLUS
SMART PLUS DRAWER
TIROIR SMART PLUS

IT— La scrivania può essere attrezzata con un cassetto sottopiano metallico con serratura, disponibile nei colori metallici a catalogo.

EN— The desk can be equipped with a metal undertop drawer with lock, available in the metallic colours in the catalogue.

F— Le bureau peut être équipé d'un tiroir inférieur en métal avec serrure, disponible dans les couleurs métalliques du catalogue.



PORTA CPU
CPU HOLDER
PORTE CPU

IT— La scrivania può essere attrezzata con un porta CPU metallico sospeso fissato sottopiano o libero su ruote.

EN— The desk can be equipped with a suspended metal CPU holder fixed to the top, or free standing on castors.

F— Le bureau peut être équipé d'un support métallique suspendu pour l'ordinateur, fixé au dessus ou libre sur roulettes.





CASSETTIERA SU RUOTE
PEDESTAL DRAWERS UNIT ON CASTORS
CAISSON TIROIRS SUR ROULETTES

IT— Cassettiera in legno su ruote con tre cassetti e serratura. È disponibile in melaminico, laccato, Fenix e impiallacciato.

EN— Wooden pedestal three drawers unit on castors with lock. It is available in melamine, lacquered, Fenix and wood veneer.

F— Caisson tiroirs sur roulettes en bois avec trois tiroirs et serrure. Il est disponible en mélamine, laqué, Fenix et plaqué bois.

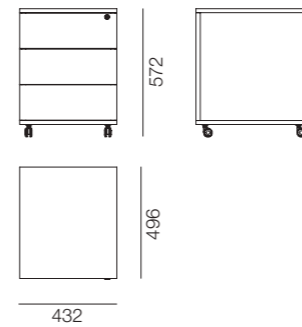



CASSETTIERA SU RUOTE
PEDESTAL DRAWERS UNIT ON CASTORS
CAISSON TIROIRS SUR ROULETTES

IT— Cassettiera in legno su ruote con due cassetti, serratura e vassoio porta oggetti. È disponibile in melaminico, laccato, Fenix e impiallacciato.

EN— Wooden pedestal two drawers unit on castors with lock and glove compartment. It is available in melamine, lacquered, Fenix and wood veneer.

F— Caisson tiroirs sur roulettes en bois avec deux tiroirs, serrure et plateau pour objets. Il est disponible en mélamine, laqué, Fenix et plaqué bois.

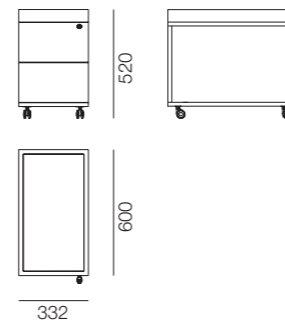

TAVOLO RIUNIONE
MEETING TABLE
TABLE DE RÉUNION

IT— Il tavolo riunione rettangolare è previsto in varie profondità e lunghezze. Ha una struttura metallica verniciata opaca nelle numerose tonalità a catalogo. Il piano può essere in legno melaminico, laccato, Fenix e impiallacciato con spessore di 18/19 mm. È anche previsto in vetro laccato anti touch e brillante o stampato effetto marmo anti touch e brillante. Il piano in vetro ha spessore totale 18 mm con lastre di 4 mm su supporto melaminico bianco o nero sp.14 mm con bordo in tinta con il piano. Il tavolo può essere canalizzato su richiesta.

EN— The rectangular meeting table is available in many depths and lengths. It has a matt varnished metal frame in the numerous catalogue colours. The top can be in melamine wood, lacquered, Fenix and wood veneer with a thickness of 18/19 mm. It is also available in anti-touch and brilliant lacquered glass or printed with anti-touch and brilliant marble effect. The glass top has a total thickness of 18 mm with sheets of 4 mm on a white or black melamine support 14 mm thick with edge matching the top. The table can be ducted on request.

F— La table de réunion rectangulaire est disponible en différentes profondeurs et longueurs. Il a une structure métallique vernie mate dans les nombreuses teintes du catalogue. Le plateau peut être en bois de mélamine, en laqué, en Fenix et en placage d'une épaisseur de 18/19 mm. Il est également disponible en verre laqué anti empreintes et brillant ou imprimé avec un effet marbre anti empreintes et brillant. Le plateau en verre a une épaisseur totale de 18 mm avec des feuilles de 4 mm sur un support en mélamine blanche ou noire de 14 mm d'épaisseur avec un bord assorti au plateau. La table peut être canalisée sur demande.

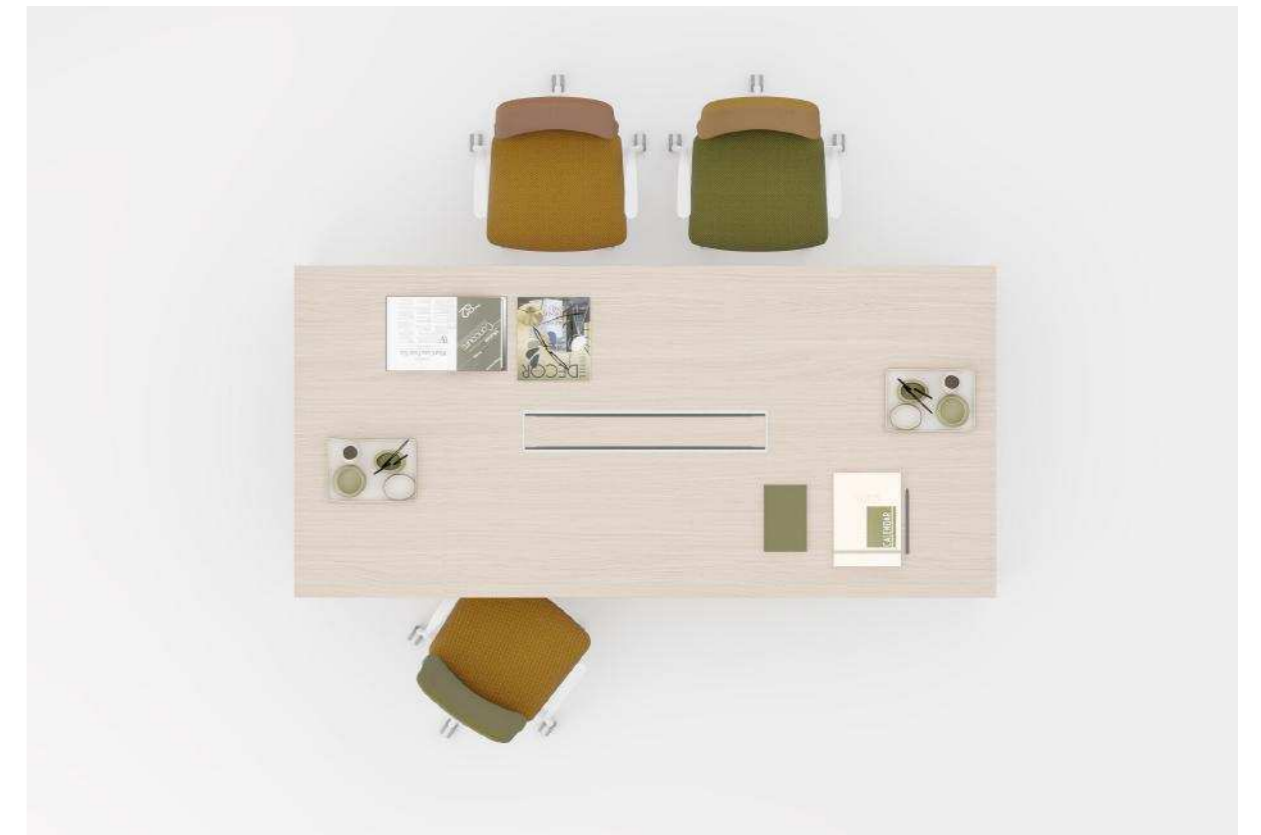
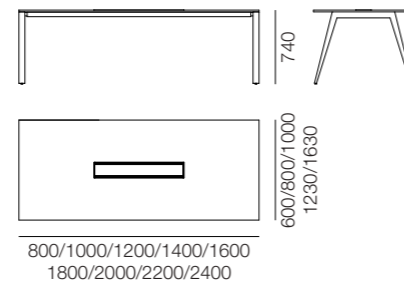

TAVOLO RIUNIONE MODULARE
MODULAR MEETING TABLE
TABLE DE RÉUNION MODULAIRE

IT— Il tavolo riunione rettangolare è previsto in varie profondità e lunghezze con piani componibili e gamba centrale condivisa per la canalizzazione verticale. Ha una struttura metallica verniciata opaca nelle numerose tonalità a catalogo. Il piano può essere in legno melaminico, laccato, Fenix e impiallacciato con spessore di 18/19 mm. È anche previsto in vetro laccato anti touch e brillante o stampato effetto marmo anti touch e brillante. Il piano in vetro ha spessore totale 18 mm con lastre di 4 mm su supporto melaminico bianco o nero sp.14 mm con bordo in tinta con il piano. Il tavolo può essere canalizzato su richiesta.

EN— The rectangular meeting table is available in many depths and lengths with modular tops and a shared central leg for vertical channelling. It has a matt varnished metal frame in the numerous catalogue colours. The top can be in melamine wood, lacquered, Fenix and wood veneer with a thickness of 18/19 mm. It is also available in anti-touch and brilliant lacquered glass or printed with anti-touch and brilliant marble effect. The glass top has a total thickness of 18 mm with sheets of 4 mm on a white or black melamine support 14 mm thick with edge matching the top. The table can be ducted on request.

F— La table de réunion rectangulaire est disponible en différentes profondeurs et longueurs avec des plateaux modulaires et un pied central partagé pour la canalisation verticale. Il a une structure métallique vernie mate dans les nombreuses teintes du catalogue. Le plateau peut être en bois de mélamine, en laqué, en Fenix et en placage d'une épaisseur de 18/19 mm. Il est également disponible en verre laqué anti empreintes et brillant ou imprimé avec un effet marbre anti empreintes et brillant. Le plateau en verre a une épaisseur totale de 18 mm avec des feuilles de 4 mm sur un support en mélamine blanche ou noire de 14 mm d'épaisseur avec un bord assorti au plateau. La table peut être canalisée sur demande.

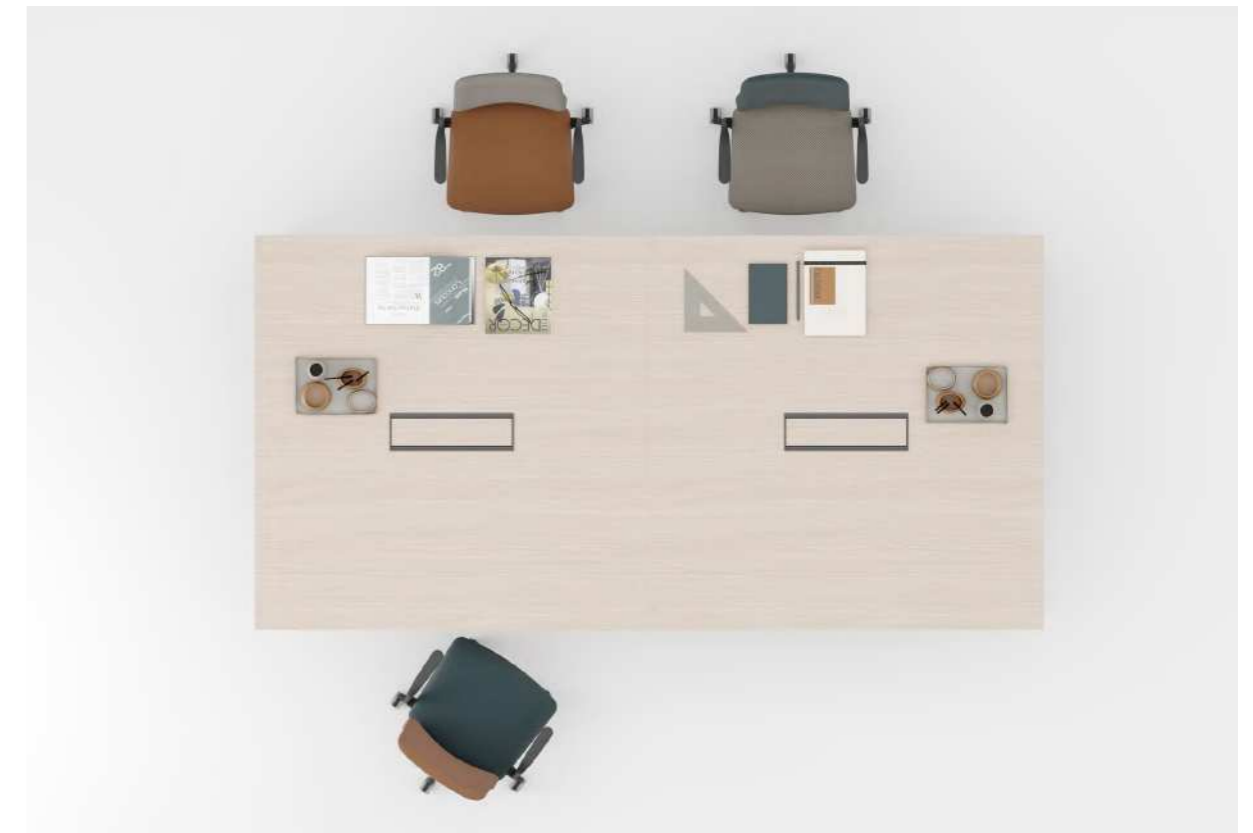
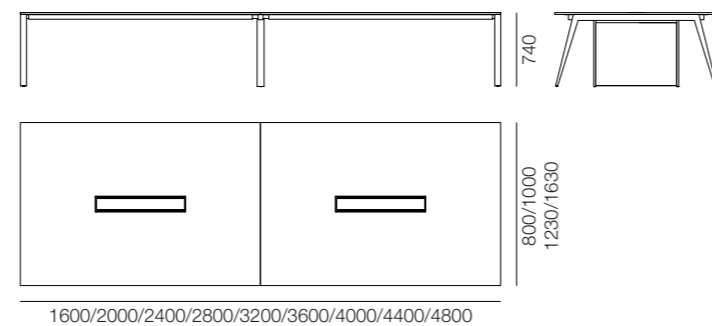

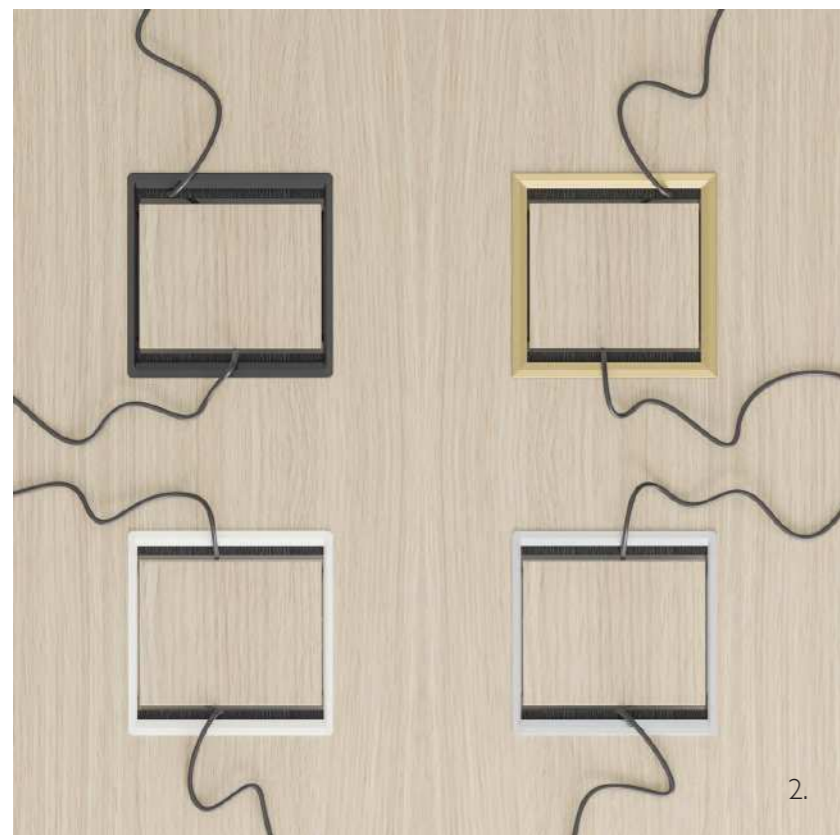
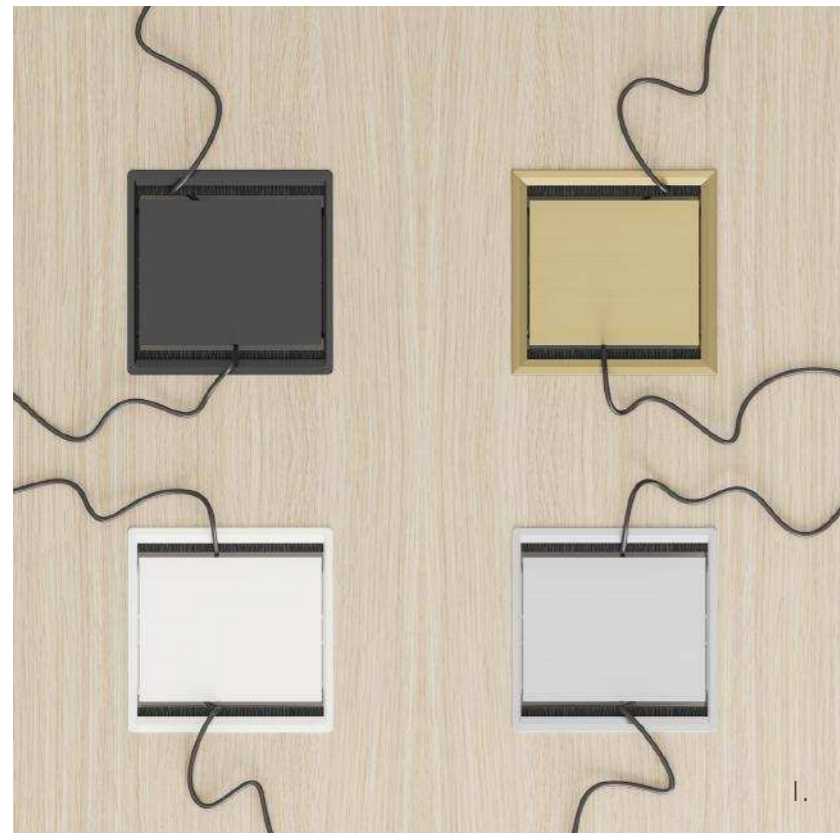

CANALIZZAZIONE / PASSACAVI
WIRING / CABLE TIDIES
CABLAGE / PASSE-CABLES

IT— 1. Il passacavo metallico Profcable è composto da profili e sportello in finitura anodizzata alluminio, nero, ottone e verniciato bianco. È realizzato con un sistema di doppia apertura basculante e rapido sistema di rimozione del coperchio, che permette un accesso veloce al cablaggio sottostante. È previsto in formato quadrato 150x150 mm e rettangolare largo 150 mm e in varie lunghezze.
2. Su richiesta è disponibile un pannello di finitura applicato sul coperchio per garantire continuità di finitura tra piano e passacavo ed una vaschetta di canalizzazione per multipresa.

3. In alternativa si può scegliere un passacavo rotondo in plastica ø 60 mm nei colori bianco, nero e grigio.
4. Oppure metallico ø 60 e 80 mm nei colori bianco, nero e inox.

EN— 1. The Profcable metal cable tidy is composed of profiles and titing panel in anodized aluminium, black, brass finish and white lacquered finish. It is made with a double tilting opening system and a quick access to the underlying wiring. It is available in square 150x150 mm and rectangular 150 mm wide and in various lengths.

2. Optional there is a finishing panel applied on the tilting cover to ensure the continuity of the finish between the top and the cable tidy and a cabling tray for multi-sockets.

3. Alternatively, it is possible to choose a round plastic cable tidy ø 60 mm in white, black and grey colors.
4. Or a metallic cable tidy ø 60 and 80 mm in white, black and inox colors.

F— 1. Le passe-cable métallique Profcable se compose de profils et d'une porte en aluminium anodisé, en noir, en laiton et en peinture blanche. Il est réalisé avec un système d'ouverture à double battant et un système de retrait rapide du couvercle, qui permet un accès rapide au câblage situé en dessous. Il est disponible en format carré de 150x150 mm et rectangulaire de 150 mm de large et en différentes longueurs.
2. Sur demande, un panneau de finition appliqué sur le couvercle est disponible pour garantir la continuité de la finition entre le dessus et le presse-étoupe et un plateau de canalisation pour les prises multiples.

3. En alternative, il est possible de choisir un passe-cable rond en plastique ø 60 mm en blanc, noir et gris.
4. Ou un passe-cable métallique ø 60 et 80 mm en couleur blanc, noir et inox.

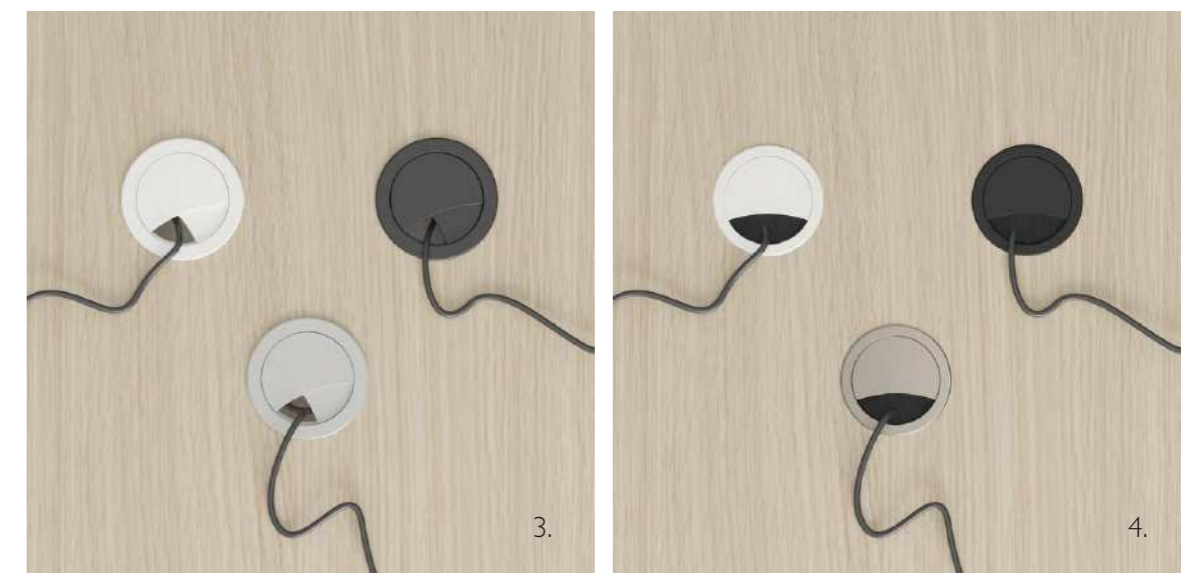
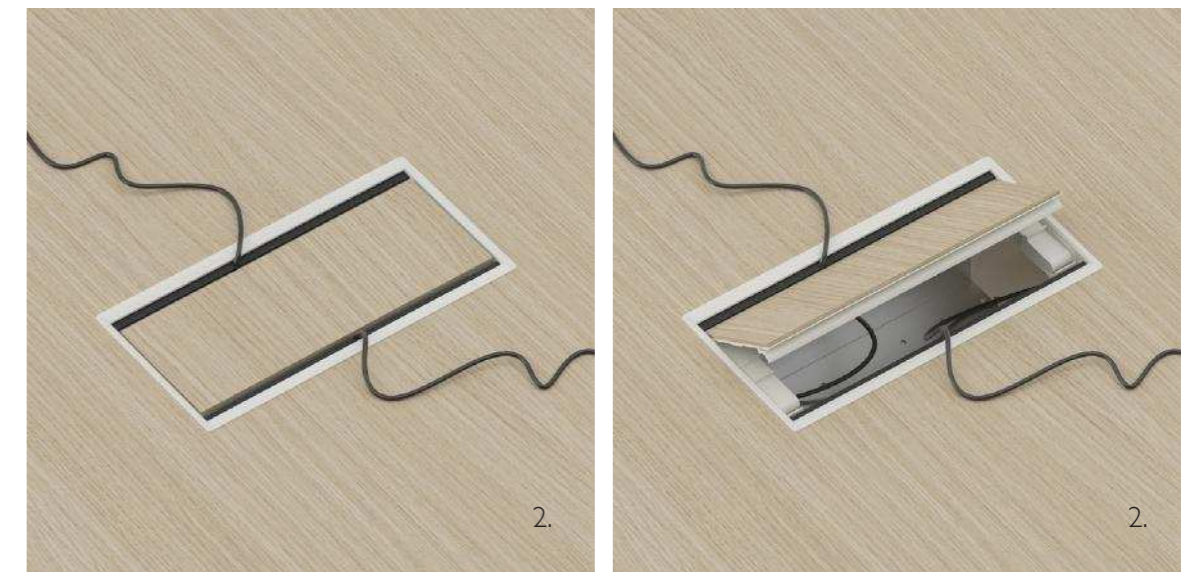
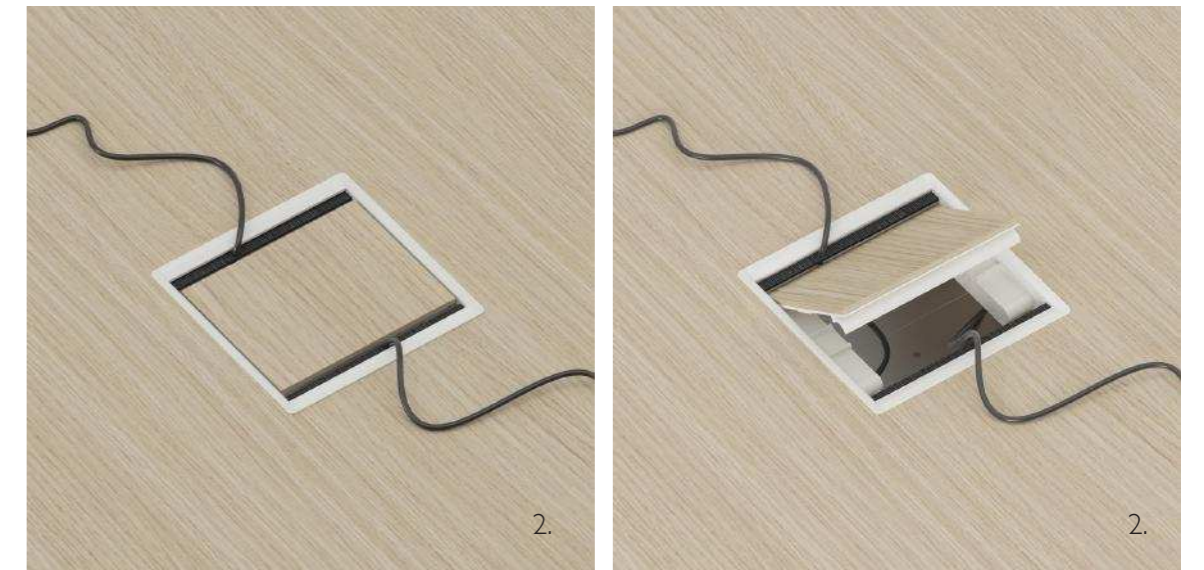



CANALIZZAZIONE / GESTIONE DEI CAVI
WIRING / CABLE MANAGEMENT
CABLAGE / GESTION DES CABLES

IT— 1. Scrivania singola: la gamba ha un carter metallico removibile che permette la risalita verticale dei cavi da terra.
2. Scrivania su Modular unit: il contenitore può avere un modulo porta CPU canalizzato.
Per la fuoriuscita sul piano è disponibile il Proficable metallico quadrato o rettangolare con vaschetta per multipresa.

EN— 1. Single desk: the leg has a removable metal casing that allows the cables to rise vertically from the floor.
2. Desk on Modular unit: the container can have a channeled CPU holder module.
The square or rectangular metal Proficable with tray for multi-socket outlets is available for the top.

F— 1. Bureau simple : le pied est doté d'un boîtier métallique amovible qui permet aux câbles de s'élever verticalement depuis le sol.
2. Bureau sur Modular unit: le conteneur peut avoir un module de support de CPU canalisé.
Le Proficable en métal carré ou rectangulaire est disponible avec un plateau pour multiprise.

1.



2.



3.

IT— 3 e 4. Scrivania bench e tavolo riunione: la gamba metallica centrale condivisa ha due carter a chiusura per la canalizzazione verticale dotati di magneti per facilitarne la rimozione. I cavi sotto piano vengono raccolti da cable grip fissati e da una vaschetta multipresa da integrare al Proficable per la fuoriuscita dei cavi sul piano.

EN— 3 e 4. Desk bench and meeting table: the shared central metal leg has two locking covers for vertical cable routing equipped with magnets for easy removal. Cables under the top are collected by fixed cable grips and by the multi-socket tray to be integrated with the Proficable for cable outlets on the top.

F— 3 e 4. Banc de bureau et table de réunion : le pied métallique central commun est doté de deux couvercles de verrouillage pour le passage vertical des câbles, équipés d'aimants pour un retrait facile. Les câbles sous le plateau sont collectés par des serre-câbles fixes et par le plateau multiprise à intégrer avec le Proficable pour la sortie des câbles sur le plateau.



4.

ACCESSORI / BOX E CUSCINO
 ACCESSORIES / BOX AND PILLOW
 ACCESSOIRES / BOÎTE ET COUSSIN

IT— BOX in legno porta piante o porta oggetti in altezza 150 mm con due profondità e due larghezze. Da posizionare sopra i mobili Profbox, Profslide e Modular unit per conferire un tocco di green all'ambiente, è disponibile in finitura melaminico o laccato nelle numerose tonalità a catalogo.
 CUSCINO sfoderabile imbottito con gommapiuma ingnifuga per mobile Modular unit. Da fissare tramite velcro biadesivo, è disponibile in unica misura 800x600 mm nei vari tessuti a catalogo.

EN— Wooden BOX for plants or objects in 150 mm height with two depths and two widths. To be placed on top of Profbox, Profslide and Modular unit furniture to give a touch of green to the environment, it is available in a melamine or lacquered finish in the numerous colours in the catalogue.
 Removable PILLOW with removable cover padded with non-refillable foam for Modular unit. To be fixed with double-sided velcro, it is available in one size in the various fabrics in the catalogue.

F— BOÎTE pour plantes ou objets en bois de 150 mm de hauteur avec deux profondeurs et deux largeurs. À placer sur les meubles Profbox, Profslide et Modular unit pour donner une touche de vert à l'environnement, il est disponible en finition mélaminée ou laquée dans les nombreuses couleurs du catalogue.
 COUSSIN amovible avec housse amovible rembourrée de caoutchouc mousse non rechargeable pour armoire Modular unit. À fixer avec du velcro double face, il est disponible en une seule taille dans les différents tissus du catalogue.

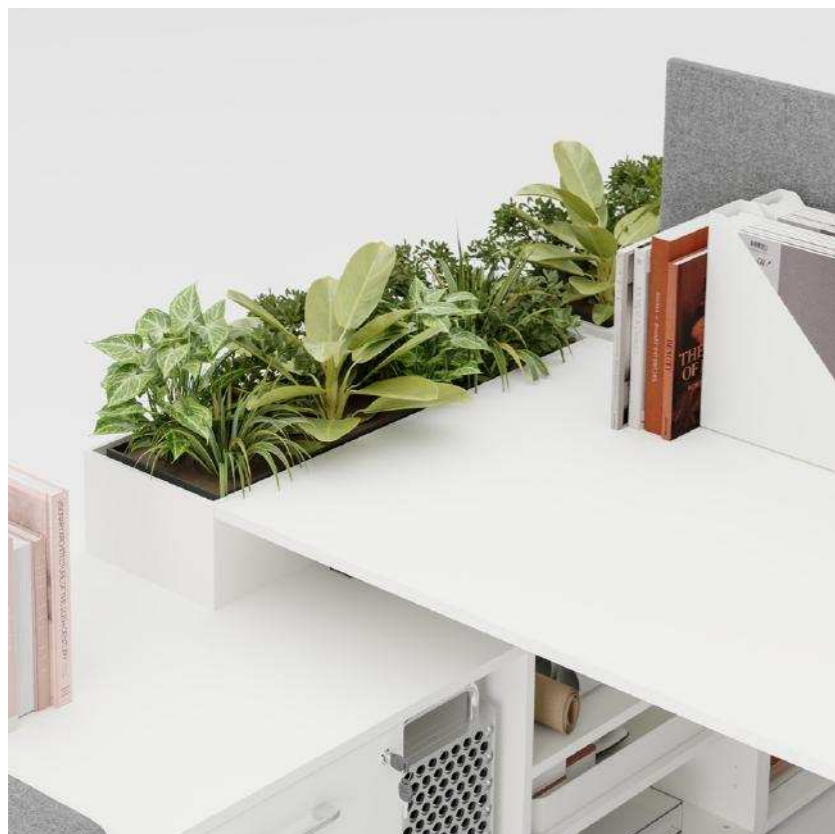

COMPLEMENTI / GETTACARTE E FIORIERA
 COMPLEMENTS / WASTEPAPER AND PLANTER
 COMPLÉMENTS / CORBEILLE ET PLANTER

IT— SQUARE è un gettacarte in legno melaminico disponibile nella versione singola o doppia, entrambe fornite di serie con ferma sacchetto superiore.
 SESSANTA è un complemento in legno melaminico da utilizzare come porta riviste o porta piante ad uso interno, da dotare di porta vaso. Fa parte di una collezione più ampia di tavoli caffè, disponibili quadrati e rettangolari in varie dimensioni e finiture.

EN— SQUARE is a melamine wooden wastepaper available in the single version or double, both of which come standard with top bag stopper.
 SESSANTA is a melamine wooden complement to use as a magazine or indoor plant holder, to be equipped with a vase holder. It is part of a wider collection of coffee tables, available square and rectangular in various sizes and finishes.

F— SQUARE est un enveloppe en bois disponible en version unique ou double, les deux étant livrés en standard avec un bouchon de sac supérieur.
 SESSANTA est un complément en bois à utiliser comme magasin ou planter intérieurs, à équiper d'un porte-vase. Il fait partie d'une collection plus large de tables basses, carrées et rectangulaires, disponibles en différentes tailles et finitions.



COMPLEMENTI / GETTACARTE E FIORIERA
COMPLEMENTS / WASTEPAPER AND PLANTER
COMPLÉMENTS / CORBEILLE ET PLANTER

IT— LOUISE è una collezione di fioriere da interno, portaombrelli e gettacarte. Complementi eleganti e sofisticati, divengono veri e propri elementi di arredo per interni, perfetti per ambienti lavorativi e domestici. La struttura è in metallo verniciata nelle numerose tonalità previste a catalogo. Il rivestimento è in vetro effetto marmo o tinta unita, effetto brillante o antitouch, da giocare tono su tono o in contrasto cromatico. Per facilitare il movimento, sono dotati di ruote a scomparsa totale.

Il GETTACARTE è disponibile in due misure, con funzione di cestino singolo o doppio.

La FIORIERA è quadrata e rettangolare in tre varianti dimensionali, da utilizzare singolarmente o riunite in composizioni.

EN— LOUISE is a collection of indoor planters, wastepaper and umbrella stand. Refined and sophisticated, they become genuine interior design accessories, perfect for both work and home environments. The structure is in matt varnished metal in several finishes included in the catalog. The covering is in printed glass or single color, with brilliant or anti touch effect to play tone on tone or in color contrast. To facilitate movement they are equipped with recessed wheels.

The WASTEPAPER is available in two sizes as single or double. The PLANTER is square and rectangular, available in three different sizes to use singly or in compositions.

F— LOUISE est une collection de planters intérieurs, corbeille à papier et porte-parapluies. Précieux et raffinés, ces bacs à fleurs s'insèrent parfaitement dans la décoration d'intérieur, idéaux dans des espaces de travail et chez soi. La structure est en métal, peinte dans les nombreuses couleurs disponibles dans le catalogue. Les revêtements sont en verre imprimé effet marbre ou en couleur unie, brillants ou anti empreintes, à jouer ton sur ton ou en couleurs contrastantes. Pour faciliter les déplacements, ils sont équipés de roulettes entièrement escamotables.

Le CORBEILLE À PAPIER est disponible en deux tailles avec fonction simple ou double. Le BAC À FLEURS est carré et rectangulaire en trois tailles différentes à utiliser seuls ou assortis les uns aux autres.

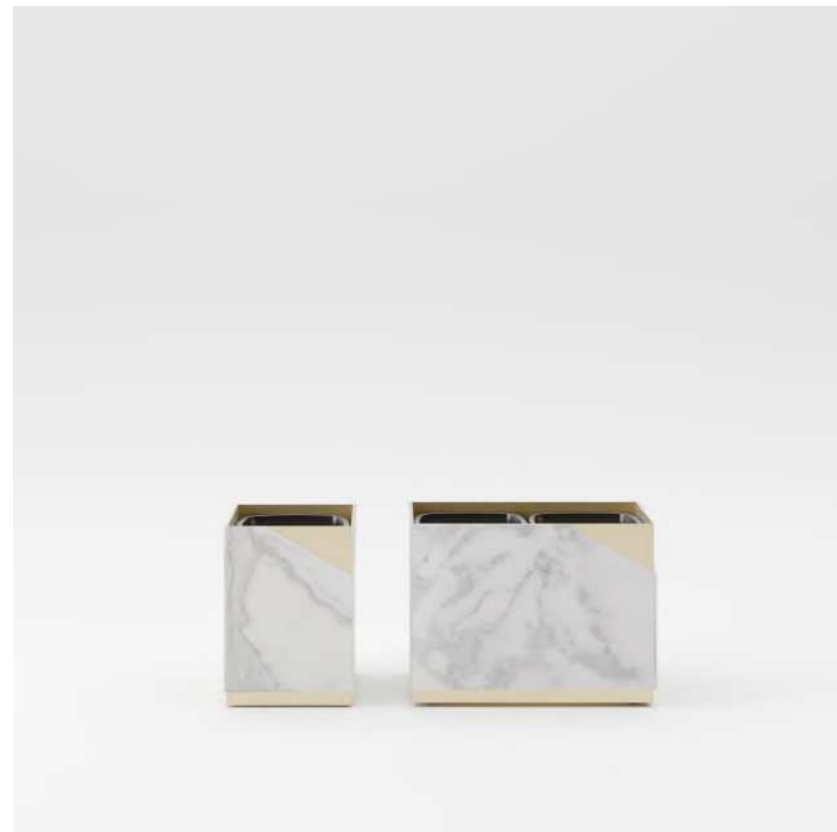

COMPLEMENTI / APPENDIABITI E TAVOLI CAFFÈ
COMPLEMENTS / COAT STANDS AND COFFEE TABLES
COMPLÉMENTS / CINTRES A VETEMENTS ET TABLES BASSES

IT— L'appendiabiti JANE ha una struttura metallica verniciata opaca con base circolare, stelo e tre bracci disponibili nell'ampia gamma di tonalità a catalogo. I bracci montano sei sfere con particolari che possono essere in ottone spazzolato, nichel spazzolato, nichel nero spazzolato. Per un aspetto ancora più prezioso, la base circolare è prevista anche in marmo. Essenziale e decorativo, si inserisce perfettamente in ambienti di stili e contesti diversi con massima libertà di personalizzazione.

La collezione TABLE è una famiglia di tavoli riunione, tavoli caffè, tavoli alti e tavoli lounge. Di forma rotonda, quadrata, rettangolare e ovale, sono disponibili in varie misure e altezze.

La struttura del tavolo è in tubolare metallico con piastre superiori e inferiori verniciate opache nelle finiture a catalogo. Il piano è disponibile con bordo a saponetta o con bordo dritto in tutte le finiture disponibili a catalogo.

EN— JANE coat stand has a matt varnished metal structure with circular base, stem and three arms available in the wide range of colours in the catalogue. The arms assemble six spheres with details that can be in brushed brass, brushed nickel, brushed black nickel. For a more precious appearance, the circular base is also available in marble. Essential and decorative, it fits perfectly in environments of different styles and contexts with maximum freedom of customization.

The TABLE collection is a family of meeting tables, coffee tables, high tables and lounge tables. Round, square, rectangular and oval in shape, they are available in various sizes and heights. The structure of the table is in metal tubular with upper and lower plates matt painted in the catalogue finishes. The top is available with a waterfall edge or with a straight edge in all the finishes available in the catalogue.

F— Le porte-manteau JANE a une structure en métal verni mat avec une base circulaire, une tige et trois bras disponibles dans la large gamme de teintes du catalogue. Les bras portent six sphères avec des détails qui peuvent être en laiton brossé, en nickel brossé, en nickel noir brossé. Pour un aspect encore plus précieux, la base circulaire est également disponible en marbre. Essentiel et décoratif, il s'intègre parfaitement dans des environnements de styles et de contextes différents avec une liberté de personnalisation maximale.

La collection TABLE est une famille de tables de réunion, tables basses, tables hautes et tables basses. De forme ronde, carrée, rectangulaire et ovale, ils sont disponibles en différentes tailles et hauteurs. La structure de la table est en tube métallique avec des plaques supérieure et inférieure peintes mates dans les finitions du catalogue. Le plateau est disponible avec un bord façonné ou avec un bord droit dans toutes les finitions disponibles dans le catalogue.



COMPLEMENTI / SOTTOMANO E SET SCRIVANIA
 COMPLEMENTS / UNDERHAND AND DESK SET
 COMPLÉMENTS / SOUS MAIN ET SET DE BUREAU

IT— SKIN è un sottomano in cuoietto rigenerato per scrivanie. Semplice ed elegante, con cuciture in rilievo e un fondo antiscivolo che lo mantiene in posizione. Disponibile in quattro tonalità: bianco, nero, basalto, testa di moro e cuoio. SOPHIE è un set scrivania composto da cinque elementi: vassoio, porta penne, porta oggetti, porta biglietti da visita e vaso mono fiore. Ogni pezzo è originale e interamente fatto a mano in terracotta smaltata con effetto opaco mono e bicolore.

EN— SKIN is a regenerated leather underhand for desks. Simple and elegant, with embossed stitching and a non-slip bottom that keeps it in place. Available in four colours: white, black, basalt, dark brown and cuoio. SOPHIE is a set of five elements: tray, pen holder, object holder, visiting card holder and single-flower vase. Each piece is original and exclusive, made entirely by hand in matte glazed one or two-colour terracotta.

F— SKIN est un sous-main en cuir régénéré pour les bureaux. Simple et élégant, avec des surpiqûres en relief et un fond antidérapant qui le maintient en place. Disponible en quatre teintes: blanc, noir, basalte, brun foncé et cuir. SOPHIE est une set de bureau avec cinq pièces: un plateau, un porte-stylos, un porte-objet, un porte-cartes de visite et un vase mono-fleur. Chaque pièce est originale et entièrement réalisée à la main en terre cuite émaillée, effet mat monochrome ou deux tons.

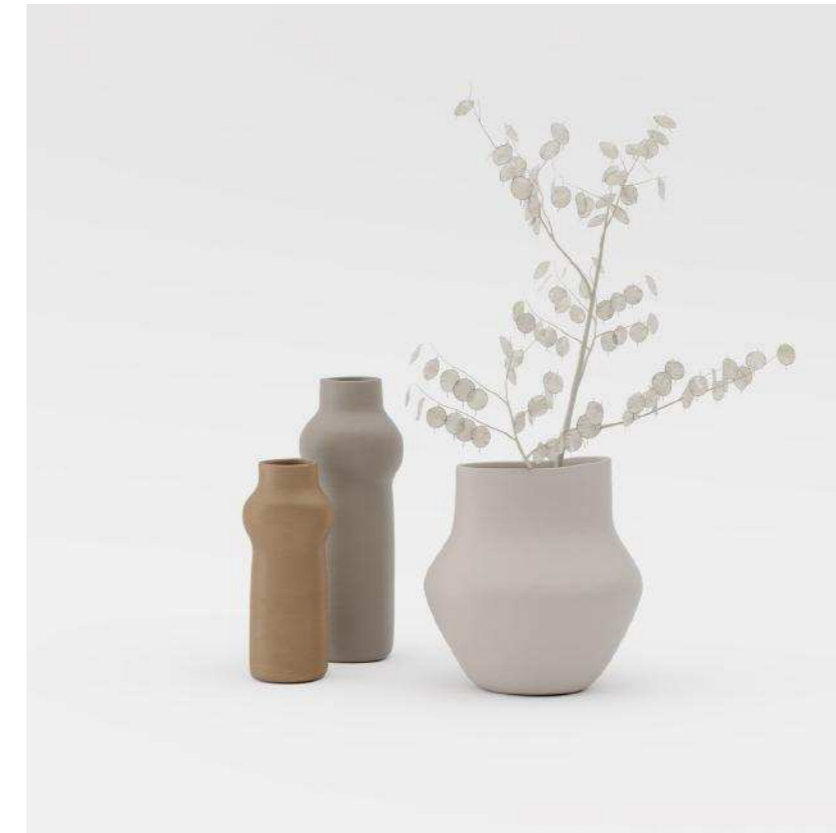
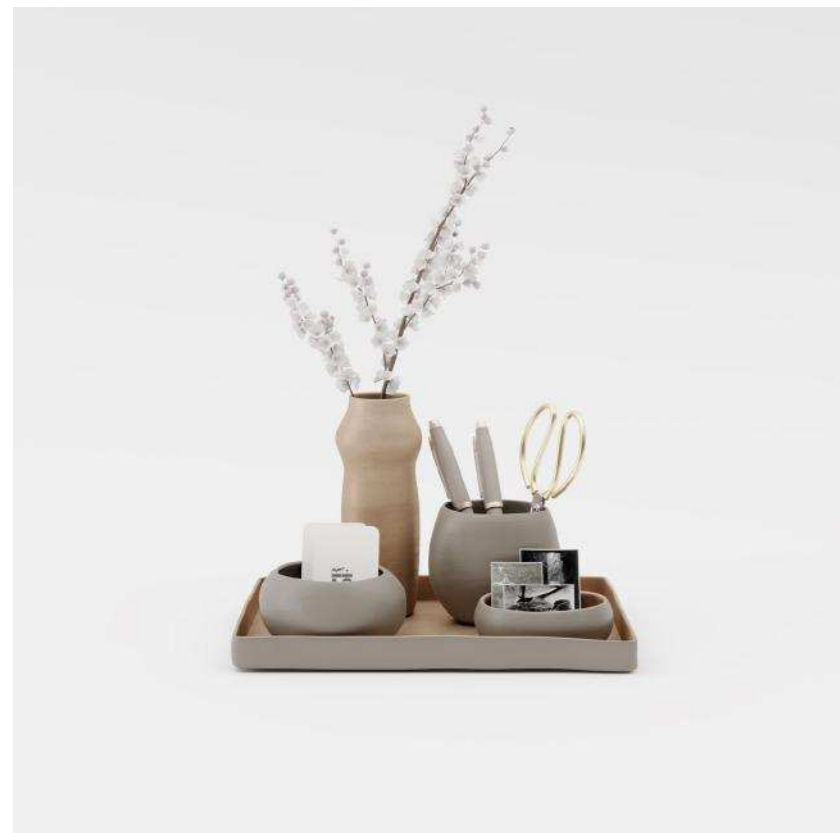

COMPLEMENTI / VASI
 COMPLEMENTS / VASES
 COMPLÉMENTS / VASES

IT— OLIVIA, INGRID e BLOOM sono set di vasi e ciotole fatti interamente a mano in terracotta smaltata con effetto opaco.

EN— OLIVIA, INGRID and BLOOM are set of vases and bowls made entirely by hand in matte glazed terracotta.

F— OLIVIA, INGRID et BLOOM sont set de vases boules fabriquées à la main en terre cuite émaillée effet mat.



creative & design direction
RMDESIGNSTUDIO / Mariella Vidotti

graphic design & copywriting
RMDESIGNSTUDIO

product design
R&S PROF

photos
concept, set design & styling / RMDESIGNSTUDIO
rendering & styling / SALAPOSA STUDIO

Digital preview
September 2021

L'azienda si riserva in qualunque momento di apportare senza preavviso modifiche a prodotti, accessori e finiture.

The Manufacturer reserves the right to modify products, accessories and finishings at any time without prior notice.

La Société se réserve le droit à tout moment de faire des changements sans préavis aux produits, accessoires et finitions.

Prof srl - Azienda certificata / Certified Company / Entreprise certifiée



PROF

PROF srl
Via Cao de Villa 6/A
Località Falzè di Piave
31020 Sernaglia della Battaglia, TV / Italy
T +39 0438 903190 F +39 0438 903228
p.iva / cod.fisc IT03134570260
www.profoffice.it info@profoffice.it

