

SESSANTA

executive collection



PR
OF

SESSANTA

executive collection



PR
OF

« CONTENTS »

PAG. 04
CHAPTER 01 - THE COLLECTION

PAG. 06
CHAPTER 02 - THE CATALOGUE

PAG. 08
CHAPTER 03 - VENEER

PAG. 34
CHAPTER 04 - FENIX

PAG. 70
CHAPTER 05 - MELAMINE

PAG. 82
CHAPTER 06 - TECHNICALS





« THE COLLECTION »

IT— In un gioco di finiture a contrasto, la collezione direzionale SESSANTA si rinnova con l'introduzione di nuovi materiali dalle superfici preziose, come i legni impiallacciati e i colori Fenix NTM®. Si aggiungono anche numerose finiture melaminiche di legni e tinte unite. A completare, varie tonalità di cuoio per arricchire le superfici degli spazi di lavoro.

Dalle linee essenziali, la SCRIVANIA è caratterizzata da un piano e una struttura in legno nello spessore 60 mm. È declinata in varie versioni, ciascuna corredata da elementi che la rendono estremamente funzionale alle diverse esigenze. I TAVOLI RIUNIONE rettangolari, disponibili in diverse misure, hanno piano e basamento in legno e sono dotati di fascia centrale per la canalizzazione. In più dimensioni, sono previsti i tavoli rotondi con struttura metallica a colonna. In un equilibrio di pieni e vuoti, i CONTENITORI sono proposti in tre altezze e sono attrezzati con cassettoni, vani a giorno, ante a battente e a ribalta. La CONSOLLE è caratterizzata da cassetti sporgenti e vani a giorno. I TAVOLINI CAFFÈ sono disponibili in tre dimensioni e sono proposti come elementi di arredo singoli o aggregati tra loro.

SESSANTA si conferma oggi un programma sempre più versatile e completo, capace di personalizzare gli spazi e facilmente adattabile ad ambienti sia di lavoro, che contract e home office.

EN— In a game of contrasting finishes, the SESSANTA executive collection is renewed with the introduction of new materials with precious surfaces, such as veneered woods and Fenix NTM® colors. There are also numerous melamine finishes of woods and plain colors. To complete, various shades of leather to enrich the surfaces of the work spaces.

With essential lines, the DESK is characterized by a top and a wooden structure in the 60 mm thickness. It is available in various versions, each accompanied by elements that make it extremely functional for different needs. Rectangular MEETING TABLES, available in different sizes, have a wooden top and base and are equipped with a central cabling channel. In several dimensions, round tables with a metal column structure are provided. In a balance of solids and voids, the CONTAINERS are offered in three heights and are equipped with drawers, open compartments, hinged and flap doors. The CONSOLE is characterized by protruding drawers and open compartments. COFFEE TABLES are available in three sizes and are offered as single or aggregate furnishing elements.

SESSANTA confirms itself today as an increasingly versatile and complete program, capable of customizing spaces and easily adaptable to both work environments, contract and home offices.

F— Dans un jeu de finitions contrastées, la collection exécutive SESSANTA est renouvelée avec l'introduction de nouveaux matériaux aux surfaces précieuses, tels que les bois plaqués et les couleurs Fenix NTM®. Il existe également de nombreuses finitions en mélamine de bois et de couleurs unies. Pour compléter, différentes nuances de cuir pour enrichir les surfaces des espaces de travail.

Avec ses lignes essentielles, le BUREAU se caractérise par un plateau supérieur et une structure en bois de 60 mm d'épaisseur. Il est disponible en différentes versions, chacune accompagnée d'éléments qui le rendent extrêmement fonctionnel pour des besoins différents. Les TABLES DE RÉUNION rectangulaires, disponibles en différentes mesures, ont un plateau et une base en bois et sont équipées d'un canal central pour le raccordement des câbles. Dans plusieurs dimensions, des tables rondes avec une structure à colonnes en métal sont maintenant fournies. Dans un équilibre de solides et de vides, les ARMOIRES sont proposés dans trois hauteurs et sont équipés de tiroirs, de compartiments ouverts, de portes battantes et à battants. La CONSOLLE se caractérise par des tiroirs saillants et des compartiments ouverts. Les TABLES À CAFÉ sont disponibles en trois tailles et sont proposées en tant qu'éléments d'ameublement simples ou agrégés.

SESSANTA s'affirme aujourd'hui comme un programme de plus en plus polyvalent et complet, capable de personnaliser les espaces et facilement adaptable aux environnements de travail, aux contrats et aux bureaux à domicile.



« THE CATALOGUE »



IT — Prof presenta la collezione direzionale SESSANTA attraverso sei progetti completi di ambienti di lavoro. Protagonisti indiscussi tutti gli elementi del programma, che insieme ai complementi Profmood, interpretano con naturale eleganza e personalità l'ufficio contemporaneo. Sei proposte di combinazioni di materiali e finiture divise in tre categorie: IMPIALLACCIATO, FENIX, MELAMINICO per illustrare le numerose possibilità compositive della collezione.

EN — Prof presents the SESSANTA executive collection through six complete workspace projects. The undisputed protagonists are all the elements of the program, which together with the Profmood complements, interpret the contemporary office with natural elegance and personality. Six proposals for combinations of materials and finishes divided into three categories: VENEER, FENIX, MELAMINE to illustrate the numerous compositional possibilities of the collection.

F — Prof présente la collection directionnelle SESSANTA à travers six projets complets d'espaces de travail. Les protagonistes incontestés sont tous les éléments du programme qui, avec les compléments Profmood, interprètent le bureau contemporain avec une élégance et une personnalité naturelles. Six propositions de combinaisons de matériaux et de finitions divisées en trois catégories: PLAQUÉ, FENIX, MÉLAMINÉ pour illustrer les nombreuses possibilités de composition de la collection.



VENEER
01

01
IMPIALLACCIATO LEGNO
IM1 50 rovere termotrattato

02
COLORE MELAMINICO
MC 32 curry

03
COLORE MELAMINICO
MC 25 tabacco

04
CUOINETTO RIGENERATO
PC 96 testa di moro

01
WOOD VENEER
IM1 50 thermotreated oak

02
MELAMINE COLOR
MC 32 curry

03
MELAMINE COLOR
MC 25 tobacco

04
REGENERATED LEATHER
PC 96 dark brown

01
PLAQUÉ BOIS
IM1 50 chêne traité thermiquement

02
COULEUR MÉLAMINÉE
MC 32 curry

03
COULEUR MÉLAMINÉE
MC 25 tabac

04
CUIR RECONSTITUÉ
PC 96 brun foncé

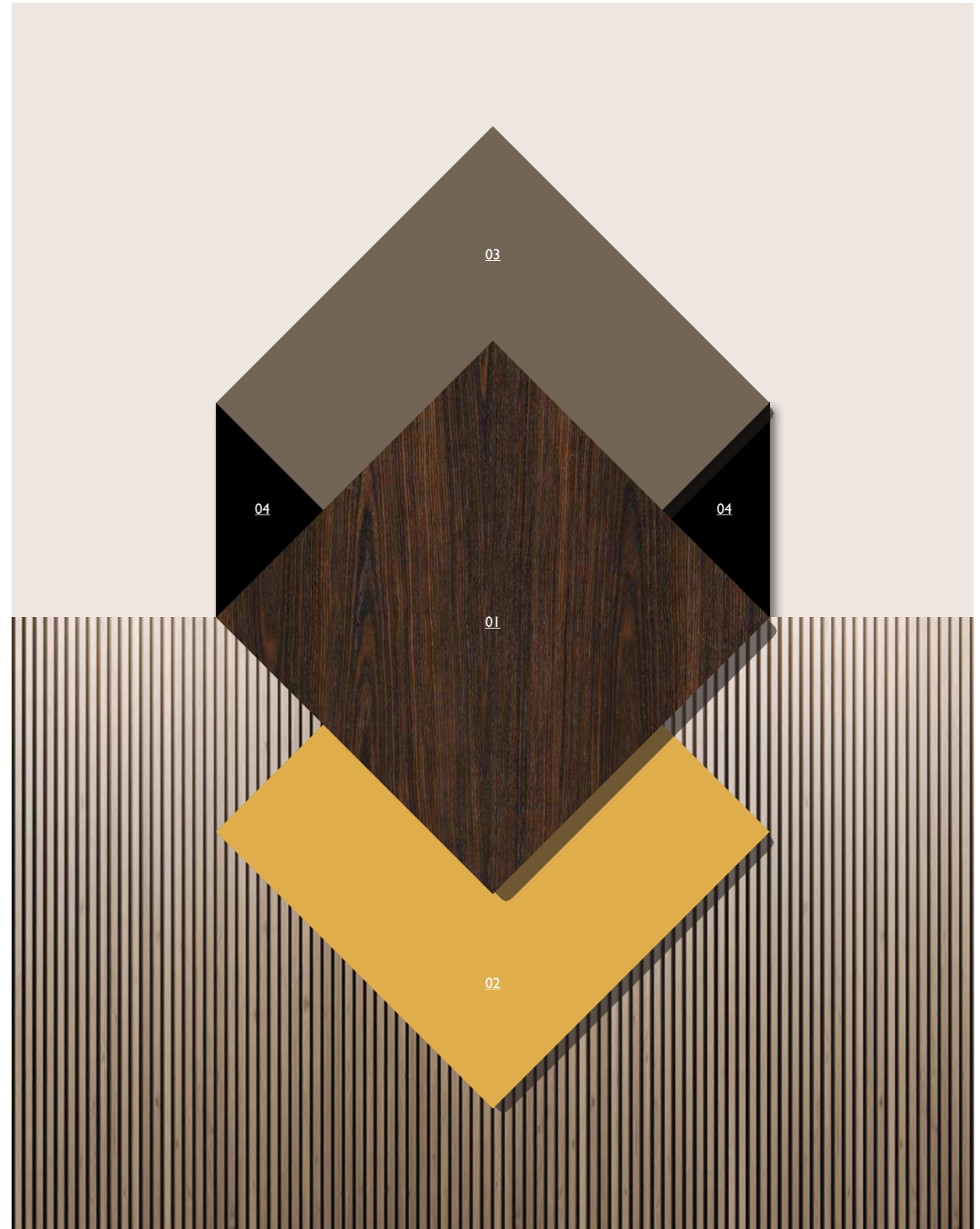

Veneer 01

rovere termotrattato / tabacco / curry / testa di moro
 thermotreated oak / tobacco / curry / dark brown
 chêne traité thermiquement / tabac / curry / brun foncé

IT— Massimo prestigio e funzionalità per la scrivania presentata in un inedito accostamento di legno impiallacciato rovere termotrattato e tabacco melaminico. La versione President integra un ampio mobile di servizio canalizzato con cassettiera e vani a giorno. Dalle forme semplici, le madie sono proposte nelle due altezze previste nelle stesse finiture, con l'aggiunta di un accento di colore curry. Il tavolo riunione ha la base in rovere termotrattato e il piano interamente rivestito in cuoietto rigenerato testa di moro con cuciture a vista, per conferire un aspetto ancora più elegante e ricercato. I pannelli centrali celano due vani interni per il passaggio dei cavi. La consolle è caratterizzata da cassetti sporgenti e vani a giorno, giocati nelle finiture rovere termotrattato e tabacco. Come elementi di arredo singoli o aggregati tra loro, i tavolini caffè sono disponibili in varie dimensioni con effetti di materiali a contrasto, qui nelle combinazioni rovere termotrattato, tabacco e curry.

EN— Maximum prestige and functionality for the desk presented in a new combination of thermotreated oak veneer and melamine tobacco. The President version integrates a large channeled supporting cabinet with pedestal drawers unit and open compartments. With simple shapes, the sideboards are offered in two heights in the same finishes, with the addition of a curry color accent. The meeting table has a thermotreated oak base and the top is completely covered in dark brown regenerated leather with visible stitching, to give it an even more elegant and refined look. The central panels conceal two internal compartments for the passage of cables. The console is characterized by protruding drawers and open compartments, played in the thermotreated oak and tobacco finishes. As individual or aggregate furnishing elements, the coffee tables are available in various sizes with contrasting material effects, here in the combinations thermotreated oak, tobacco and curry.

F— Prestige et fonctionnalité maximum pour le bureau présenté dans une nouvelle combinaison de placage de chêne traité thermiquement et de tabac mélaminé. La version President intègre une grande meuble de support canalisé avec caisson tiroirs et compartiments ouverts. Avec des formes simples, les buffets sont proposés dans deux hauteurs dans les mêmes finitions, avec l'ajout d'un accent de couleur curry. La table de réunion a une base en chêne traité thermiquement et le plateau est entièrement recouvert de cuir reconstitué marron foncé avec surpiqûres apparentes, pour lui donner un aspect encore plus élégant et raffiné. Les panneaux centraux cachent deux compartiments internes pour le passage des câbles. La console est caractérisée par des tiroirs en saillie et des compartiments ouverts, joués dans les finitions chêne traité thermiquement et tabac. Comme les éléments d'ameublement individuels ou en agrégats, les tables basses sont disponibles dans différentes tailles avec des effets de matériaux contrastés, ici dans les combinaisons chêne traité thermiquement, tabac et curry.





PRESIDENT DESK — 2600 x 1979 x H 760 mm

VENEER 01



SIDEBOARD — 1842 x 510 x H 1316 mm



SIDEBOARD — 1842 x 510 x H 900 mm





MEETING TABLE — 3540 x 1400 x H 760 mm





CONSOLE — 1660 x 460 x H 863 mm



COFFEE TABLES — 400 x 400 x H 400 mm
800 x 800 x H 294 mm

02
VENEER
02

01
IMPIALLACCIATO LEGNO
IM2 48 ebano Makassar lucido

02
COLORE MELAMINICO
MC 23 cappuccino

01
WOOD VENEER
IM2 48 polish Makassar ebony

02
MELAMINE COLOR
MC 23 cappuccino

01
PLAQUÉ BOIS
IM2 48 ébène Makassar brillant

02
COULEUR MÉLAMINÉE
MC 23 cappuccino

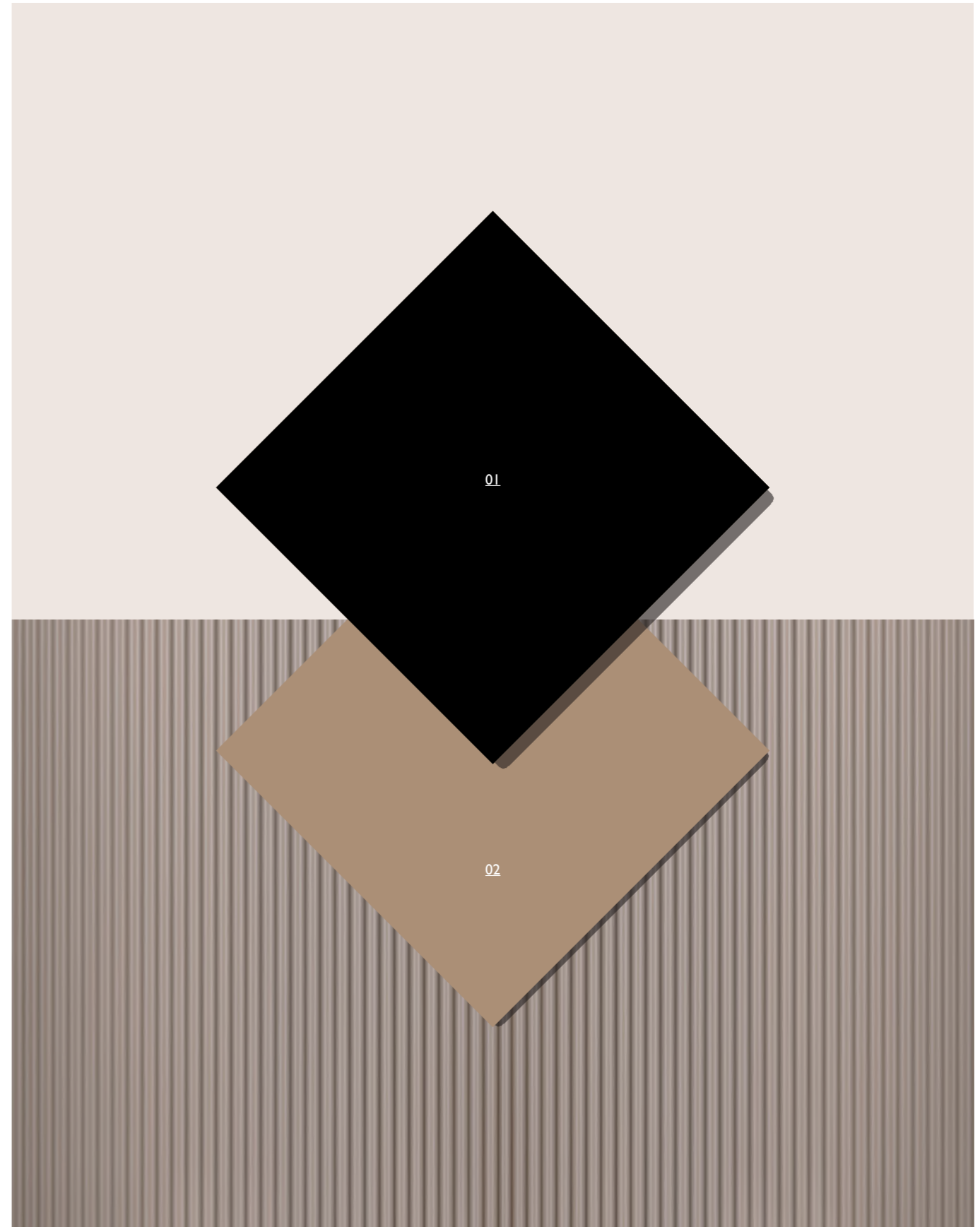

Veneer 02

ebano Makassar lucido / cappuccino
 polish Makassar ebony / cappuccino
 ébène Makassar brillant / cappuccino

IT— La scrivania in versione President plus è qui proposta nell'abbinamento legno impiallacciato ebano Makassar lucido e cappuccino. Prestigioso e funzionale, il tavolo riunione, qui proposto nelle stesse finiture della scrivania, è dotato di pannelli centrali a sportello per avere comodo accesso alle componenti elettriche. Stesso suggestivo abbinamento di finiture per le madie proposte nelle due altezze disponibili, la console in un'unica misura e i tavolini caffè in più dimensioni. Tutti gli elementi della collezione Sessanta arredano con stile gli ambienti di lavoro e allo stesso tempo possono facilmente essere declinati in contesti domestici.

EN— The desk in President plus version is proposed here in the combination with polish Makassar ebony veneer and cappuccino. Prestigious and functional, the meeting table, here proposed with the same finishes as the desk, is equipped with central panels to have easy access to the electrical components. Same suggestive combination of finishes for the sideboards proposed in the two available heights, the console in one size and the coffee tables in several sizes. All the elements of the Sessanta collection furnish the work environments with style and at the same time can easily be declined in domestic contexts.

F— Le bureau de la version President plus est proposé ici en combinant les finitions en bois avec le placage ébène Makassar brillant et cappuccino. Prestigieuse et fonctionnelle, la table de réunion, proposée ici dan les mêmes finitions que le bureau, est équipée de panneaux centraux pour permettre un accès aisé aux composants électriques. Même combinaison suggestive de finitions pour les buffets proposés dans les deux hauteurs disponibles, la console en taille unique et les tables basses en plusieurs tailles. Tous les éléments de la collection Sessanta fournissent un environnement élégant aux environnements de travail, qui peuvent en même temps être facilement déclinés dans les environnements domestiques.



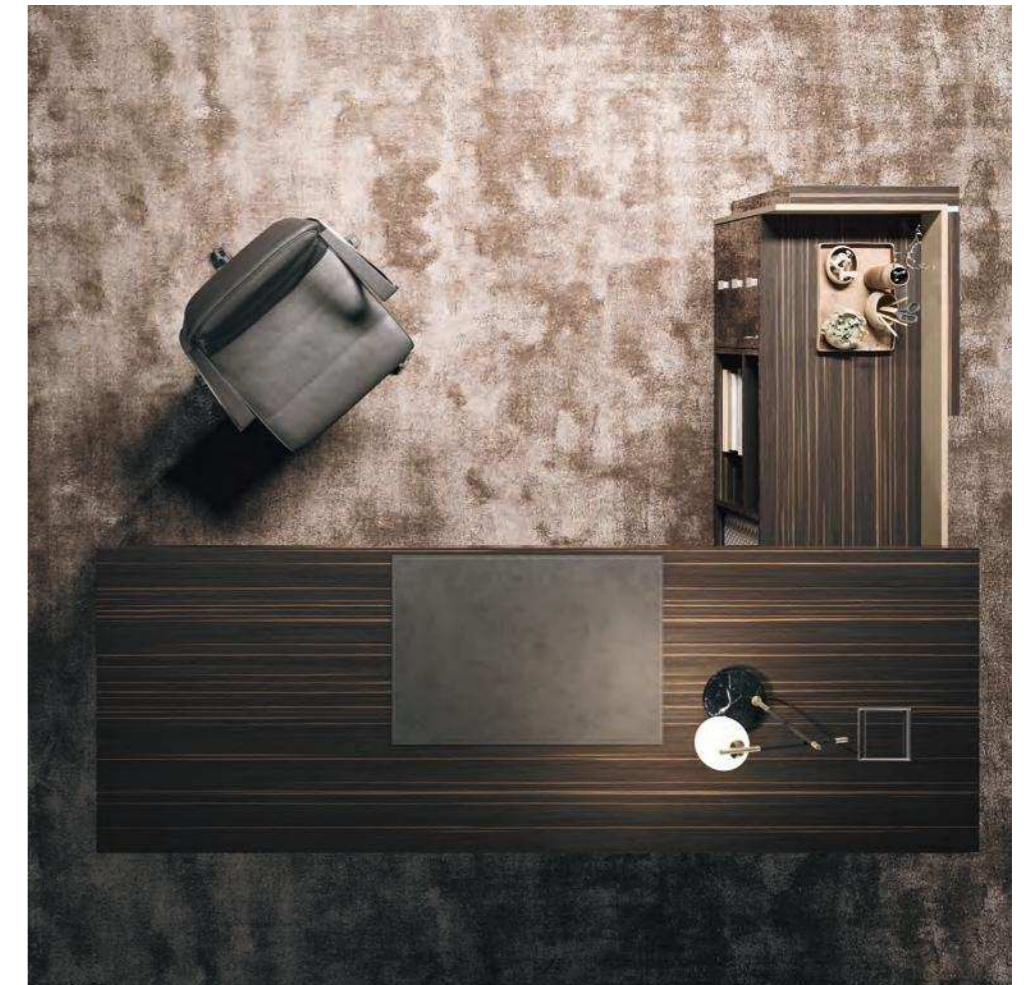

PRESIDENT PLUS DESK — 2600 x 1979 x H 760 mm

VENEER.02



CONSOLE — 1660 x 460 x H 863 mm





SIDEBORD — 1842 x 510 x H 900 mm

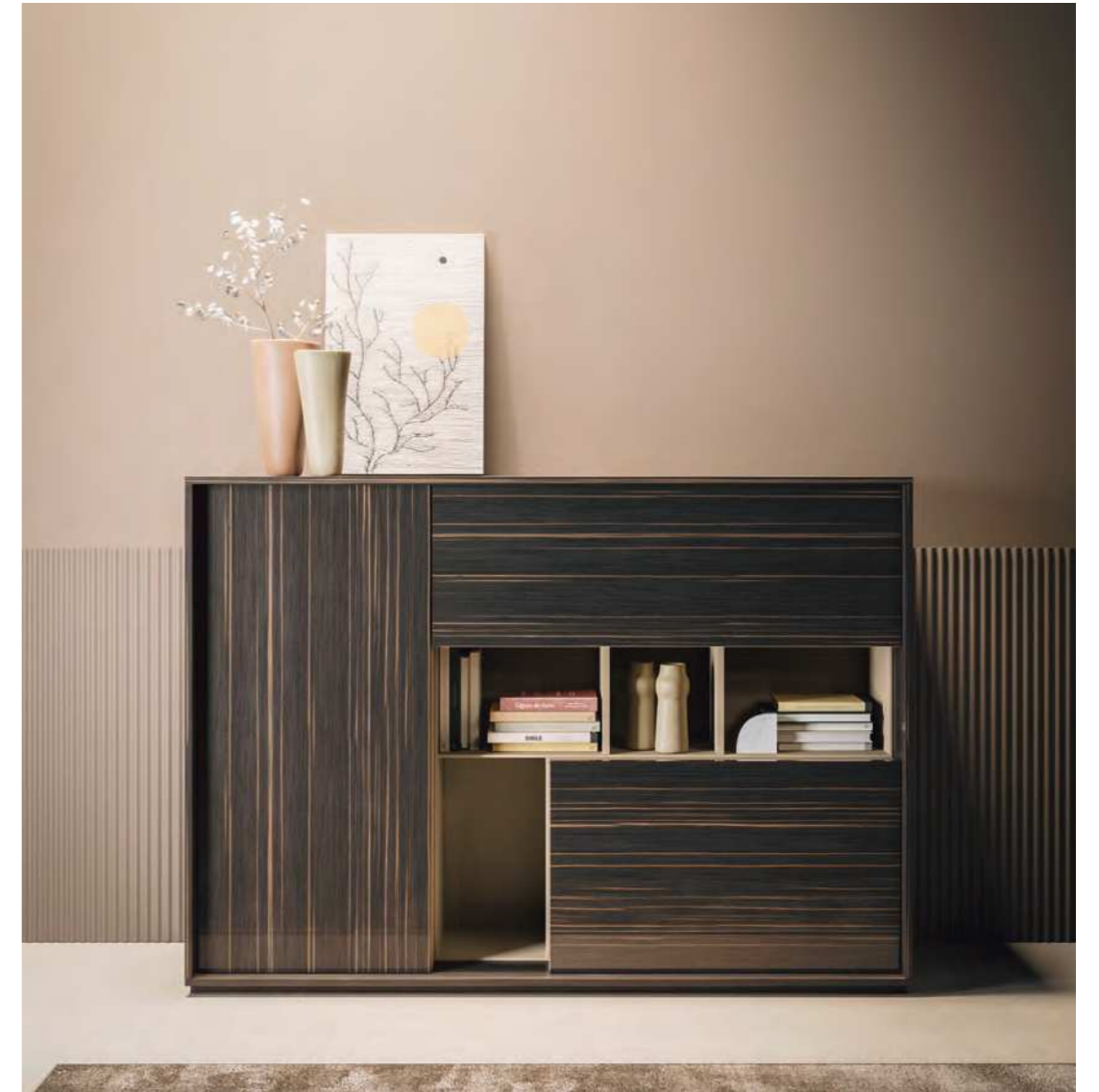

SIDEBORD — 1842 x 510 x H 1316 mm

VENEER 02





MEETING TABLE — 3540 x 1400 x H 760 mm





COFFEE TABLES — 400 x 400 x H 400 mm
800 x 400 x H 400 mm
800 x 800 x H 294 mm

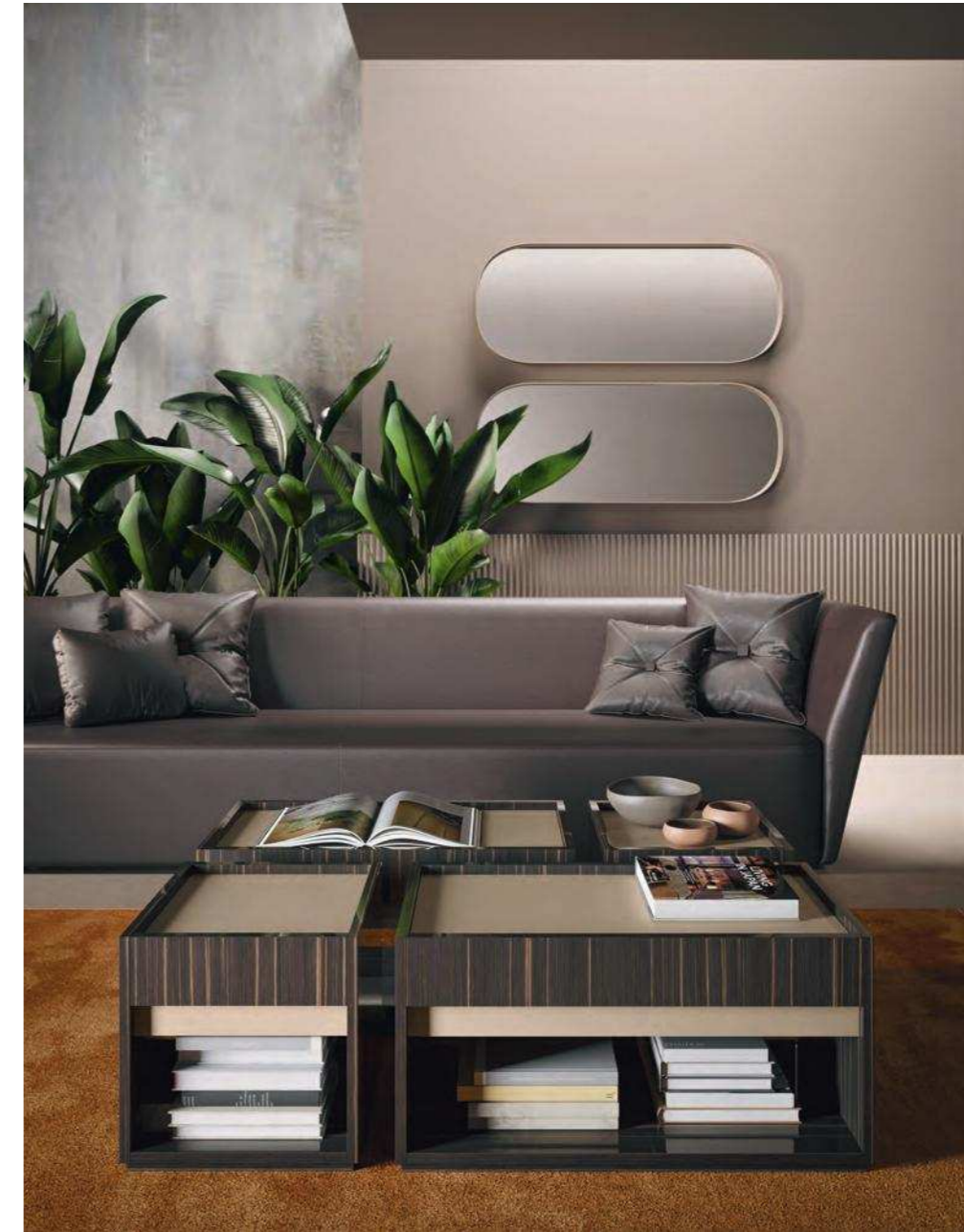



01
FENIX NTM®
FX 0754 blu scuro

02
COLORE MELAMINICO
MC 26 beige

03
COLORE MELAMINICO
MC 31 cipria

01
FENIX NTM®
FX 0754 dark blue

02
MELAMINE COLOR
MC 26 beige

03
MELAMINE COLOR
MC 31 powder

01
FENIX NTM®
FX 0754 bleu foncé

02
COULEUR MÉLAMINÉE
MC 26 beige

03
COULEUR MÉLAMINÉE
MC 31 poudre

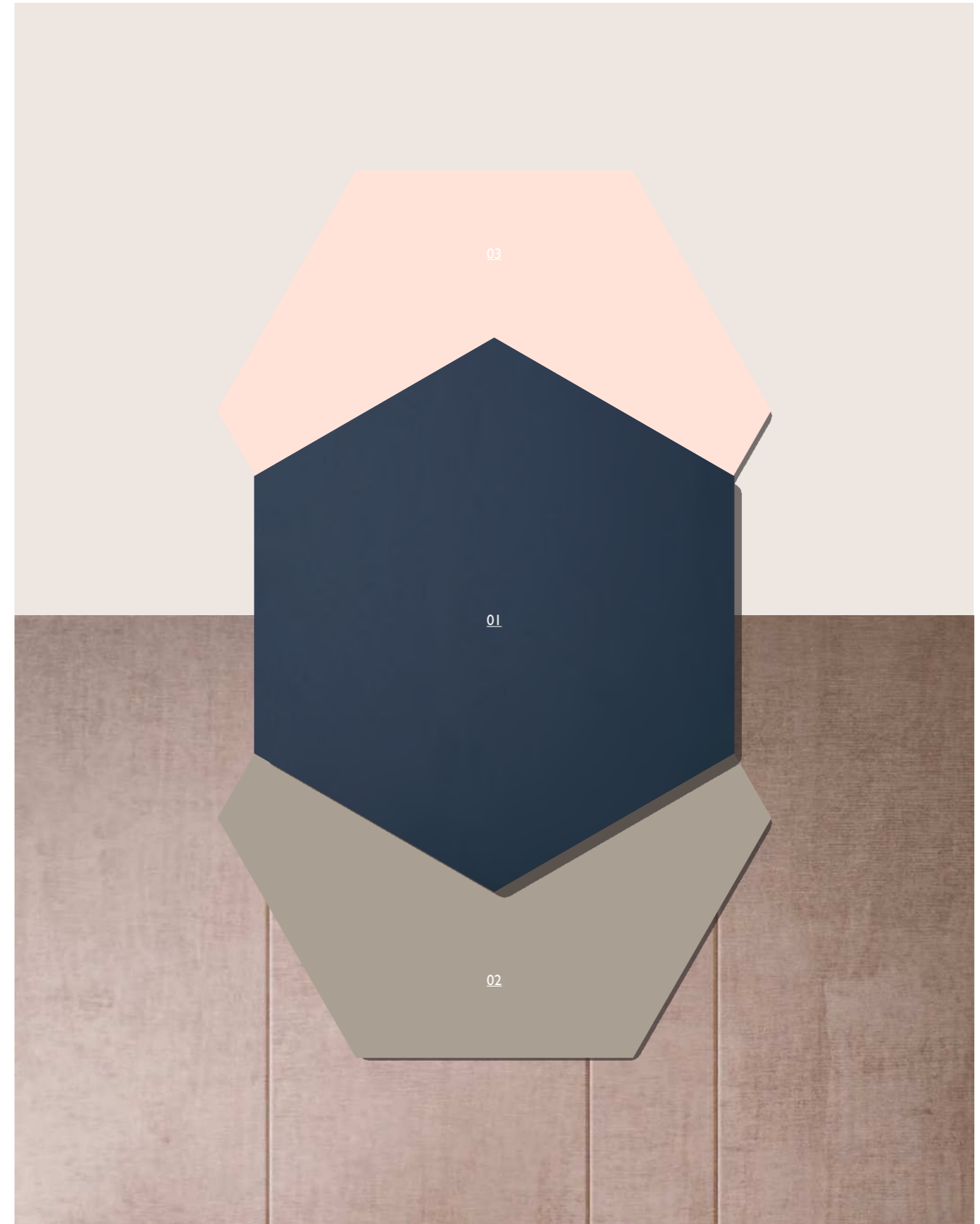

Fenix 01

blu scuro / beige / cipria
 dark blue / beige / powder
 bleu foncé / beige / poudre

IT— Negli accostamenti di colore Fenix NTM® blu scuro e beige melaminico, la scrivania è proposta in versione Executive, che prevede una cassetteria portante canalizzata. Nelle stesse finiture, in un'alternanza di pieni e vuoti, sono presentati la madia media e l'armadio, capaci di unire eleganza formale e grande funzionalità. Nelle immagini successive, protagonista è il tavolo riunione caratterizzato da piani divisi e accostati in un raffinato gioco di geometrie. Centralmente è dotato di fascia ribassata per la canalizzazione, che può essere in tinta con il piano o personalizzata con finiture a contrasto. Lo accompagnano la madia e la consolle nelle finiture blu scuro con inserti nella tonalità cipria.

EN— In the combinations of Fenix NTM® dark blue and melamine beige, the desk is proposed in the Executive version, that provides a cabling supporting drawers unit. In the same finishes, in an alternation of full and empty spaces, the medium sideboard and the storage are presented, capable of combining formal elegance and great functionality. In the following images, the protagonist is the meeting table characterized by divided planes combined in a refined game of geometries. It is centrally equipped with a lowered cabling band, which can be in the same color as the top or customized with contrasting finishes. The matching sideboard and console in the dark blue finish have inserts in powder.

F— Dans les combinaisons de Fenix NTM® bleu foncé et beige mélaminé, le bureau est proposé dans la version Executive, qui comprend un caisson tiroirs canalisé porteur. Dans les mêmes finitions, dans une alternance d'espaces pleins et vides, le bahut moyen et la garde-robe sont présentés, capables de combiner élégance formelle et grande fonctionnalité. Dans les images suivantes, le protagoniste est la table de réunion caractérisée par des plans divisés combinés dans un jeu raffiné de géométries. Il est équipé centralement d'une bande pour canalisation, qui peut être de la même couleur que le plateau ou personnalisé avec des finitions contrastées. Le bahut et la console au fini bleu foncé ont d'inserts en couleur poudre.





EXECUTIVE DESK — 2600 x 900 x H 760 mm

FENIX 01



SIDEBOARD — 1842 x 510 x H 1316 mm



STORAGE — 1842 x 510 x H 2148 mm





MEETING TABLE — 3040 x 1400 x H 760 mm

FENIX 01



CONSOLE — 1660 x 460 x H 863 mm



SIDEBOARD — 1842 x 510 x H 900 mm



- 01**
FENIX NTM®
FX 0720 nero
- 02**
COLORE MELAMINICO
MC 30 basalto
- 03**
COLORE MELAMINICO
MC 24 verde oliva
- 04**
CUIOINETTO RIGENERATO
PC 99 basalto

- 01**
FENIX NTM®
FX 0720 black
- 02**
MELAMINE COLOR
MC 30 basalt
- 03**
MELAMINE COLOR
MC 24 olive green
- 04**
REGENERATED LEATHER
PC 99 basalt

- 01**
FENIX NTM®
FX 0720 noir
- 02**
COULEUR MÉLAMINÉE
MC 30 basalte
- 03**
COULEUR MÉLAMINÉE
MC 24 vert olive
- 04**
CUIR RECONSTITUÉ
PC 99 basalte

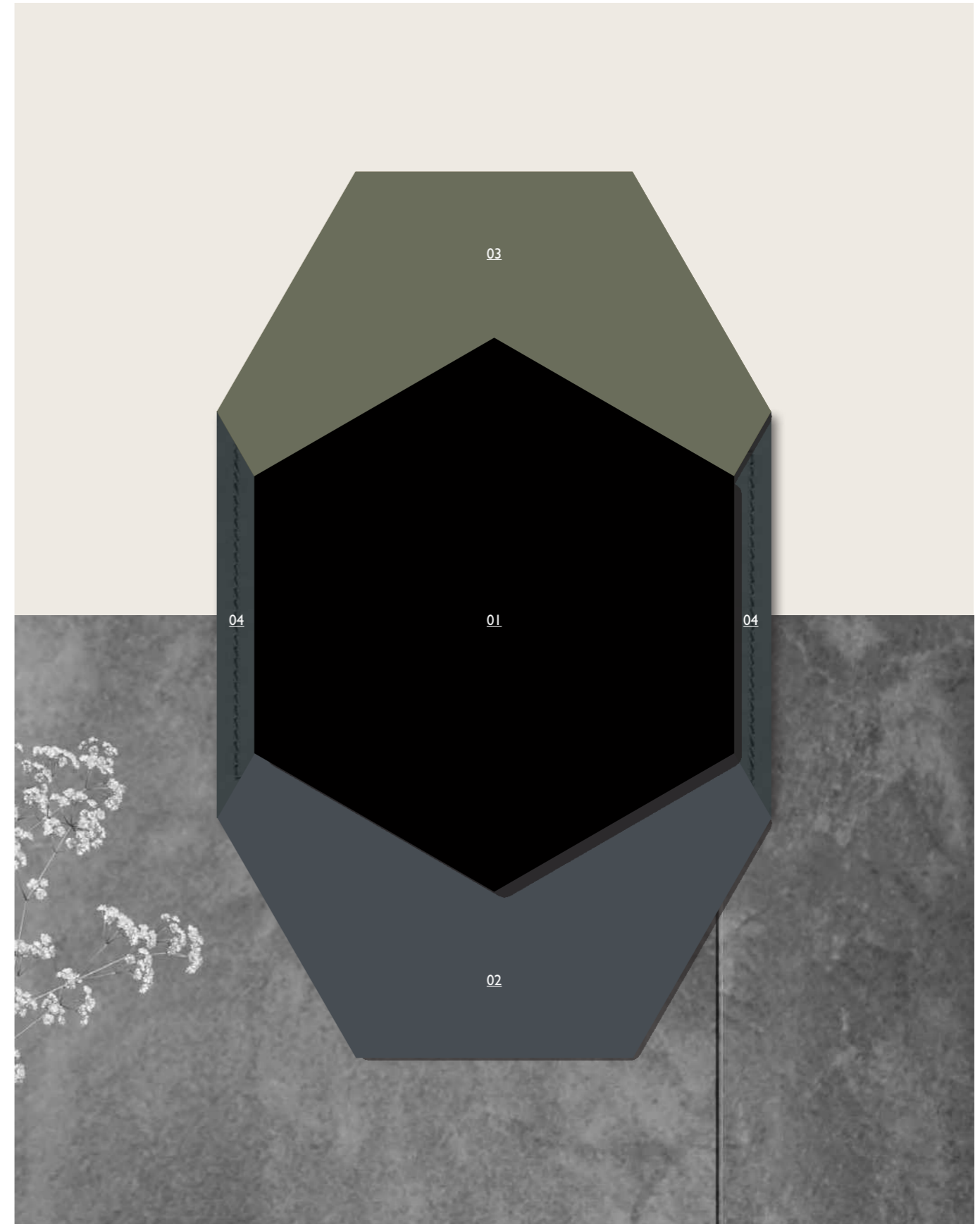

Fenix 02

nero / basalto / verde oliva
black / basalt / olive green
noir / basalte / vert olive

IT— Equilibrio di volumi ed essenzialità delle forme, per la scrivania nella variante Executive proposta in Fenix NTM® nero con gonna rivestita in cuoietto rigenerato color basalto arricchito da cuciture a vista. Abbinati i mobili contenitori nelle tre tonalità nero, verde oliva e basalto. Hanno moduli a giorno e vani chiusi da ante con apertura push to open: a sinistra anta unica a battente con ripiani in vetro, in alto a destra anta a ribalta. In basso a destra, un cestone con comodo cassetto interno ad estrazione totale e chiusura ammortizzata. Suggestioni materiche per il tavolo rotondo nero con base metallica e piano in spessore 60 mm rivestito in cuoietto rigenerato con cuciture. Grande versatilità compositiva per i tavolini caffè quadrati e rettangolari presentati nelle tonalità nero, verde oliva e basalto. La consolle è caratterizzata da cassetti di forte spessore rivestiti in cuoietto rigenerato color basalto e impreziositi da cuciture tono su tono.

EN— Balance of volumes and essentiality of forms, for the desk in the Executive variant proposed in Fenix NTM® black with modesty panel covered in basalt-colored regenerated leather enriched with visible stitching. Combined with the cabinets in the three shades black, olive green and basalt. They have open modules and compartments closed by doors with push to open opening: on the left, single hinged door with glass shelves, on the upper right flap door. Lower right, a filing drawer with a comfortable total extraction and soft closing internal drawer. Material suggestions for the black round table with metal base and top in 60 mm thick regenerated leather covered with stitching. Great compositional versatility for the square and rectangular coffee tables presented in black, olive green and basalt shades. The console is characterized by thick drawers covered in basalt-colored regenerated leather and embellished with tone-on-tone stitching.

F— Équilibre entre volumes et caractère essentiel des formes, pour le bureau de la variante de bureau Executive proposé en Fenix NTM® noir avec voile de fond revêtue de cuir reconstitué couleur basalte enrichi de surpiqûres apparentes. Combiné avec les armoires dans les trois teintes noir, vert olive et basalte. Ils ont des modules ouverts et des compartiments fermés par des portes avec ouverture à poussée: à gauche, une seule porte à charnière avec tablettes en verre, une porte supérieure droite à rabat. En bas à droite, un tiroir de classement avec un tiroir interne confortable à extension complète et à fermeture en douceur. Suggestions de matériaux pour la table ronde noire avec base en métal et plateau en cuir reconstitué épais de 60 mm recouvert de surpiqûres. Grande polyvalence de composition pour les tables basses carrées et rectangulaires présentées dans les tons noir, vert olive et basalte. La console est caractérisée par des tiroirs épais recouverts de cuir reconstitué de couleur basalte et ornés de coutures ton sur ton.





EXECUTIVE DESK — 2600 x 900 x H 760 mm



SIDEBOARD — 1842 x 510 x H 1316 mm



COFFEE TABLES — 800 x 400 x H 400 mm
800 x 800 x H 294 mm



CONSOLE — 1660 x 460 x H 863 mm





SIDEBOARD — 1842 x 510 x H 900 mm



MEETING TABLE — Ø 1400 x H 760 mm

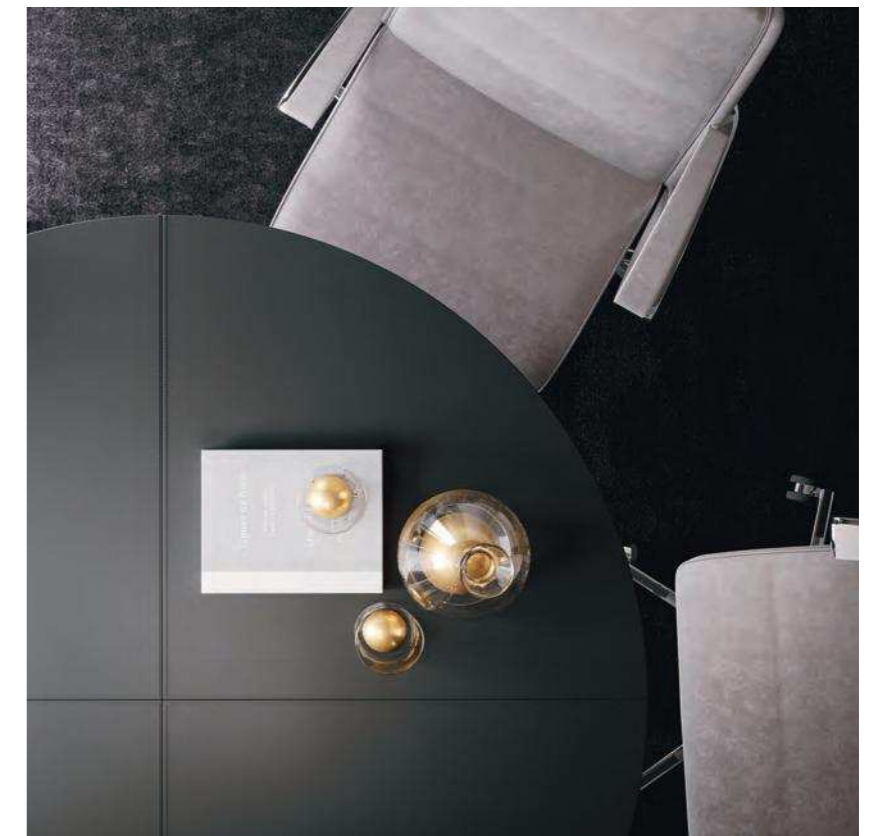



01
FENIX NTM®
FX 0032 bianco

02
COLORE MELAMINICO
MC 34 grigio perla

01
FENIX NTM®
FX 0032 white

02
MELAMINE COLOR
MC 34 pearl grey

01
FENIX NTM®
FX 0032 blanc

02
COULEUR MÉLAMINÉE
MC 34 gris perle

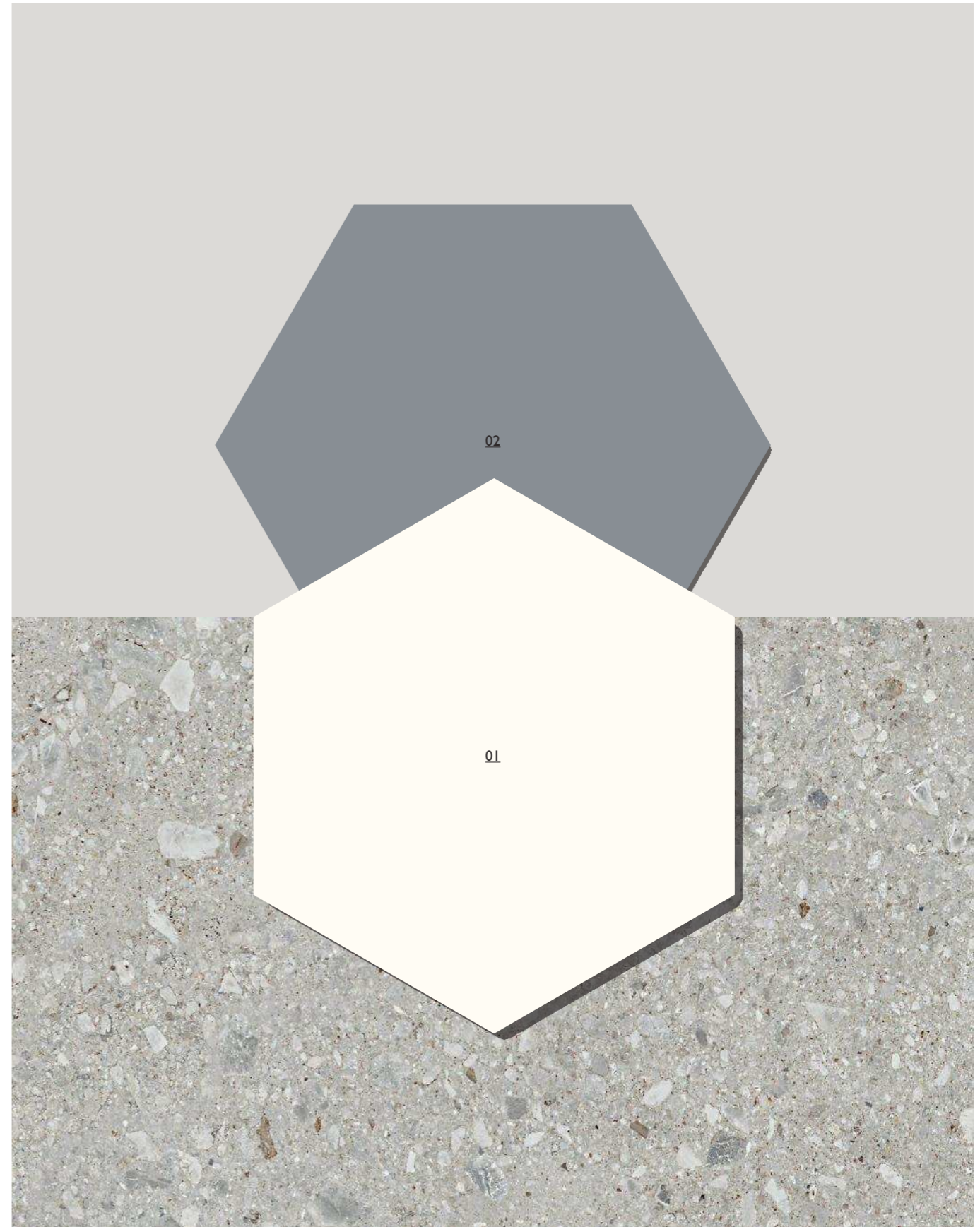

Fenix 03

bianco / grigio perla
white / pearl grey
blanc / gris perle

IT— Con elegante semplicità, la scrivania è proposta nella variante Manager, caratterizzata dal piano e dalla struttura in spessore 60 mm. In aggiunta, il dattilo e la cassettera su ruote dotata di vassoio porta oggetti. Con il mobile contenitore abbinato, è presentata nelle finiture bianco e grigio perla. Negli stessi colori, il tavolo meeting che coniuga essenzialità e funzionalità. Abbinato con vani a giorno in grigio perla, l'armadio è caratterizzato da un cestone con cassetto interno e da ante a battenti che racchiudono moduli con ripiani in vetro. Nelle tre dimensioni previste, i tavolini caffè dalle linee rigorose, valorizzate dai contrasti di finiture, qui giocati nelle tonalità bianco e grigio perla.

EN— With elegant simplicity, the desk is proposed in the Manager variant, characterized by 60 mm thick top and structure. In addition, the extension and pedestal drawers unit on castors equipped with a glove compartment. With the matching cabinet, it is presented in white and pearl grey finishes. In the same colors, the meeting table that combines essentiality and functionality. Combined with open compartments in pearl grey, the storage is characterized by a filing drawer with an internal drawer and hinged doors that enclose modules with glass shelves. In the three dimensions provided, the coffee tables with rigorous lines, enhanced by the contrasts of finishes played here in white and pearl grey shades.

F— D'une simplicité élégante, le bureau est proposé dans la variante Manager, caractérisée par le plateau et le structure de 60 mm d'épaisseur. En outre, le retour et le caisson tiroirs sur roulettes équipée d'un plateau pour ranger des objets. Avec l'unité de rangement correspondante, il est présenté dans les finitions blanches et gris perle. Dans les mêmes couleurs, la table de réunion allie caractère essentiel et fonctionnalité. Combinée à des compartiments ouverts en mélaminé gris perle, la garde-robe se caractérise par un caisson avec un tiroir interne et des portes à charnières qui enferment des modules avec des étagères en verre. Dans les trois dimensions fournies, les tables basses aux lignes rigoureuses, accentuées par les contrastes de finitions jouées ici dans les tons blanc et gris perle.





MANAGER DESK — 2200 x 1900 x H 760 mm



SIDEBOARD — 1842 x 510 x H 1316 mm





MEETING TABLE — 3040 x 1400 x H 760 mm



STORAGE — 1842 x 510 x H 2148 mm



COFFEE TABLES — 400 x 400 x H 404 mm
800 x 400 x H 404 mm
800 x 800 x H 294 mm

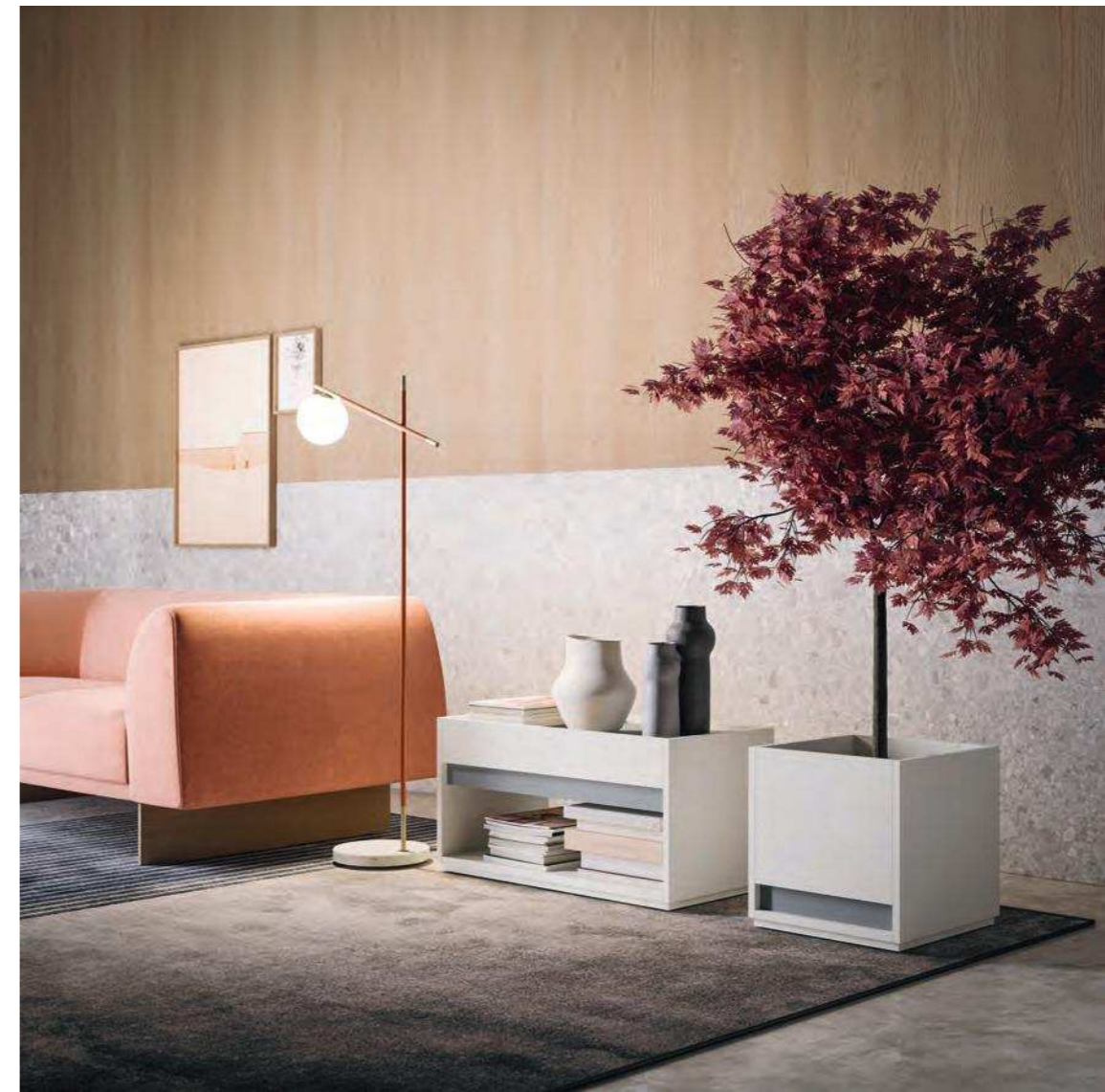

MELAMINE
01

01
MELAMINICO
ME 75 noce natural

02
COLORE MELAMINICO
MC 26 beige

01
MELAMINE
ME 75 natural walnut

02
MELAMINE COLOR
MC 26 beige

01
MÉLAMINÉE
ME 75 noyer naturelle

02
COULEUR MÉLAMINÉE
MC 26 beige

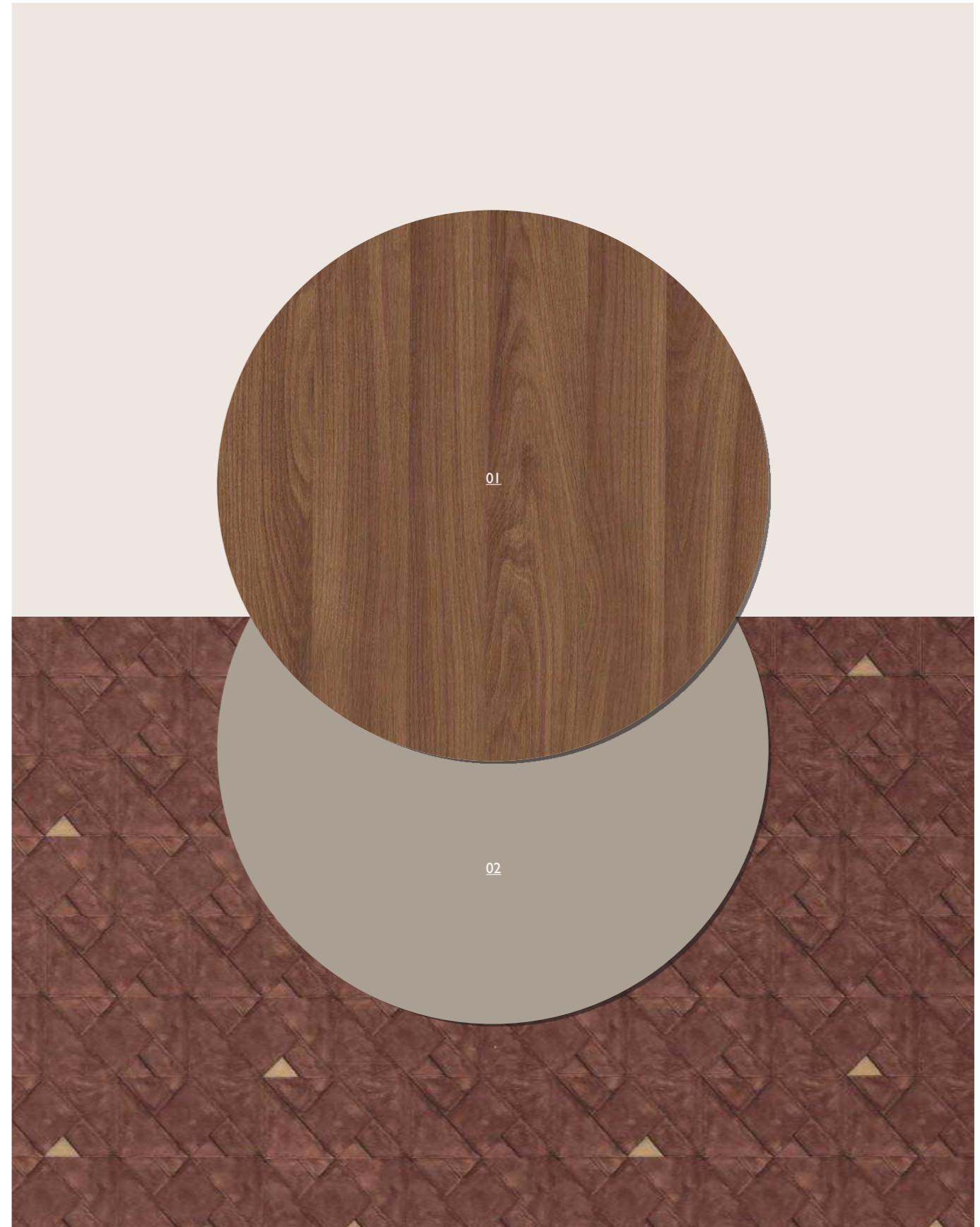

Melamine 01

noce natural / beige
 natural walnut / beige
 noyer naturelle / beige

IT— In connubio tra funzionalità ed eleganza, la scrivania è proposta in versione Executive nelle finiture melaminiche noce natural e beige. Nelle stesse tonalità, le madie nelle due altezze e l'armadio sono caratterizzati da geometrie essenziali e volumi puri, enfatizzati dall'assenza di maniglie. Il tavolo rotondo, perfetto per piccole riunioni, ha un piano in spessore con caratteristico incrocio delle venature ed è ora disponibile in più dimensioni. Qui presentato in versione noce natural con base metallica color castoro. La consolle in finitura noce natural e ravvivata da inserti in beige, è disponibile in unica misura ed è dotata di due cassetti con apertura push to open. Pensati per ambienti di lavoro ma perfetti anche in contesti domestici, i tavolini caffè sono disponibili in diverse dimensioni di forma quadrata e rettangolare e possono essere disposti in modo indipendente o integrato con i sistemi seduta.

EN— In union between functionality and elegance, the desk is proposed in the Executive version in natural walnut and beige melamine finishes. In the same shades, the cupboards in the two heights and the storage are characterized by essential geometries and pure volumes, emphasized by the absence of handles. The round table, perfect for small meetings, has a thick top with a characteristic vein intersection and is now available in several sizes. Here presented in a natural walnut version with a beaver-colored metal base. The console in natural walnut finish and brightened by beige inserts, is available in one size only and is equipped with two drawers with push to open opening. Designed for working environments but also perfect in domestic contexts, the coffee tables are available in different sizes, square and rectangular, and can be arranged independently or integrated with the seating systems.

F— En union entre fonctionnalité et élégance, le bureau est proposé dans la version Executive en finitions noyer naturelle et mélaminé beige. Dans les mêmes nuances, les bahuts des deux hauteurs et l'armoire caractérisent par des géométries essentielles et des volumes purs, soulignés par l'absence de poignées. La table ronde, idéale pour les petites réunions, a un plateau épais avec une intersection de veine caractéristique et est maintenant disponible en plusieurs tailles. Ici présenté dans une version en noyer naturelle avec une base en métal de couleur castor. La console en finition noyer naturelle et agrémentée d'inserts beiges est disponible en une seule taille et est équipée de deux tiroirs avec ouverture à pousser. Conçues pour les environnements de travail mais également parfaites pour les environnements domestiques, les tables basses sont disponibles en différentes tailles, carrées et rectangulaires, et peuvent être agencées indépendamment ou intégrées aux systèmes de sièges.





PRESIDENT DESK — 2600 x 1979 x H 760 mm

MELAMINE 01



SIDEBOARD — 1842 x 510 x H 1316 mm



SIDEBOARD — 1842 x 510 x H 900 mm



MEETING TABLE — Ø 1400 x H 760 mm

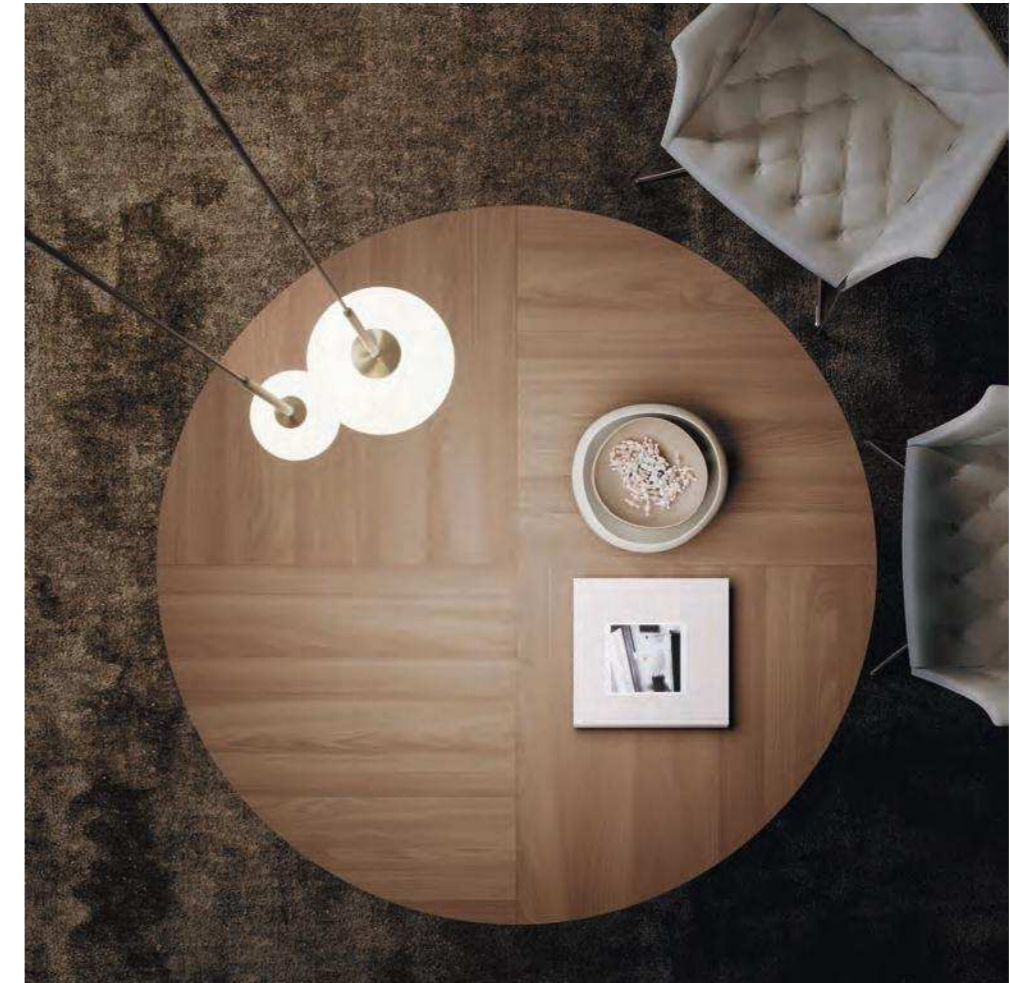



CONSOLE — 1660 x 460 x H 863 mm

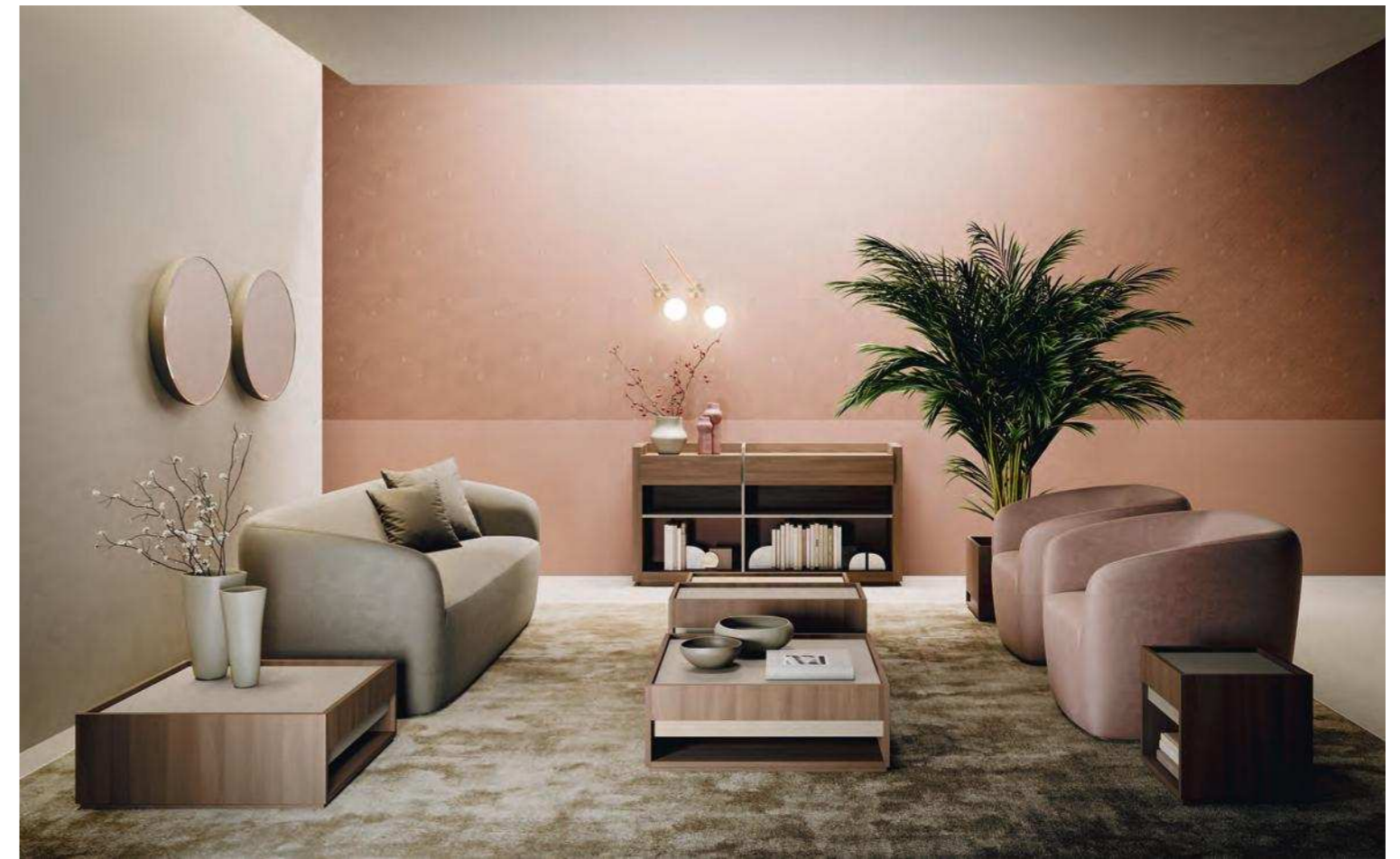

COFFEE TABLES — 400 x 400 x H 400 mm
800 x 400 x H 400 mm
800 x 800 x H 294 mm

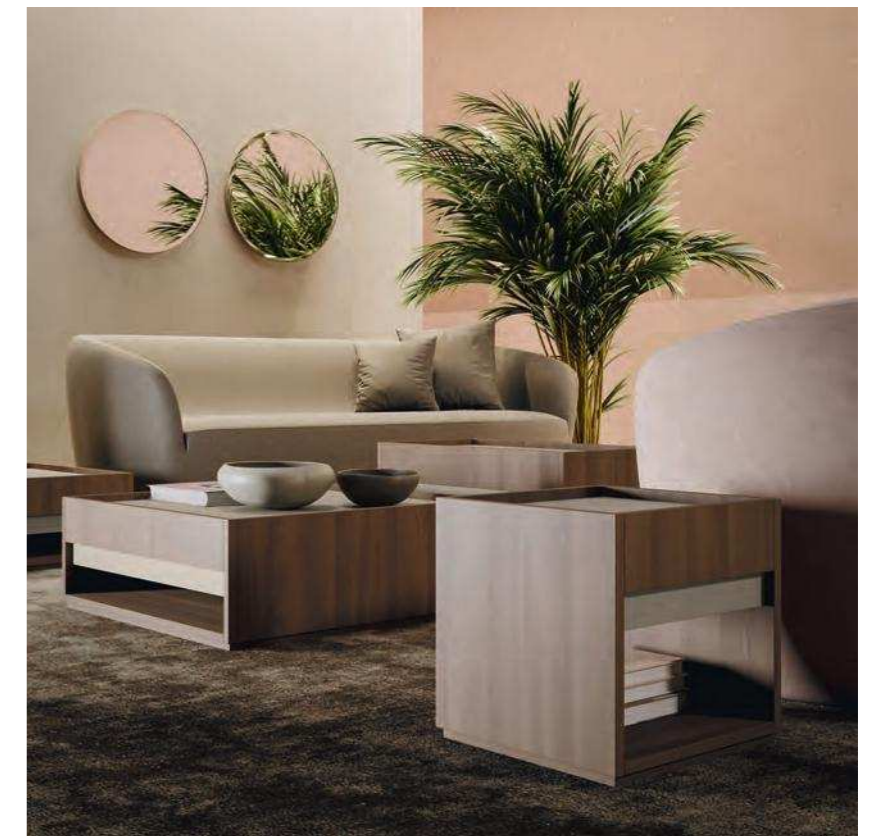



« TECHNICALS »

IM - IMPIALLACCIATO LEGNO / WOOD VENEER / PLAQUÉ BOIS

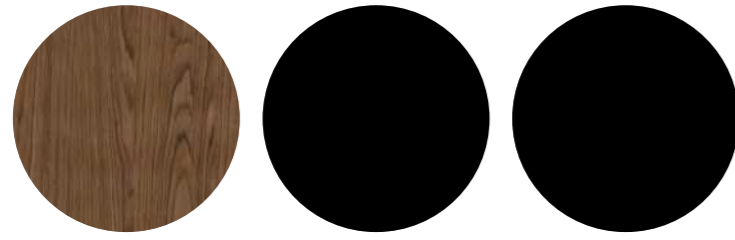

44
noce Canaletto
walnut Canaletto
noyer Canaletto

50
rovere termotrattato
thermotreated oak
chêne traité thermiquement

48
ebano Makassar lucido 100 gloss
ebony Makassar 100 gloss polish
ébène Makassar 100 brillant

FX - FENIX NTM® / FENIX NTM® / FENIX NTM®

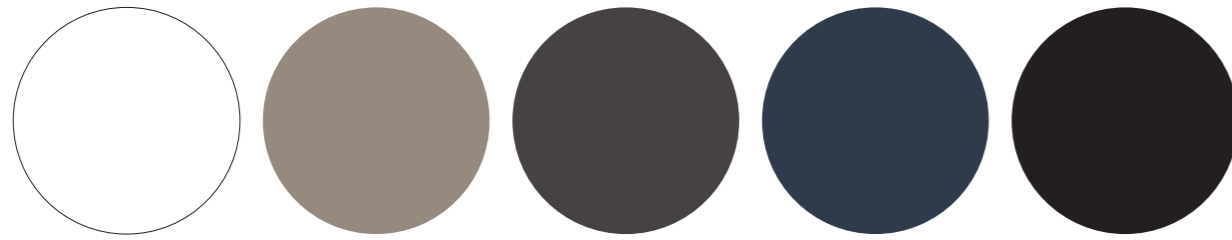

0032
bianco
white
blanc

0717
castoro
beaver
castor

0749
cacao
cocoa
cacao

0754
blu scuro
dark blue
bleu foncé

0720
nero
black
noir

ME - MELAMINICO / MELAMINE / MÉLAMINÉ



70
olmo
elm
orme

75
noce natural
natural walnut
noyer naturelle

77
noce dark
dark walnut
noyer foncé



20
bianco
white
blanc

01
grigio chiaro
light grey
gris clair

04
nero
black
noir

MC - COLORE MELAMINICO / MELAMINE COLOR / COULEUR MÉLAMINÉE

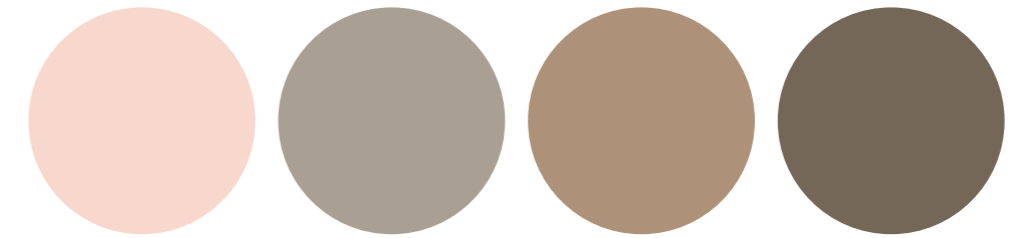

31
cipria
powder
poudre

26
beige
beige
beige

23
cappuccino
cappuccino
cappuccino

25
tabacco
tobacco
tabac

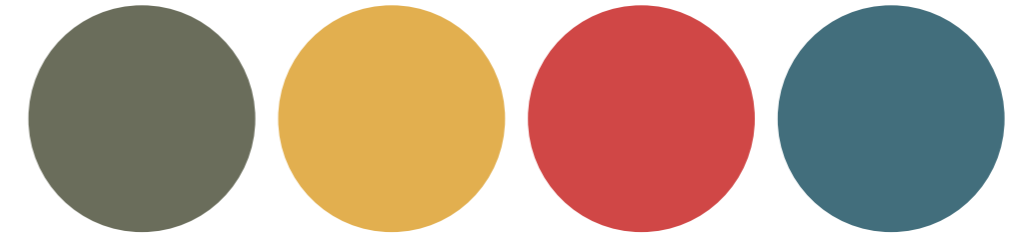

24
verde oliva
olive green
vert olive

32
curry
curry
curry

29
rosso oriente
orient red
rouge orient

33
petrolio
petroleum
pétrole



34
grigio perla
pearl grey
gris perle

30
basalto
basalt
basalte

35
blu sea
blue sea
mer bleue

MO1 - METALLO VERNICIATO OPACO / MATT VARNISHED METAL / MÉTAL VERNI MAT

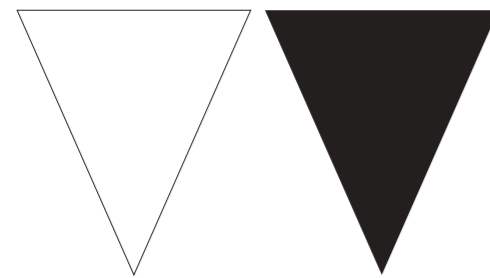

9010
bianco
white
blanc

9005
nero
black
noir

MO2 - METALLO VERNICIATO OPACO / MATT VARNISHED METAL / MÉTAL VERNI MAT



7047
grigio chiaro
light grey
gris clair

7045
grigio perla
pearl grey
gris perle

7011
basalto
basalt
basalte

5011
blu scuro
dark blue
bleu foncé

5020
petrolio
petroleum
pétrole



1019
cappuccino
cappuccino
cappuccino

7048
castoro
beaver
castor

7003
verde oliva
olive green
vert olive

8019
cacao
cocoa
cacao

1036
ottone
brass
laiton



1032
curry
curry
curry

3012
rame
copper
cuivre

3031
rosso oriente
orient red
rouge orient

3004
rosso rubino
ruby red
rouge rubis

PC - CUOINETTO RIGENERATO / REGENERATED LEATHER / CUIR RECONSTITUÉ



90
bianco
white
blanc

98
cuoio
cuoio
cuir

96
testa di moro
dark brown
brun foncé

99
basalto
basalt
basalte

92
nero
black
noir

SCRIVANIA MANAGER
MANAGER DESK
BUREAU MANAGER

IT— Scrivania con piano e gambe sp 60 mm e gonna sp 18/19 mm. La scrivania può essere accompagnata da un dattilo.

EN— Desk with 60 mm thick top and legs and 18/19 mm thick modesty panel. The desk can be equipped with a work extension.

F— Bureau avec plateau et pieds de 60 mm d'épaisseur et voile de fond de 18/19 mm d'épaisseur. Le bureau peut être accompagné d'un retour.

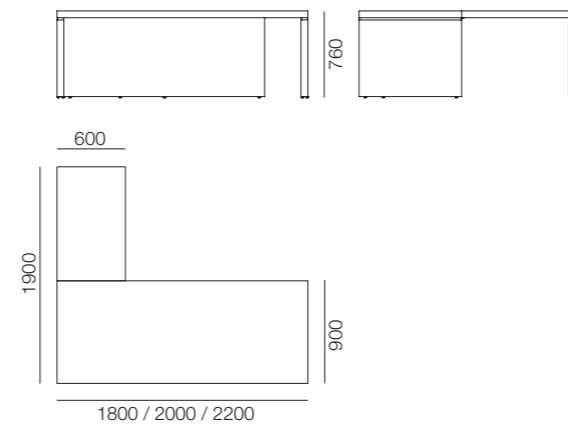

EXECUTIVE



SCRIVANIA EXECUTIVE / EXECUTIVE PLUS
EXECUTIVE / EXECUTIVE PLUS DESK
BUREAU EXECUTIVE / EXECUTIVE PLUS

IT— Scrivania con piano e gamba sp 60 mm, gonna sp 18/19 mm e cassetiera portante.
 La versione Executive plus si distingue per il piano a tutta lunghezza.

EN— Desk with 60 mm thick top and leg, 18/19 mm thick modesty panel and pedestal drawers unit.
 The Executive plus version stands out for its full-length top.

F— Bureau avec plateau et piétement de 60 mm d'épaisseur, voile de fond épaisseur de 18/19 mm et tiroir de soutien.
 La version Executive plus se distingue par le plateau sur toute la longueur.

EXECUTIVE



EXECUTIVE



EXECUTIVE PLUS

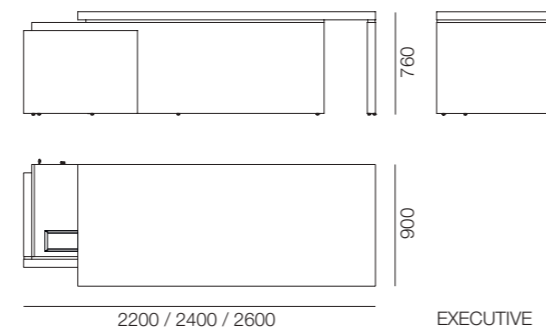

EXECUTIVE

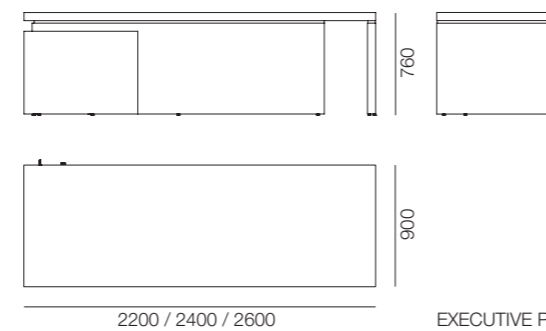

EXECUTIVE PLUS

EXECUTIVE PLUS



EXECUTIVE PLUS



PRESIDENT



SCRIVANIA PRESIDENT / PRESIDENT PLUS
PRESIDENT / PRESIDENT PLUS DESK
BUREAU PRESIDENT / PRESIDENT PLUS

IT— Scrivania con piano e gamba sp 60 mm, gonna sp 18/19 mm e mobile portante dotato di vani a giorno e cassettera.
 La versione President plus si distingue per il piano a tutta lunghezza.

EN— Desk with 60 mm thick folding top and leg and with 18/19 mm thick modesty panel. It is equipped with a supporting cabinet with open compartments and pedestal drawers unit.
 The President plus version stands out for its full-length top.

F— Bureau avec plateau et piétement 60 mm d'épaisseur, voile de fond de 18/19 mm d'épaisseur et meuble de support à compartiments ouverts et caisson tiroirs.
 La version Président plus se distingue par le plateau sur toute la longueur.

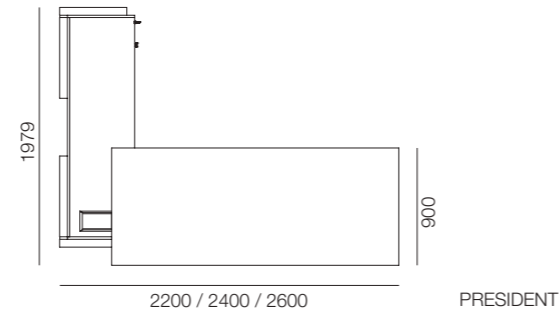
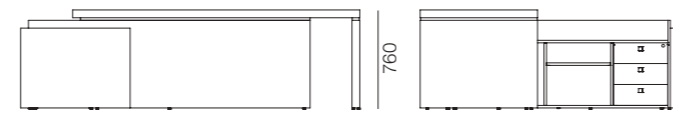

PRESIDENT

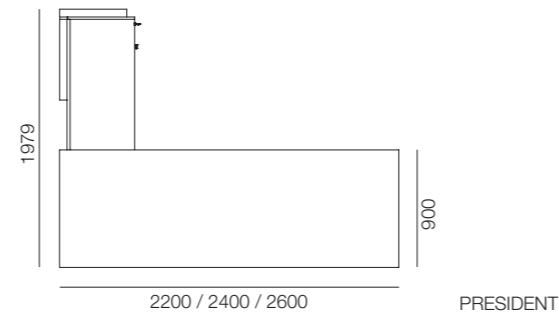
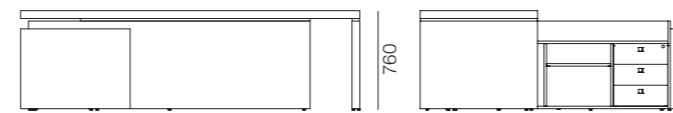

PRESIDENT PLUS

PRESIDENT



PRESIDENT



PRESIDENT PLUS



PRESIDENT PLUS



PRESIDENT PLUS



CANALIZZAZIONE SCRIVANIE
DESKS CABLING SYSTEM
CANALISATION BUREAUX

IT— Le scrivanie, fatta eccezione per la versione Manager per cui è opzionale, prevedono di serie un passacavo Profcable in alluminio anodizzato, con sportello apribile in tinta con il piano. È prevista come optional anche la possibilità di installare un caricatore wireless a scomparsa totale nel piano.

EN— The desks, except for the Manager version for which it is optional, include an anodized aluminum Profcable cable tidy as standard, with an openable door in the same color as the top. As optional, it can be also equipped with under top wireless charger.

F— Les bureaux, à l'exception de la version Manager pour laquelle il est facultatif, incluent en standard un passe-câble Profcable en aluminium anodisé, avec une porte qui s'ouvre de la même couleur que le plateau. La possibilité d'installer un chargeur sans fil entièrement dissimulé dans le plateau est également facultative.

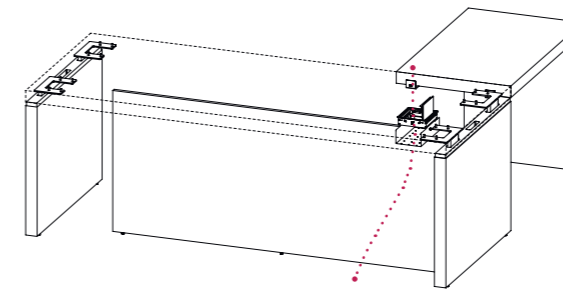

MANAGER
 passacavo optional
 optional cable tidy
 passe-câble facultative

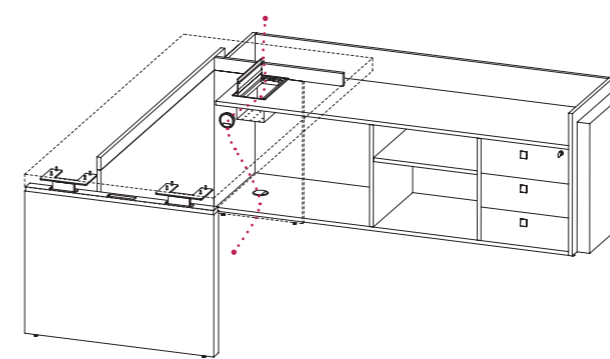

EXECUTIVE

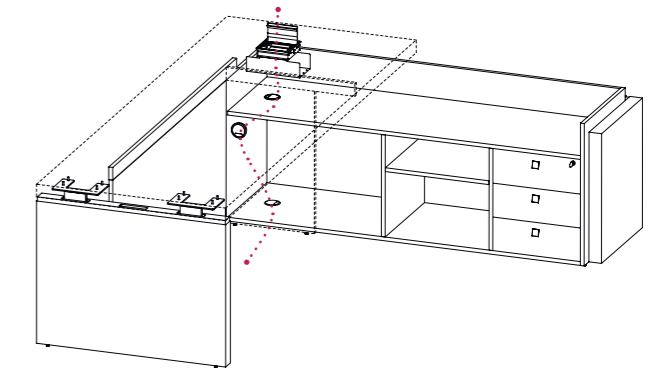

EXECUTIVE PLUS

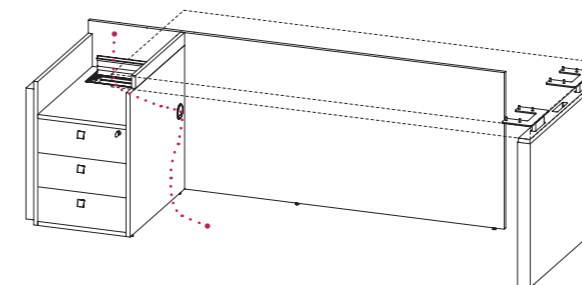

PRESIDENT

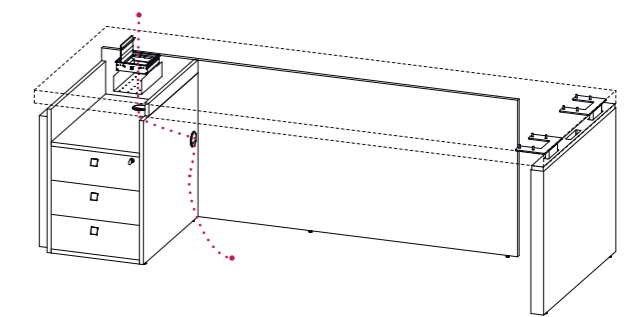

PRESIDENT PLUS



CASSETTIERA SU RUOTE
PEDESTAL DRAWERS UNIT ON CASTORS
CAISSON TIROIRS SUR ROULETTES

- IT**— Cassettiera su ruote con tre cassetti e serratura.
- EN**— Pedestal three drawers unit on castors with lock.
- F**— Caisson tiroirs sur roulettes avec trois tiroirs et serrure.

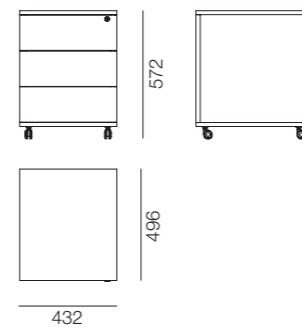

CASSETTIERA SU RUOTE
PEDESTAL DRAWERS UNIT ON CASTORS
CAISSON TIROIRS SUR ROULETTES

- IT**— Cassettiera su ruote con due cassetti, serratura e vassoio porta oggetti.
- EN**— Pedestal two drawers unit on castors with lock and glove compartment.
- F**— Caisson tiroirs sur roulettes avec deux tiroirs, serrure et plateau pour objets.

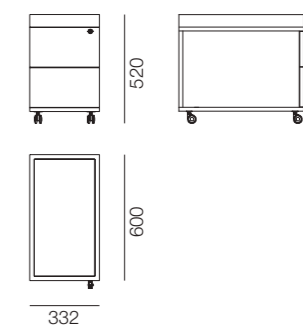

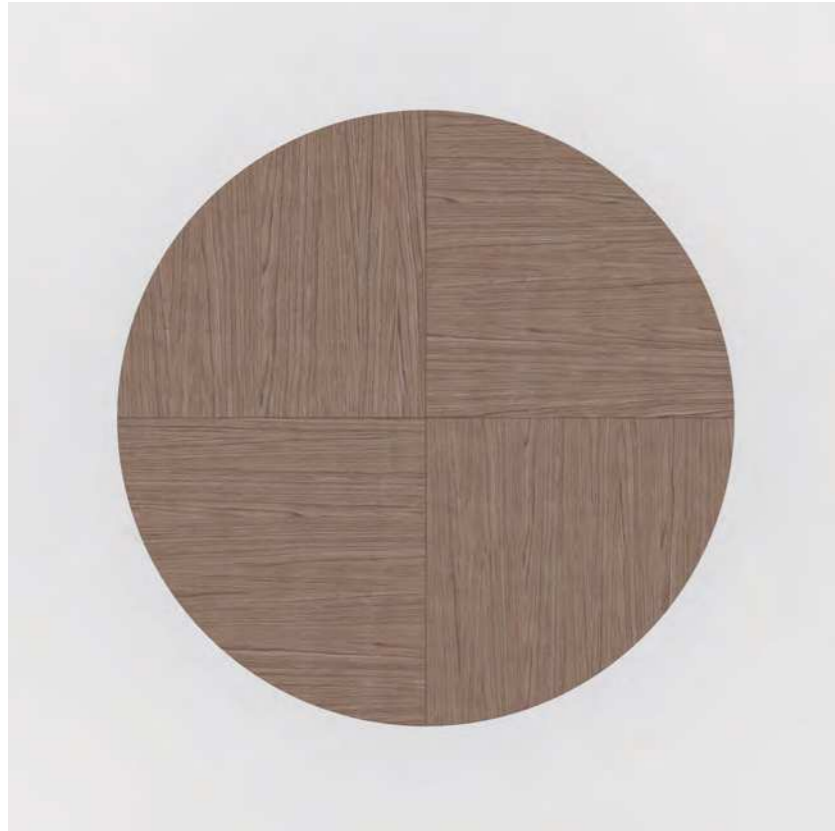

TAVOLO RIUNIONE ROTONDO
ROUND MEETING TABLE
TABLE DE RÉUNION RONDE

IT— Tavolo riunione rotondo con piano sp 60 mm, composto da piani accostati, che nella versione in legno, hanno un caratteristico incrocio delle venature. La base del tavolo è in tubolare metallico con piastre superiori e inferiori verniciate opache.

EN— Round meeting table with 60 mm thick top, composed by drawn near tops, that in the wood version, have a distinctive cross veins. It has a tubular metal base with the upper and lower plates painted with matte finish.

F— Table de réunion ronde avec plateau 60 mm d'épaisseur, composée de plans combinés, qui dans la version en bois présentent une croix caractéristique des nervures. La base de la table est en métal tubulaire avec des plateaux supérieurs et inférieurs opaques.

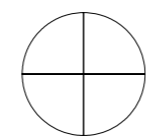
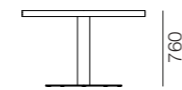

1000 / 1200 / 1400



TAVOLO RIUNIONE EASY
EASY MEETING TABLE
TABLE DE RÉUNION EASY

IT— Tavolo riunione con piano unico e gambe sp 60 mm e gonna sp 18/19 mm. È dotato di passacavo rettangolare Proficable in alluminio anodizzato con sportello apribile in tinta con il piano.

EN— Meeting table with 60 mm thick one top and legs and 18/19 mm thick modesty panel. It is equipped with a rectangular anodized aluminum Proficable cable tidy with an openable door in the same color as the top.

F— Table de réunion avec plateau simple et pieds de 60 mm d'épaisseur et voile de fond de 18/19 mm d'épaisseur. Il est équipé d'un passe-câble rectangulaire Proficable en aluminium anodisé avec une porte pouvant s'ouvrir de la même couleur que le plateau.

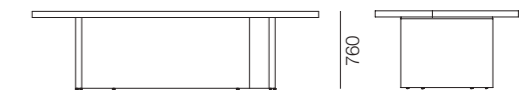

2200 / 2400 / 2800

TAVOLO RIUNIONE
MEETING TABLE
TABLE DE RÉUNION

IT— Tavolo riunione con piano e gambe in sp 60 mm e gonna sp 18/19 mm. Il top è composto da piani accostati, che nella versione in legno, hanno un caratteristico incrocio delle venature. La fascia centrale ribassata per la canalizzazione può avere una finitura in tinta o in contrasto con il piano.

EN— Meeting table with 60 mm thick top and legs and 18/19 mm thick modesty panel. The top is composed by drawn near tops, that in the wood version, have a distinctive cross veins. The central lowered band for cable management can be in matching or opposite finish with the top.

F— Table de réunion avec plateau et pieds de 60 mm d'épaisseur et voile de fond de 18/19 mm d'épaisseur. Le plateau est composé de plateaux juxtaposés qui, dans la version en bois, présentent une intersection veineuse caractéristique. La bande centrale abaissée pour canalisation peut avoir une finition qui correspond ou contraste avec le plateau.

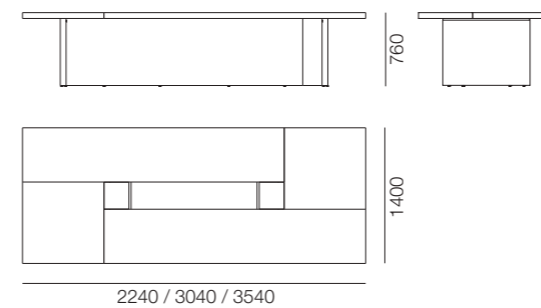

TAVOLO RIUNIONE MODULARE
MODULAR MEETING TABLE
TABLE DE RÉUNION MODULAIRE

IT— Tavolo riunione con piani componibili e gambe sp 60 mm e gonne sp 18/19 mm. Il top è composto da piani accostati, che nella versione in legno, hanno un caratteristico incrocio delle venature. La fascia centrale ribassata per la canalizzazione può avere una finitura in tinta o in contrasto con il piano.

EN— Meeting table with 60 mm thick modular tops and legs and 18/19 mm thick modesty panels. The top is composed by drawn near tops, that in the wood version, have a distinctive cross veins. The central lowered band for cable management can be in matching or opposite finish with the top.

F— Table de réunion avec plateaux et pieds modulaires, voile de fond de 60 mm d'épaisseur et 18/19 mm d'épaisseur. Le plateau est composé de plateaux juxtaposés qui, dans la version en bois, présentent une intersection veineuse caractéristique. La bande centrale abaissée pour canalisation peut avoir une finition qui correspond ou contraste avec le plateau.

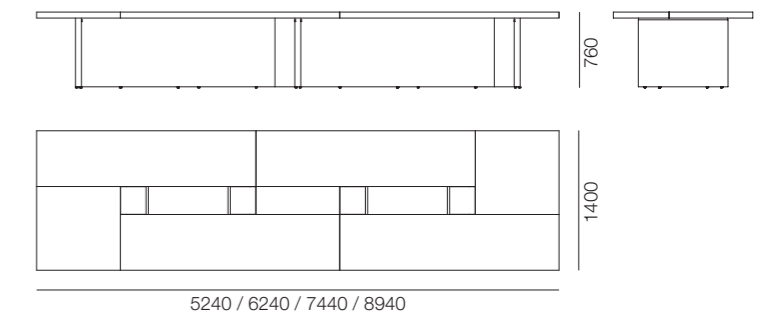

CANALIZZAZIONE TAVOLO RIUNIONE EASY
EASY MEETING TABLE CABLING SYSTEM
CANALISATION TABLE DE RÉUNION EASY

IT— Il tavolo riunione Easy è dotato di un passacavo metallico rettangolare Proficable in alluminio anodizzato con sportello apribile in tinta con il piano.

EN— The Easy meeting table is equipped with a rectangular anodized aluminum Proficable cable tidy with an openable door in the same color as the top.

F— La table de réunion Easy est équipée d'un passe-cable en métal rectangulaire Proficable en aluminium anodisé avec une porte à ouverture de la même couleur que le plateau.

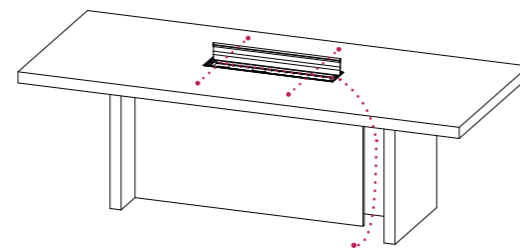
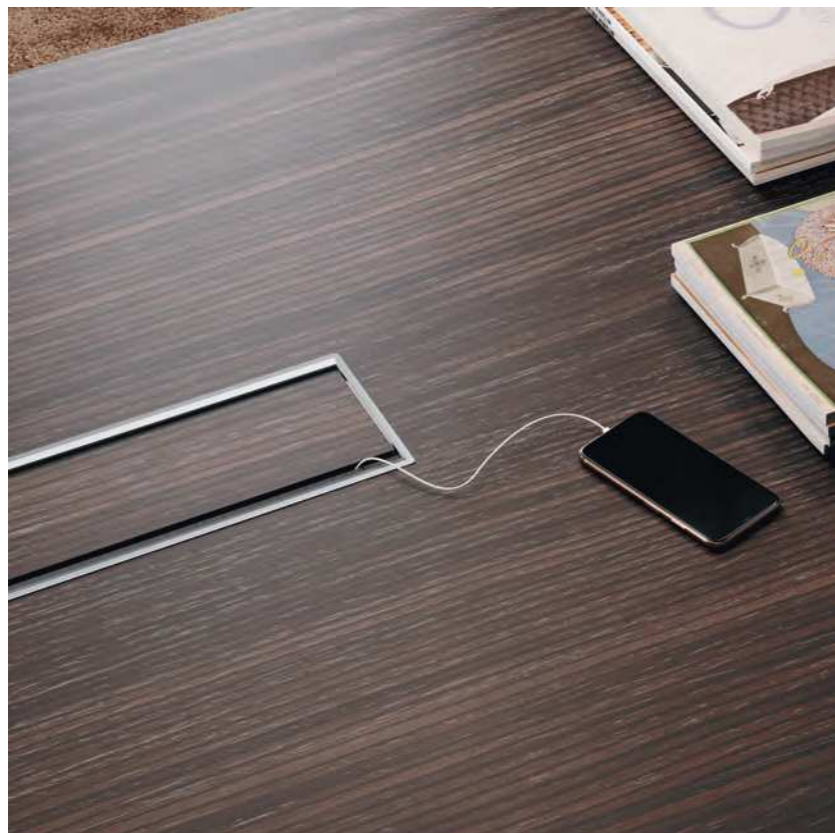

CANALIZZAZIONE TAVOLO RIUNIONE
MEETING TABLE CABLING SYSTEM
CANALISATION TABLE DE RÉUNION

IT— Il tavolo riunione ha una fascia centrale ribassata per la canalizzazione, da giocare con finitura in tinta o a contrasto, che contiene due sportelli apribili per l'uscita dei cavi sul piano.

EN— The meeting table has a central lowered band for cable management, playing matching or opposite finish, with two cable exit flaps.

F— La table de réunion a une bande centrale abaissée pour la canalisation, qui doit être jouée avec une finition assortie ou contrastée, qui contient deux portes qui peuvent être ouvertes pour permettre aux câbles de sortir par le plateau.

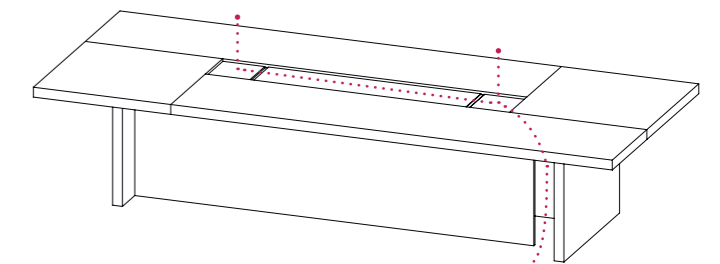
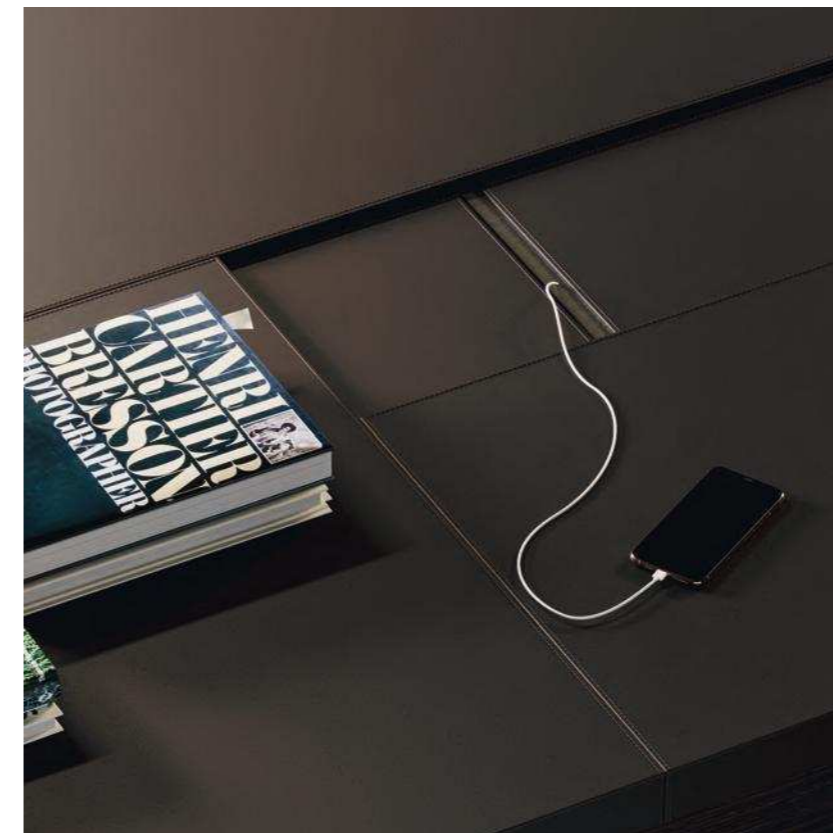

MADIE
SIDEBOARDS
BAHUTS

IT — Gioco di pieni e vuoti caratterizza la collezione di madie disponibili in due altezze.

La madia bassa è composta da un vano a giorno, anta push to open con ripiano in vetro, cestone con cassetto interno ad estrazione totale e chiusura ammortizzata.

La madia media è composta da un vano a giorno, anta push to open con ripiani in vetro, anta ribalta push to open, cestone con cassetto interno ad estrazione totale e chiusura ammortizzata.

In alternativa al cestone, sono disponibili due ante con chiusura ammortizzata.

EN — A play of solid and empty spaces characterise the collection of sideboards available in two heights.

The low sideboard has an open compartment, push to open door with glass shelf, filing drawer with inside drawer with total extraction guides and cushioned closing.

The medium sideboard has an open compartment, push to open door with glass shelves, push to open flap door, filing drawer with inside drawer with total extraction guides and cushioned closing.

As an alternative to the drawer, two doors with cushioned closing are available.

F — Un jeu de solides et de vides caractérise la collection de bahuts disponibles en deux hauteurs.

Le bahut bas est composé d'un compartiment ouvert, d'une porte à ouverture push to open avec étagère en verre, d'un tiroir avec tiroir interne pour une extraction complète et d'un système de fermeture en douceur.

Le bahut moyen est composé d'un compartiment ouvert, porte push to open avec étagères en verre, porte basculante à ouverture push to open, tiroir avec tiroir intérieur pour une extension totale et une fermeture en douceur.

Comme alternative au tiroir pour dossier suspendus, deux portes à fermeture douce sont disponibles.

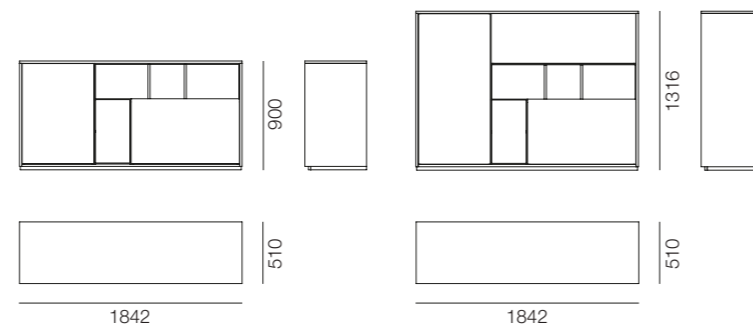



ARMADIO
STORAGE
ARMOIRE

IT — Gioco di pieni e vuoti caratterizza l'armadio composto da un vano a giorno, ante push to open con ripiani in vetro, cestone con cassetto interno ad estrazione totale e chiusura ammortizzata. In alternativa al cestone, sono disponibili due ante con chiusura ammortizzata.

EN — A play of solid and empty spaces characterise the storage with an open compartment, push to open doors with glass shelves, filing drawer with inside drawer with total extraction guides and cushioned closing. As an alternative to the drawer, two doors with cushioned closing are available.

F — Un jeu de solides et de vides caractérise l'armoire composé d'un compartiment ouvert, de portes push to open avec étagères en verre, d'un tiroir avec tiroir intérieur pour une extraction totale et d'une fermeture rembourrée. Comme alternative au tiroir pour dossier suspendus, deux portes à fermeture douce sont disponibles.

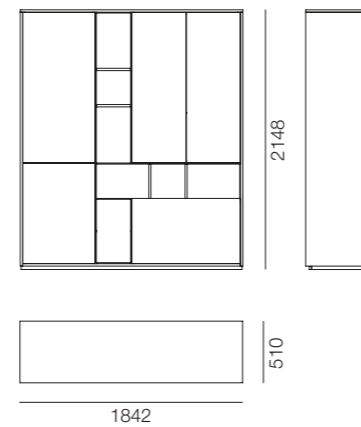



CONSOLLE
CONSOLE
CONSOLE

IT— La consolle ha struttura e due cassetti con frontali sp 60 mm ad estrazione totale e chiusura ammortizzata. Il ripiano e il divisorio centrale sp 18/19 mm sono previsti in tonalità a contrasto o in tinta.

EN— The console has a 60 mm thick structure and two drawers with total extraction guides and cushioned closing. Shelf and divider part have 18/19 mm thick and they are available in contrasting or matching shades.

F— La consolle a une structure et deux tiroirs avec des panneaux frontaux de 60 mm d'épaisseur avec extension totale et fermeture en douceur. La tablette et le séparateur central de 18/19 mm d'épaisseur sont disponibles dans des teintes contrastées ou assorties.

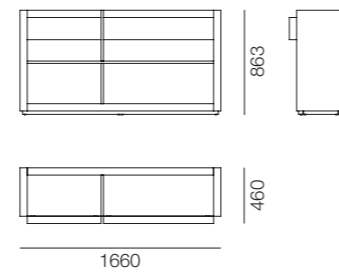

TAVOLI CAFFÈ E PORTARIVISTE
COFFEE TABLES AND MAGAZINES HOLDER
TABLES BASSE ET PORTE REVUES

IT— Collezione di tavolini quadrati e rettangolari disponibili in tre misure, da utilizzare singolarmente o da abbinare tra loro. Hanno struttura e piano in legno sp 18/19 mm. Nella misura quadrata piccola, è prevista la versione portariviste o portavaso (non dotato di contenitore per raccogliere le gocce d'acqua)

EN— Collection of square and rectangular coffee tables in three sizes, to use individually or in combination. They have a 18/19 mm thick wooden structure and top. In the little square size, the magazine holder or a vase holder model is available (not equipped with a container to collect water drops).

F— Collection de tables basses carrées et rectangulaires disponibles en trois tailles, à utiliser individuellement ou combinées les unes aux autres. Ils ont une structure et un plateau en bois de 18/19 mm d'épaisseur. Dans la petite taille carrée, il existe une version porte-revues ou vase (non équipé d'un récipient pour recueillir les gouttes d'eau).

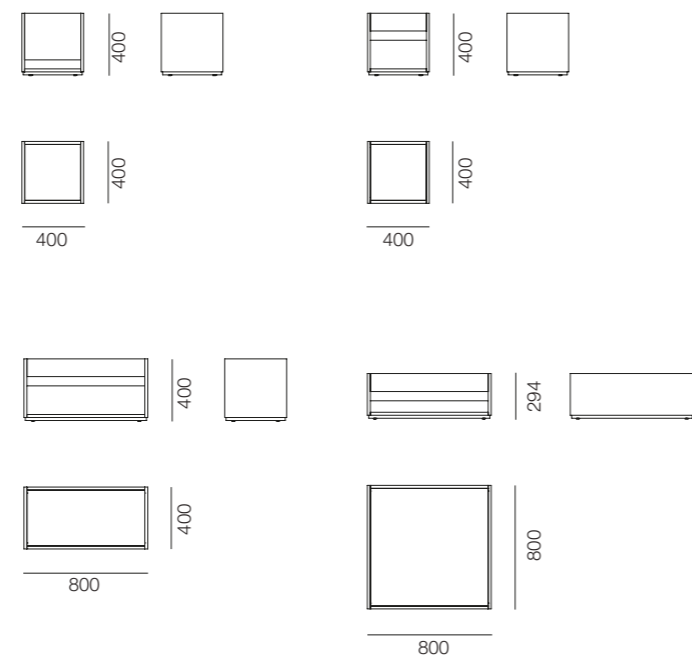

creative & design direction
RMDESIGNSTUDIO / Mariella Vidotti

graphic design & copywriting
RMDESIGNSTUDIO

product design
R&S PROF

photos
concept, set design & styling / RMDESIGNSTUDIO
rendering & styling / SALAPOSA STUDIO

L'azienda si riserva in qualunque momento di apportare senza preavviso modifiche a prodotti, accessori e finiture.

The Manufacturer reserves the right to modify products, accessories and finishings at any time without prior notice.

La Société se réserve le droit à tout moment de faire des changements sans préavis aux produits, accessoires et finitions.

Prof srl - Azienda certificata / Certified Company / Entreprise certifiée



**PR
OF**

PROF srl
Via Cao de Villa 6/A
Località Falzè di Piave
31020 Senaglia della Battaglia, TV / Italy
T +39 0438 903190 F +39 0438 903228
p.iva / cod.fisc IT03134570260
www.profoffice.it info@profoffice.it

