

SLIM

executive collection



**PR
OF**

« CONTENTS »

PAG. 04
CHAPTER 01 - THE COLLECTION

PAG. 14
CHAPTER 02 - THE CATALOGUE

PAG. 16
CHAPTER 03 - PROJECT 01

PAG. 24
CHAPTER 04 - PROJECT 02

PAG. 32
CHAPTER 05 - PROJECT 03

PAG. 42
CHAPTER 06 - PROJECT 04

PAG. 50
CHAPTER 07 - PROJECT 05

PAG. 58
CHAPTER 08 - PROJECT 06

PAG. 66
CHAPTER 09 - PROJECT 07

PAG. 72
CHAPTER 10 - TECHNICALS





« THE COLLECTION »

IT — Elegante e funzionale, la collezione direzionale Slim si rifà il look con l'introduzione di nuovi materiali e preziose finiture. La SCRIVANIA è caratterizzata da una struttura in legno nello spessore di 40 mm disponibile in melaminico, laccato opaco o laccato antigraffio extra opaco soft-touch. Il piano è previsto in melaminico, laccato antigraffio extra opaco soft-touch, vetro laccato anti touch, brillante e stampato effetto marmo, Fenix NTM® e legno impiallacciato. Per soddisfare le esigenze di uno spazio di lavoro flessibile e contemporaneo, sono disponibili tre versioni: la configurazione semplice, quella con dattilo di profondità ridotta e quella con piano dattilo tradizionale. Dal design essenziale, la completano i mobili di servizio dedicati, che aggiungono funzionalità all'ufficio direzionale. I TAVOLI RIUNIONE rettangolari e sagomati sono previsti in varie profondità e possono essere composti con gamba centrale condivisa per la canalizzazione. I TAVOLI CAFFÈ sono disponibili in quattro dimensioni, da accostare singolarmente o combinati tra loro, adatti a sale di attesa, lounge e ambienti domestici.

EN — Elegant and functional, the Slim executive collection takes on the look with the introduction of new materials and precious finishes. The DESK is characterized by a 40 mm thick wooden structure available in melamine, matt lacquered or extra matt soft-touch scratch-resistant lacquered. The top is available in melamine, scratch-resistant extra matt soft-touch lacquered, anti-touch lacquered glass, brilliant and printed marble effect, Fenix NTM® and wood veneer. To meet the needs of a flexible and contemporary workspace, three versions are available: the simple configuration, the one with reduced depth extension and the one with traditional extension surface. The essential design is complemented by dedicated service furniture, which adds functionality to the executive office. The rectangular and shaped MEETING TABLES are provided in various depths and can be composed with a shared central leg for channelling. The COFFEE TABLES are available in four sizes, to be matched individually or combined with each other, suitable for waiting rooms, lounges and domestic environments.

F — Éléгант et fonctionnelle, la collection directionnelle Slim va se refaire le look avec l'introduction de nouveaux matériaux et de finitions précieuses. Le BUREAU se caractérise par une structure en bois de 40 mm d'épaisseur, disponible en mélamine, en laqué mat ou en laqué extra mat résistant aux rayures soft-touch. Le plateau est disponible en mélamine, en laqué extra mat résistant aux rayures, en verre laqué anti empreintes, en effet marbré brillant et imprimé, en Fenix NTM® et en placage de bois. Pour répondre aux besoins d'un espace de travail flexible et contemporain, trois versions sont disponibles: la configuration simple, celle avec un retour à profondeur réduite et celle avec un retour à surface traditionnelle. Le design essentiel est complété par un mobilier de service dédié, qui ajoute de la fonctionnalité au bureau de direction. Les TABLEAUX DE RÉUNION, de forme rectangulaire, sont prévus à différentes profondeurs et peuvent être composés avec un pied central commun pour la canalisation. Les TABLES BASSES sont disponibles en quatre tailles, à assortir individuellement ou à combiner entre elles, et conviennent aux salles d'attente, aux salons et aux environnements domestiques.

CASTORO
BEAVER
CASTOR

piano / top / plateau

LA 7048

laccato antigraffio extra opaco soft-touch
scratch-resistant soft-touch extra matt lacquered
laqué extra mat résistant aux rayures soft-touch

struttura / structure / structure

LA 7048

laccato antigraffio extra opaco soft-touch
scratch-resistant soft-touch extra matt lacquered
laqué extra mat résistant aux rayures soft-touch

gonna / modesty panel / voile de fond

LA 7048

laccato antigraffio extra opaco soft-touch
scratch-resistant soft-touch extra matt lacquered
laqué extra mat résistant aux rayures soft-touch

CASTORO + VERDE BOSCO
BEAVER + FOREST GREEN
CASTOR + VERT FORÊT

piano / top / plateau

LA 7048

laccato antigraffio extra opaco soft-touch
scratch-resistant soft-touch extra matt lacquered
laqué extra mat résistant aux rayures soft-touch

struttura / structure / structure

LA 7010

laccato antigraffio extra opaco soft-touch
scratch-resistant soft-touch extra matt lacquered
laqué extra mat résistant aux rayures soft-touch

gonna / modesty panel / voile de fond

LA 7048

laccato antigraffio extra opaco soft-touch
scratch-resistant soft-touch extra matt lacquered
laqué extra mat résistant aux rayures soft-touch

CASTORO + VERDE BOSCO
BEAVER + FOREST GREEN
CASTOR + VERT FORÊT

piano / top / plateau

LA 7048

laccato antigraffio extra opaco soft-touch
scratch-resistant soft-touch extra matt lacquered
laqué extra mat résistant aux rayures soft-touch

struttura / structure / structure

LA 7010

laccato antigraffio extra opaco soft-touch
scratch-resistant soft-touch extra matt lacquered
laqué extra mat résistant aux rayures soft-touch

gonna / modesty panel / voile de fond

LA 7010

laccato antigraffio extra opaco soft-touch
scratch-resistant soft-touch extra matt lacquered
laqué extra mat résistant aux rayures soft-touch

DESK

IT— La scrivania può essere con struttura, gonna e piano in un'unica tonalità. Si può scegliere in alternativa di abbinare nello stesso colore gonna e piano o struttura e gonna.

EN— The desk can be with structure, modesty panel and top in one shade. Alternatively you can choose to match modesty panel and top or structure and modesty panel in the same color.

F— Le bureau peut être avec structure, voile de fond et dessus dans une seule teinte. Vous pouvez également choisir d'assortir la voile de fond et le dessus ou la structure et la voile de fond de la même couleur.

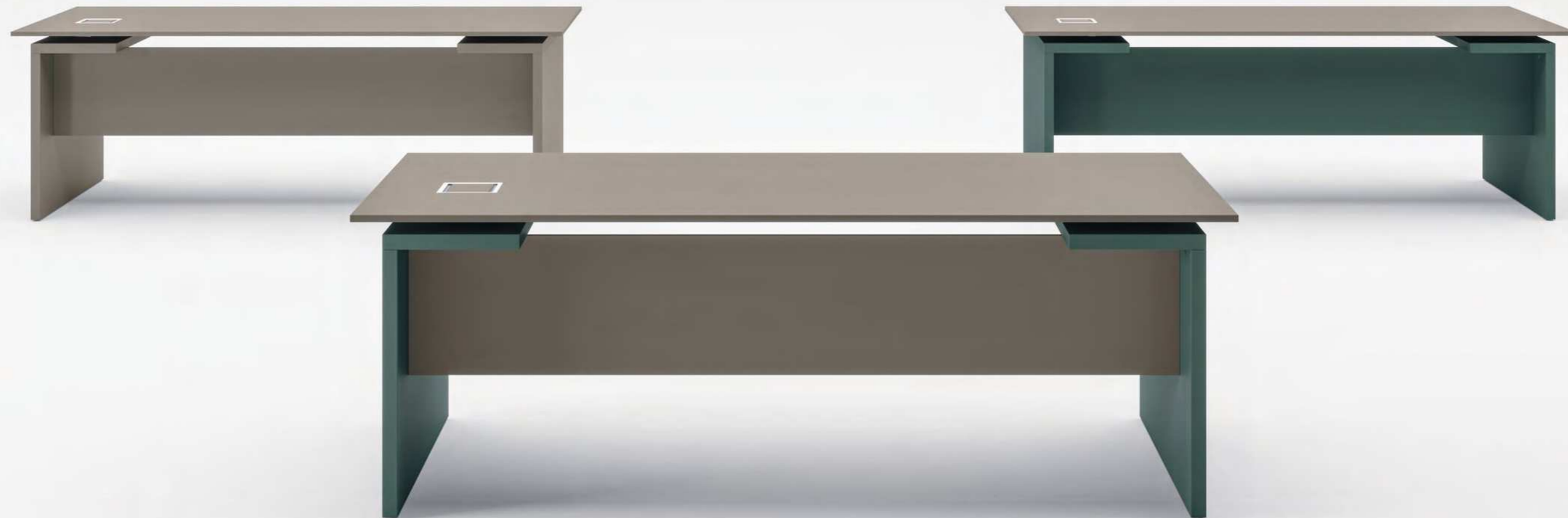

DESK + EXTENSION

IT— Con una gamba speciale dedicata, la scrivania viene proposta in versione con dattilo, a cui si può aggiungere un piano che funge da comoda estensione.

EN— With a special dedicated leg, the desk comes in an extension version, to which a top can be added as a convenient extension.

F— Avec un pied spécial dédié, le bureau existe en version avec retour, à laquelle on peut ajouter un plateau comme retour pratique.

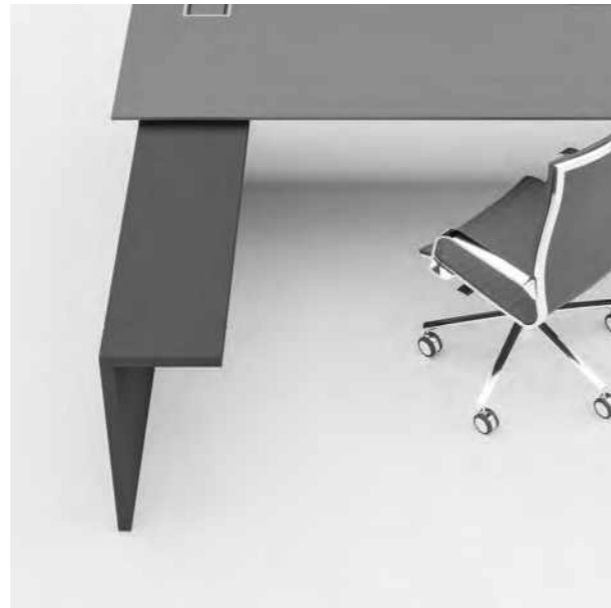

MEETING TABLE

IT— I tavoli riunione rettangolari sono proposti in due profondità e varie lunghezze e possono essere canalizzati con passacavo Profcable con sportello in finitura con il piano.

EN— Rectangular meeting tables are available in two depths and various lengths and can be channeled with Profcable cable tidy with flip top in the same finish as the top.

F— Les tables de réunion rectangulaires sont disponibles en deux profondeurs et différentes longueurs et peuvent être canalisées avec le passe câble Profcable avec top en finition du plateau.

MODULAR MEETING TABLE

IT— Possono essere composti in varie configurazioni modulari, con gamba centrale condivisa per la canalizzazione verticale.

EN— They can be composed in various modular configurations, with shared central leg for vertical channeling.

F— Elles peuvent être composées selon diverses configurations modulaires, avec un pied central commun pour la canalisation verticale.



MEETING TABLE

IT— I tavoli riunione sagomati sono proposti in due profondità e varie lunghezze e possono essere canalizzati con passacavo Profcable con sportello in finitura con il piano.

EN— The shaped meeting tables are available in two depths and various lengths and can be channeled with Profcable cable tidy with flip top in the same finish as the table top.

F— Les tables de réunion en formes sont disponibles en deux profondeurs et différentes longueurs et peuvent être canalisées avec le passe-câble Profcable avec top en finition de dessus.dessus.

**MODULAR MEETING TABLE**

IT— Possono essere composti in varie configurazioni modulari, con gamba centrale condivisa per la canalizzazione verticale.

EN— They can be composed in various modular configurations, with shared central leg for vertical channeling.

F— Elles peuvent être composées selon diverses configurations modulaires, avec un pied central commun pour la canalisation verticale.



« THE CATALOGUE »

IT— Il catalogo propone sette ambientazioni direzionali con scrivanie, tavoli riunioni e area attesa che illustrano le ampie possibilità espressive della collezione. Grazie all'ampia scelta di finiture liberamente accostabili tra loro, Slim è in grado di interpretare una grande varietà di stili con versatilità, dallo spazio executive tradizionale fino a quello contemporaneo. Completano gli ambienti i contenitori Profbox, le librerie Profcase, le lampade Grace e tutti i complementi della collezione Profmood, che consentono di formulare progetti d'arredo sempre più personalizzati, perfettamente abbinati nei materiali e nei colori.

EN— The catalogue proposes seven executive settings with desks, meeting tables and waiting area that illustrate the wide expressive possibilities of the collection. Thanks to the wide choice of finishes that can be freely matched to each other, Slim is able to interpret a wide variety of styles with versatility, from the traditional executive space to the contemporary one. The rooms are completed by Profbox cabinets, Profcase bookcases, Grace lamps and all the complements of the Profmood collection, which make it possible to formulate increasingly personalized furnishing projects, perfectly matched in materials and colours.

F— Le catalogue propose sept décors de direction avec des bureaux, des tables de réunion et une zone d'attente qui illustrent les vastes possibilités d'expression de la collection. Grâce au large choix de finitions qui peuvent être librement assorties les unes aux autres, Slim est en mesure d'interpréter avec polyvalence une grande variété de styles, de l'espace exécutif traditionnel à l'espace contemporain. Les pièces sont complétées par des armoires Profbox, des bibliothèques Profcase, des lampes Grace et tous les accessoires de la collection Profmood, qui permettent de formuler des projets d'ameublement de plus en plus personnalisés, parfaitement assortis dans les matériaux et les couleurs.

Project 01

grigio perla / basalto / nero / rosso rubino
 pearl grey / basalt / black / ruby red
 gris perle / basalte / noir / rouge rubis

IT— La scrivania con dattilo è proposta con piano in vetro laccato anti touch grigio perla, struttura laccata antigraffio extra opaco soft-touch basalto e gonna laccata antigraffio extra opaco soft-touch grigio perla. Versatile e funzionale, la accompagna un mobile di servizio in finitura laccato antigraffio extra opaco soft-touch basalto con vassoio superiore, anta e cassetti ad apertura push to open. Nel fondo, un contenitore Profbox in melaminico grigio perla con maniglia metallica laccata color basalto. I tavoli caffè sono proposti nell'abbinamento melaminico nero e basalto. Il tavolo riunione ha una struttura laccata antigraffio extra opaco soft-touch rosso rubino e un piano sagomato in vetro laccato anti touch rosso rubino, dotato di un passacavo Profcable con sportello apribile in vetro abbinato. Nel fondo, un contenitore Profbox in melaminico grigio perla con maniglia metallica laccata color rosso rubino.

EN— The desk with extension is proposed with pearl grey anti touch lacquered glass top, basalt scratch-resistant soft-touch extra matt lacquered structure and pearl grey scratch-resistant soft-touch extra matt lacquered modesty panel. Versatile and functional, it is accompanied by a service unit in a scratch-resistant soft-touch extra matt basalt lacquered finish with upper glove compartment, push to open door and drawers. In the bottom, a pearl grey melamine Profbox cabinet with basalt lacquered metal handle. The coffee tables are available in black melamine and basalt. The meeting table has a scratch-resistant soft-touch extra matt ruby red lacquered structure and a shaped top in ruby red anti touch lacquered glass, equipped with a Profcable cable tidy with matching glass opening door. In the bottom, a pearl grey melamine Profbox cabinet with ruby red lacquered metal handle.

F— Le bureau avec retour est proposé avec un plateau en verre laqué gris perle anti-empreintes, une structure laquée basalte extra-mat résistant aux rayures soft-touch et une voile de fond laquée gris perle extra-mat résistant aux rayures soft-touch. Polyvalente et fonctionnelle, elle est accompagnée d'un meuble de service en laque basalte extra-mat résistant aux rayures soft-touch, avec plateau supérieur, porte et tiroirs à pousser pour ouvrir. Dans le fond, une Profbox en mélamine gris perle avec une poignée en métal laqué basalte. Les tables basses sont disponibles en mélamine noire et en basalte. La table de réunion a une structure laquée extra mate au toucher doux rouge rubis et un plateau en forme en verre laqué rouge rubis anti-toucher, équipé d'un passe câble Profcable avec porte d'ouverture en verre assortie. Dans le fond, une armoire Profbox en mélamine gris perle avec une poignée en métal laqué rouge rubis.





DESK + EXTENSION — 2200 x 2000 x H 760 mm

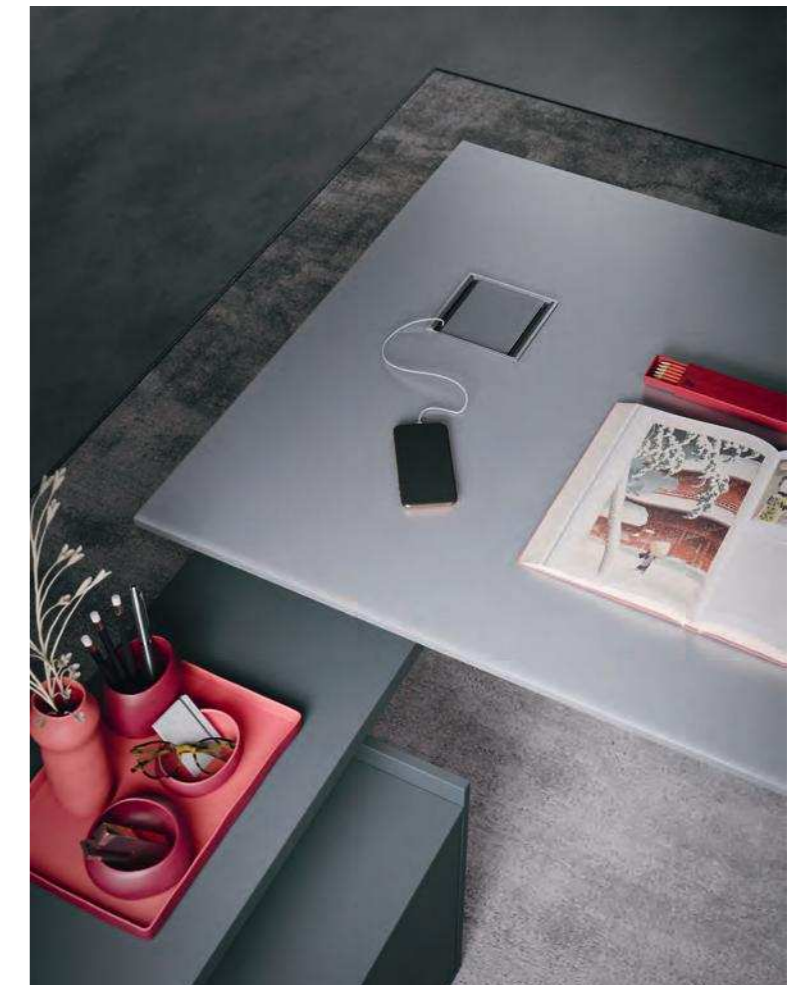



PROFBOX — 1840 x 470 x H 868 mm
1840 x 470 x H 1284 mm



COFFEE TABLES — 500 x 500 x H 450 mm
800 x 400 x H 400 mm



MEETING TABLE — 2800 x 1230 x H 760 mm

Project 02

grigio chiaro / verde pistacchio / stone grey
 light grey / pistachio green / stone grey
 gris clair / vert pistache / stone grey

IT— La scrivania con dattilo è proposta con piano, gonna e mobile di servizio in melaminico color grigio chiaro. A contrasto, la struttura laccata antigraffio extra opaco soft-touch nella tonalità verde pistacchio, come il contenitore Profbox che la accompagna. Il tavolo riunione è caratterizzato da una struttura melaminico grigio chiaro e un piano canalizzato in vetro stampato anti touch stone grey. Abbinato un contenitore Profbox in finitura laccato antigraffio extra opaco soft-touch nei colori grigio chiaro e verde pistacchio.

EN— The desk with extension is proposed with top, modesty panel and service unit in light grey melamine. In contrast, the scratch-resistant soft-touch extra matt lacquered structure in pistachio green shades, like the Profbox cabinet that accompanies it. The meeting table is characterized by a light grey melamine structure and a canalized top in anti-touch stone grey printed glass. Combined with a Profbox cabinet in scratch-resistant soft-touch extra matt lacquered finish in light grey and pistachio green.

F— Le bureau avec retour est proposé avec un plateau, une voile de fond et une meuble de service en mélamine gris clair. En contraste, la structure laquée extra-mat résistant aux rayures soft-touch dans des tons vert pistache, comme l' armoire Profbox qui l'accompagne. La table de réunion est caractérisée par une structure en mélamine gris clair et un plateau canalisé en verre imprimé stone grey anti empreintes. Combiné avec une armoire Profbox en finition laquée extra-mat résistant aux rayures soft-touch, en gris clair et vert pistache.





DESK + EXTENSION — 2200 x 2000 x H 760 mm





PROFBOX — 1840 x 470 x H 1284 mm



PROFBOX — 1840 x 470 x H 1284 mm



MEETING TABLE — 4200 x 1430 x H 760 mm

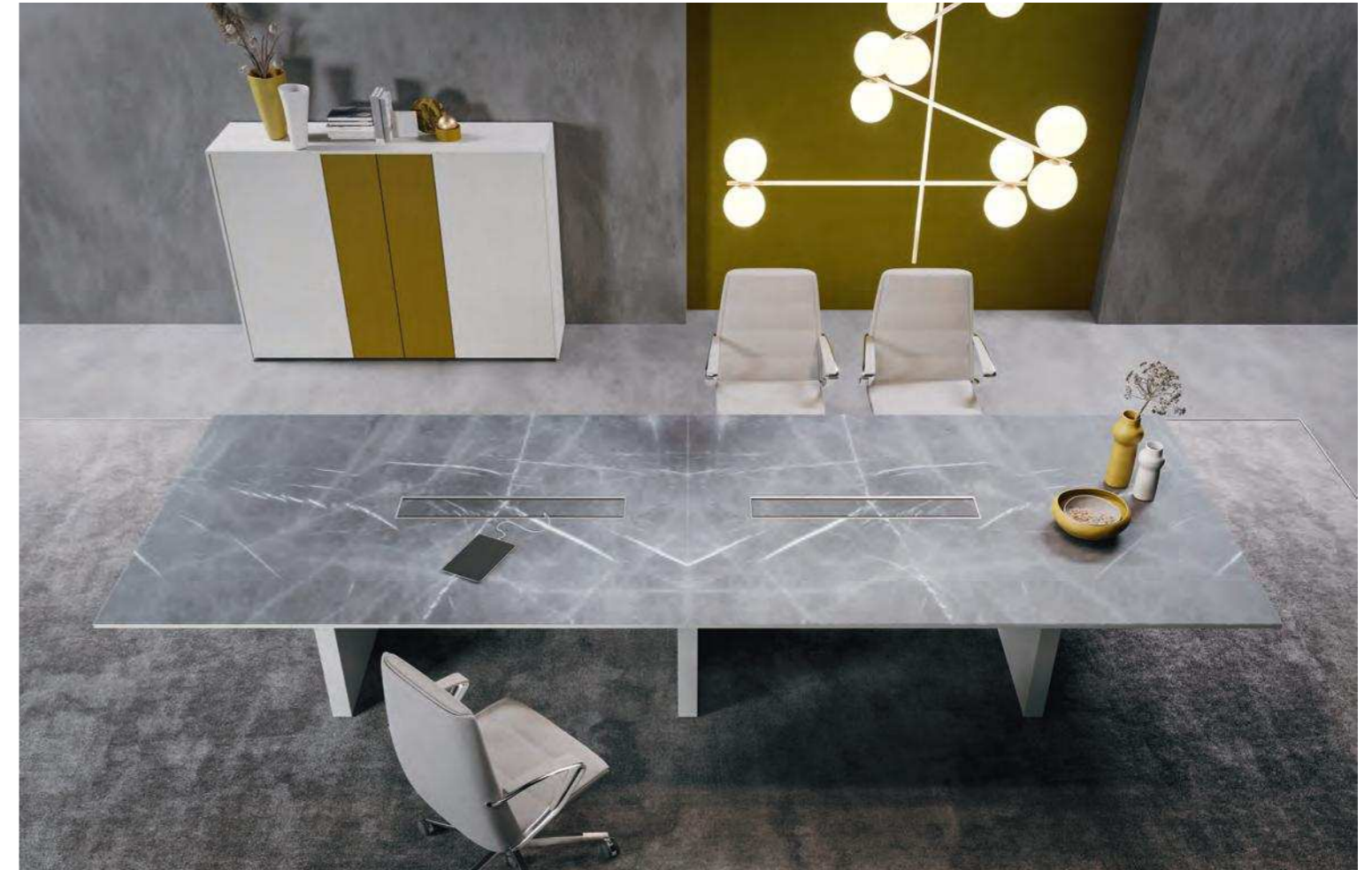

Project 03

bianco / Calacatta oro / desert rose
 white / Calacatta gold / desert rose
 blanc / Calacatta or / desert rose

IT— La scrivania con dattilo è raffigurata con struttura, gonna e mobile di servizio in finitura melaminico bianco. Il piano e il piano dattilo sono in vetro stampato anti touch Calacatta oro. Nel fondo, un mobile contenitore Profbox con ante in vetro stampato anti touch Calacatta oro e struttura bianco melaminico. Negli stessi abbinamenti, il tavolo riunioni sagomato con il piano in vetro stampato anti touch Calacatta oro e struttura bianco melaminico. Lo accompagna un contenitore Profbox con ante ad apertura push to open in laccato antigraffio extra opaco soft-touch desert rose. I tavoli caffè sono nelle finiture melaminico bianco e laccato antigraffio extra opaco soft-touch desert rose.

EN— The desk with extension is shown with structure, modesty panel and service unit in white melamine finish. The top and the extension top are in gold Calacatta anti touch printed glass. At the bottom, a Profbox cabinet with anti-touch printed glass doors Calacatta gold and white melamine structure. In the same combinations, the shaped meeting table with anti-touch printed glass top Calacatta gold and white melamine structure. It is accompanied by a Profbox cabinet with push to open doors in scratch-resistant soft-touch extra matt desert rose lacquered. The coffee tables are in white melamine finish and scratch-resistant soft-touch extra matt desert rose lacquered.

F— Le bureau avec retour est présenté avec une structure, une voile de fond et une meuble de service en mélamine blanche. Le plateau et le plateau retour sont en verre imprimé anti empreintes Calacatta or. Au fond, une armoire Profbox avec des portes en verre imprimé anti empreintes Calacatta or et structure en mélamine blanche. Dans les mêmes combinaisons, la table de réunion en forme avec un plateau en verre imprimé anti-touch Calacatta or et une structure en mélamine blanche. Elle est accompagnée d'une armoire Profbox avec les portes push to open en laqué desert rose extra-mat résistant aux rayures soft-touch. Les tables basses sont en finition mélamine blanche et en laqué desert rose extra-mat résistant aux rayures soft-touch.





DESK + EXTENSION — 2200 x 2000 x H 760 mm



PROFBOX — 1839 x 470 x H 1284 mm



MEETING TABLE — 3600 x 1430 x H 760 mm





PROFBOX — 1840 x 470 x H 868 mm



COFFEE TABLES — 800 x 400 x H 400 mm
500 x 500 x H 450 mm

Project 04

blu sea / rame
 blue sea / copper
 mer bleue / cuivre

IT— La scrivania è presentata con piano, piano dattilo, cassettera e gonna in tonalità melaminico blu sea e con struttura in laccato antigraffio extra opaco soft-touch rame. Il contenitore Profbox abbinato ha ante con apertura push to open e vani a giorno in melaminico blu sea. I tavoli caffè sono proposti negli stessi colori blu sea e rame. Il tavolo riunione rettangolare è in unica finitura melaminico blu sea. Lo accompagna un contenitore Profbox con ante, top e fianchi in laccato antigraffio extra opaco soft-touch rame e inserto con vani a giorno melaminico blu sea.

EN— The desk is presented with top, extension top, pedestal drawers unit and modesty panel in blue sea melamine and with structure in scratch-resistant soft-touch extra matt copper lacquered. The matching Profbox cabinet has push to open doors and open compartments in blue sea melamine. The coffee tables are offered in the same colours blue sea and copper. The rectangular meeting table is in a unique blue sea melamine finish. It is accompanied by a Profbox cabinet with doors, top and sides in scratch-resistant soft-touch extra matt copper lacquered and blue sea melamine open compartments.

F— Le bureau se présente avec un plateau, un plateau retour, une caisson tiroirs et une voile de fond en mélamine bleue mer et avec une structure en laqué cuivre extra-mat résistant aux rayures soft-touch. L' armoire Profbox correspondant a des portes et des compartiments ouverts en mélamine mer bleue. Les tables basses sont proposées dans les mêmes couleurs mer bleue et cuivre. La table de réunion rectangulaire est en mélamine mer bleue, une finition unique. Elle est accompagnée d'une armoire Profbox dont les portes, le dessus et les côtés sont en laqué cuivre extra-mat résistant aux rayures soft-touch et les compartiments ouverts en mélamine bleue mer.





DESK + EXTENSION — 2200 x 2000 x H 760 mm





PROFBOX — 1842 x 470 x H 1284 mm



COFFEE TABLES — 1200 x 400 x H 400 mm
500 x 500 x H 450 mm



MEETING TABLE — 3600 x 1430 x H 760 mm



PROFBOX — 1536 x 470 x H 1284 mm

Project 05

noce natural / beige / curry
 natural walnut / beige / curry
 noyer naturelle / beige / curry

IT— La scrivania con dattilo è presentata con piano, gonna e mobile di servizio in melaminico noce natural e struttura in laccato antigraffio extra opaco soft-touch beige. Nel fondo, un contenitore Profbox in melaminico noce natural con vani a giorno beige. Nello stesso gioco di finiture, accanto al divano i tavoli caffè in due misure. Rigore geometrico per il tavolo riunione modulare interamente in finitura melaminico noce. Lo accompagna un contenitore Profmood in melaminico noce natural con vani a giorni curry.

EN— The desk with extension is presented with top, modesty panel and service unit in natural walnut melamine and structure in scratch-resistant soft-touch extra matt beige lacquered. At the bottom, a Profbox cabinet in natural walnut melamine with beige open compartments. In the same game of finishes, next to the sofa coffee tables in two sizes. Geometric rigour for the modular meeting table entirely in walnut melamine finish. It is accompanied by a Profmood cabinet in natural walnut melamine with curry open compartments.

F— Le bureau avec retour est présenté avec un plateau, une voile de fond et un meuble de service en mélamine noyer naturel et une structure en laqué beige extra-mat résistant aux rayures soft-touch. Au fond, une armoire Profbox en mélamine noyer naturel avec des compartiments ouverts de couleur beige. Dans le même jeu de finitions, à côté du sofa, des tables basses de deux tailles. Rigueur géométrique pour la table de réunion modulaire entièrement en mélaminé noyer. Elle est accompagnée d'une armoire Profmood en mélamine noyer naturelle avec des compartiments ouverts au curry.





DESK + EXTENSION — 2200 x 2000 x H 760 mm



PROFBOX — 1836 x 470 x H 1284 mm





MEETING TABLE — 4200 x 1430 x H 760 mm





PROFBOX — 1836 x 470 x H 1284 mm



COFFEE TABLES — 600 x 400 x H 400 mm
500 x 500 x H 450 mm

Project 06

rovere natural / verde bosco
 natural oak / forest green
 chêne naturel / vert forêt

IT— La scrivania con dattilo è proposta con piano, gonna e mobile di servizio in melaminico rovere natural e struttura in laccato antigraffio extra opaco soft-touch verde bosco. In accostamento, un contenitore Profbox con ante, top e fianchi in laccato antigraffio extra opaco soft-touch verde bosco e inserto con vani a giorno melaminico rovere natural. Il tavolo riunione abbinato è in unica finitura melaminico rovere natural ed è accompagnato da una libreria Profcase in laccato antigraffio extra opaco soft-touch verde bosco con inserto melaminico rovere natural. Nelle stesse finiture sono proposti i tavoli caffè in tre dimensioni diverse.

EN— The desk with extension is proposed with top, modesty panel and service unit in natural oak melamine and structure in scratch-resistant soft-touch extra matt forest green lacquered. In combination, a Profbox cabinet with doors, tops and sides in scratch-resistant soft-touch extra matt forest green lacquered and insert with open compartments in natural oak melamine. The matching meeting table is in a unique natural oak melamine finish and is accompanied by a Profcase bookcase in scratch-resistant soft-touch extra matt forest green lacquered with natural oak melamine insert. In the same finishes are proposed coffee tables in three different sizes.

F— Le bureau avec retour est proposé avec un plateau, une voile de fond et un meuble de service en mélamine chêne naturel et une structure en laqué vert forêt extra-mat résistant aux rayures soft-touch. En combinaison, un conteneur Profbox avec des portes, des dessus et des côtés en laqué vert forêt extra-mat résistant aux rayures soft-touch et un insert avec des compartiments ouverts en mélamine chêne naturel. La table de réunion assortie est en mélamine chêne naturel, finition unique, et est accompagnée d'une librairie Profcase en laqué vert forêt extra-mat résistant aux rayures soft-touch avec insert en mélamine chêne naturel. Dans les mêmes finitions sont proposées des tables basses de trois mesures différentes.





DESK + EXTENSION — 2200 x 2000 x H 760 mm



PROFBOX — 1841 x 470 x H 1284 mm



MEETING TABLE — 3600 x 1430 x H 760 mm



PROFCASE — 3628 x 360 x H 2114



COFFEE TABLES — 800 x 400 x H 400 mm
500 x 500 x H 450 mm
600 x 600 x H 400 mm



Project 07

cacao / beige
 cocoa / beige
 cacao / beige

IT— In versione con dattilo, la scrivania ha il piano in vetro laccato anti touch beige, la gonna in laccato antigraffio extra opaco soft-touch beige e la struttura in laccato antigraffio extra opaco soft-touch cacao. Il servetto abbinato è in laccato antigraffio extra opaco soft-touch beige. Nel fondo due contenitori Profbox, di cui uno in tinta unita laccato antigraffio extra opaco soft-touch beige con vani a giorno melaminico beige, l'altro antigraffio extra opaco soft-touch cacao con vani a giorno melaminico beige.

EN— In the extension version, the desk has the top in beige anti touch lacquered glass, the modesty panel in scratch-resistant soft-touch extra matt beige lacquered and the structure in scratch-resistant soft-touch extra matt cocoa lacquered. The matching service unit is in scratch-resistant soft-touch extra matt beige lacquered. In the bottom there are two Profbox cabinets, one of which is in a solid colour scratch-resistant soft-touch extra matt beige lacquered with open compartments in beige melamine, the other in scratch-resistant soft-touch extra matt cocoa lacquered with open compartments in beige melamine.

F— Dans la version avec retour, le bureau a un plateau en verre laqué beige anti touch, une voile de fond en laqué beige extra-mat résistant aux rayures soft-touch et une structure en laqué cacao extra-mat résistant aux rayures soft-touch. Le meuble de service assorti est en laqué beige extra-mat résistant aux rayures soft-touch. Dans le fond, il y a deux armoires Profbox, dont l'un est en laqué de couleur unie, beige extra-mat résistant aux rayures soft-touch avec des compartiments ouverts en mélamine beige, l'autre en laqué cacao extra-mat résistant aux rayures soft-touch doux avec des compartiments ouverts en mélamine beige.





DESK + EXTENSION — 2200 x 2000 x H 760 mm



PROFBOX — 1836 x 470 x H 868 mm



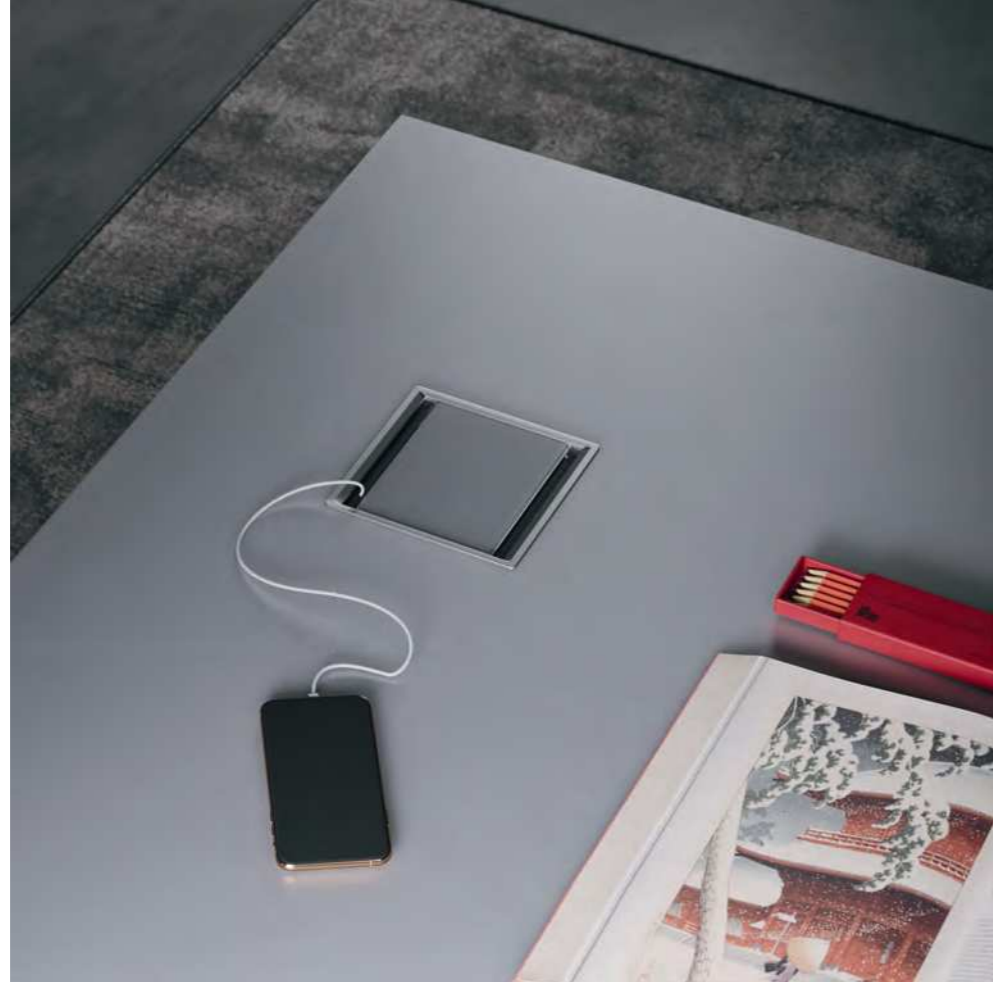

« TECHNICALS »

IM - IMPIALLACCIATO LEGNO / WOOD VENEER / PLAQUÉ BOIS



44
noce Canaletto
walnut Canaletto
noyer Canaletto

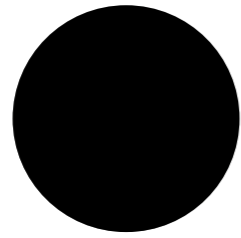

50
rovere termotrattato
thermotreated oak
chêne traité thermiquement

FX - FENIX NTM® / FENIX NTM® / FENIX NTM®

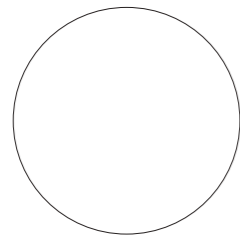

0032
bianco
white
blanc

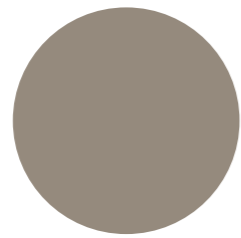

0717
castoro
beaver
castor

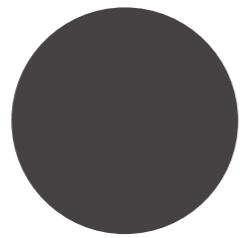

0749
cacao
cocoa
cacao

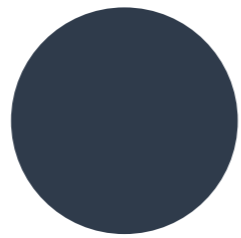

0754
blu scuro
dark blue
bleu foncé

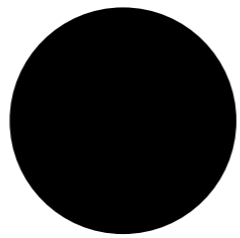

0720
nero
black
noir

ME - MELAMINICO / MELAMINE / MÉLAMINÉ



71
rovere natural
natural oak
chêne naturel



75
noce natural
natural walnut
noyer naturelle



77
noce dark
dark walnut
noyer foncé

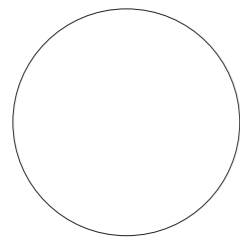

20
bianco
white
blanc



01
grigio chiaro
light grey
gris clair

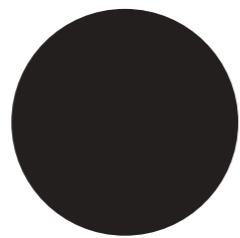

04
nero
black
noir

MC - COLORE MELAMINICO / MELAMINE COLOR / COULEUR MÉLAMINÉE

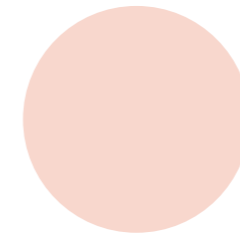

31
cipria
powder
poudre

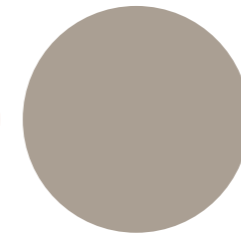

26
beige
beige
beige

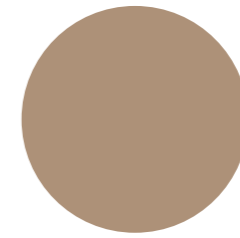

23
cappuccino
cappuccino
cappuccino

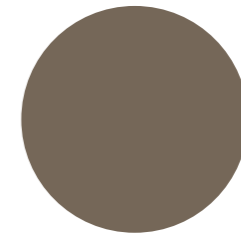

25
tabacco
tobacco
tabac

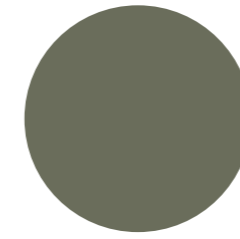

24
verde oliva
olive green
vert olive

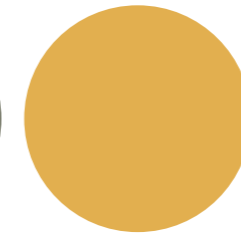

32
curry
curry
curry

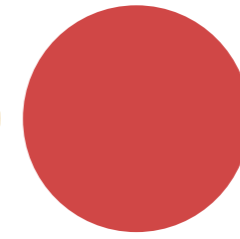

29
rosso oriente
orient red
rouge orient

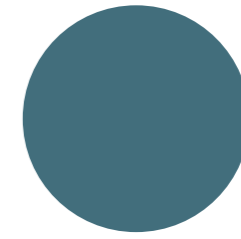

33
petrolio
petroleum
pétrole

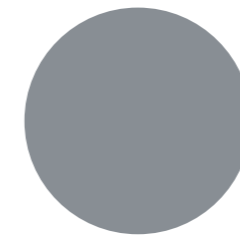

34
grigio perla
pearl grey
gris perle

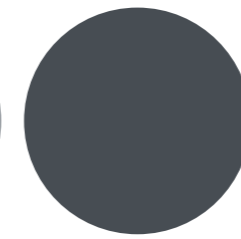

30
basalto
basalt
basalte

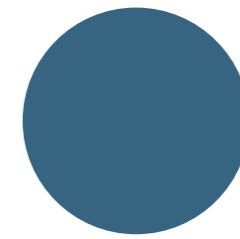

35
blu sea
blue sea
mer bleue

LO - LACCATO OPACO / MATT LACQUERED / LAQUÉ MAT

LA - LACCATO ANTIGRAFFIO EXTRA OPACO SOFT-TOUCH
SCRATCH-RESISTANT SOFT-TOUCH EXTRA MATT LACQUERED
LAQUÉ EXTRA MAT RÉSISTANT AUX RAYURES SOFT-TOUCH

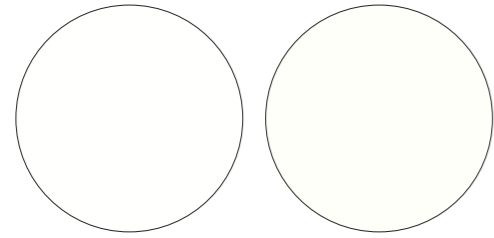

9016
bianco neve
snow white
blanche neige

9010
bianco
white
blanc

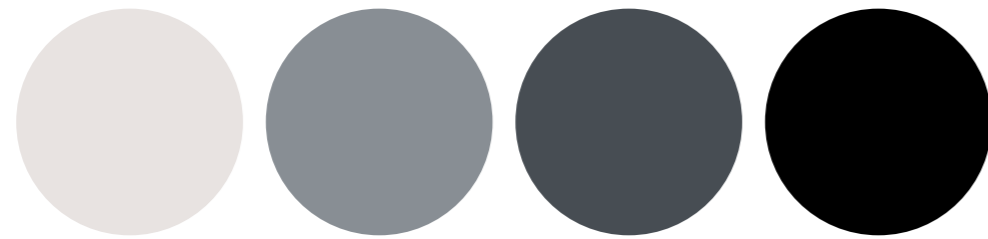

1500
grigio chiaro
light grey
gris clair

4500
grigio perla
pearl grey
gris perle

7500
basalto
basalt
basalte

9005
nero
black
noir

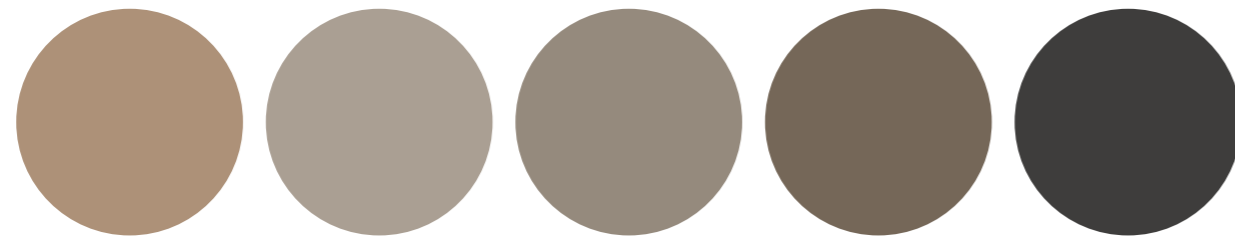

3010
cappuccino
cappuccino
cappuccino

3005
beige
beige
beige

7048
castoro
beaver
castor

6005
tabacco
tobacco
tabac

7502
cacao
cocoa
cacao

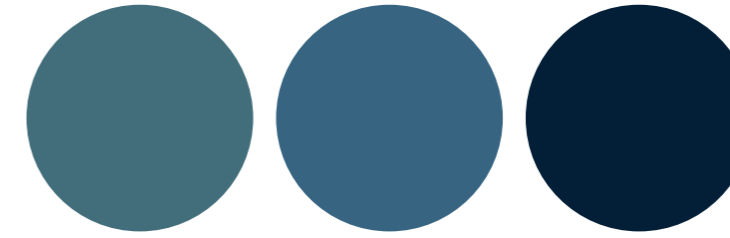

5020
petrolio
petroleum
huile

6020
blu sea
blue sea
mer bleue

5011
blu scuro
dark blue
bleu foncé

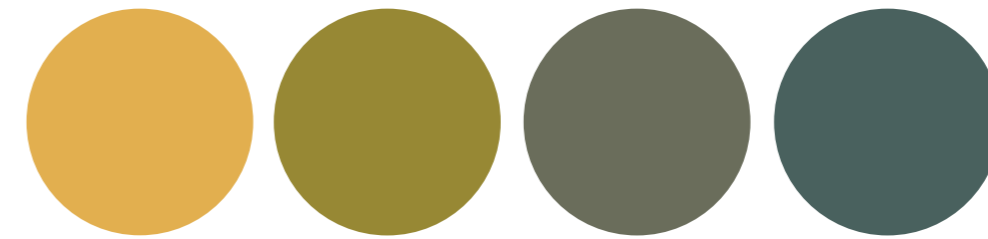

2060
curry
curry
curry

4050
verde pistacchio
pistachio green
vert pistache

6010
verde oliva
olive green
vert olive

7010
verde bosco
forest green
vert forêt

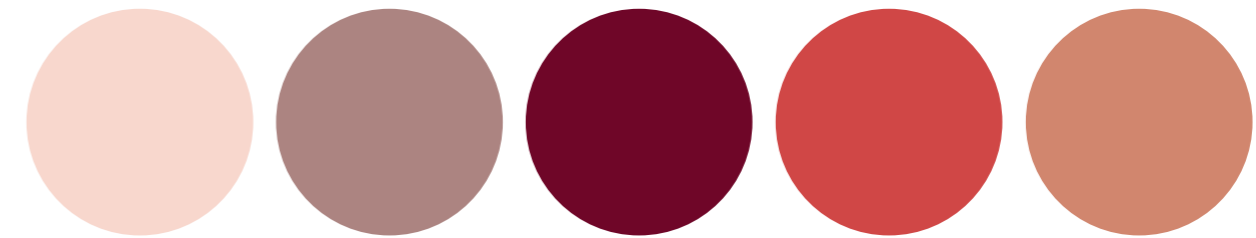

1510
cipria
powdre pink
poudre

4020
desert rose
desert rose
desert rose

3004
rosso rubino
ruby red
rouge rubis

2070
rosso oriente
orient red
rouge orient

3012
rame
copper
cuivre

VB - VETRO LACCATO BRILLANTE / BRILLIANT LACQUERED GLASS / VERRE LAQUÉ BRILLANT

VA - VETRO LACCATO ANTI TOUCH / ANTI TOUCH LACQUERED GLASS / VERRE LAQUÉ ANTI EMPREINTES

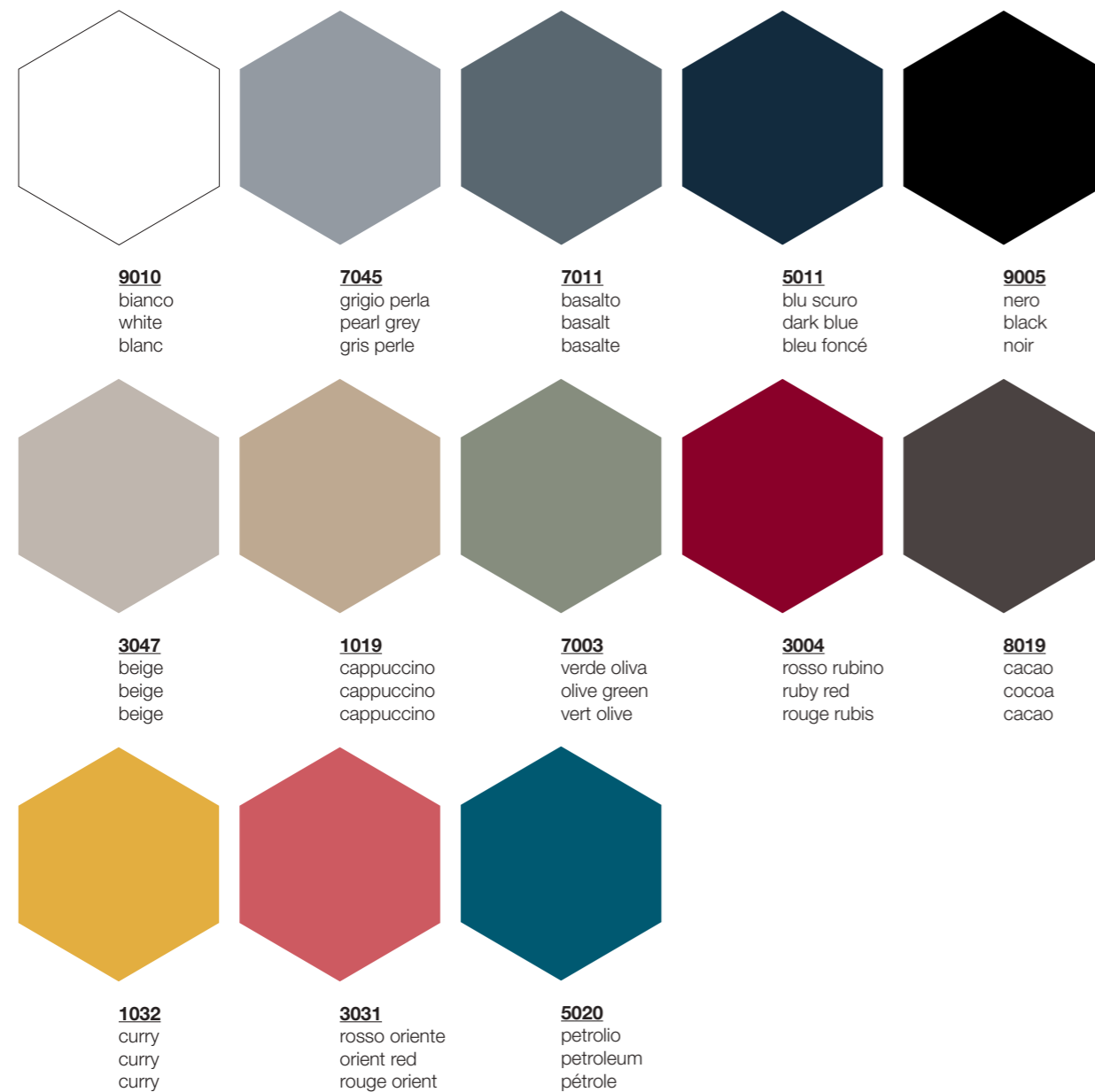

SB - VETRO STAMPATO BRILLANTE / BRILLIANT PRINTED GLASS / VERRE IMPRIMÉ BRILLANT

SA - VETRO STAMPATO ANTI TOUCH / ANTI TOUCH PRINTED GLASS / VERRE IMPRIMÉ ANTI EMPREINTES

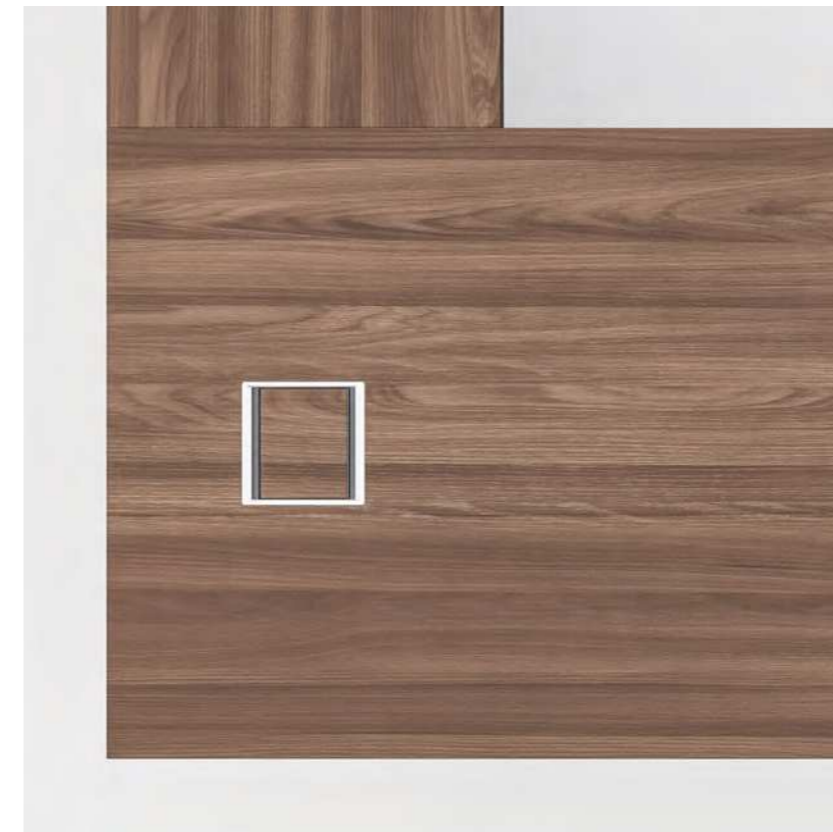
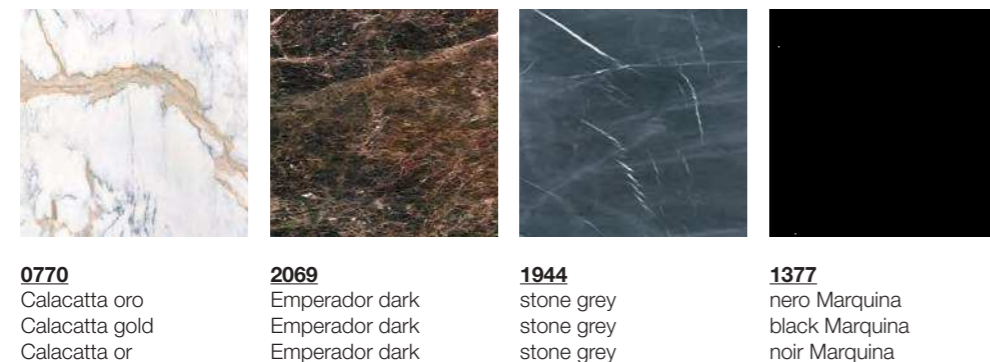

CANALIZZAZIONE SCRIVANIE + TAVOLI RIUNIONE
DESKS + MEETING TABLES CABLING SYSTEM
CANALISATION BUREAUX + TABLES DE RÉUNION

IT— Il piano può avere un passacavo Proficable quadrato in finitura anodizzata o verniciato con sportello apribile in tinta con il piano.

EN— The top can have a square Proficable in anodized or painted finish with an openable door in the same color as the top.

F— Le plateau peut comporter un passe-câble Proficable carré en aluminium anodisé or peint avec une porte ouvrable de la même couleur que le plateau.

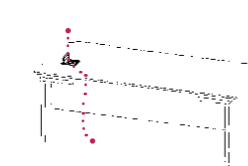

Scrivania
Desk
Bureau

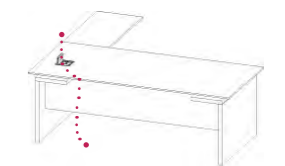

Scrivania + dattilo
Desk + extension
Bureau + retour

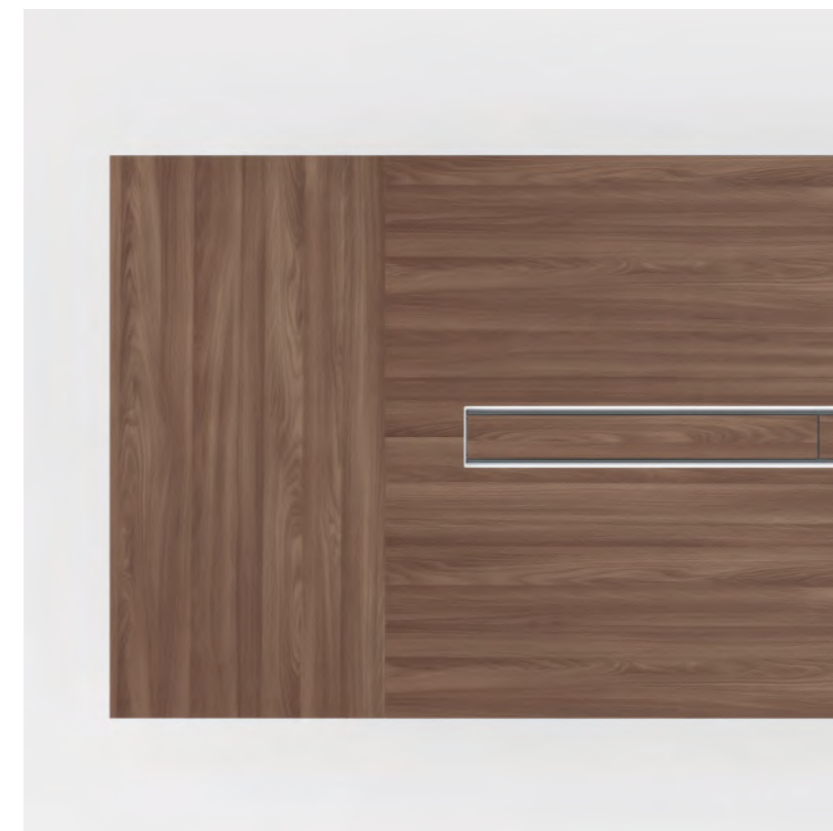

IT— Il piano può avere un passacavo Proficable rettangolare in finitura anodizzata o verniciato con sportello apribile in tinta con il piano. Le gambe sono apribili per la canalizzazione verticale.

EN— The top can have a rectangular Proficable in anodized or painted finish with an openable door in the same color as the top. The legs are openable for vertical ducting.

F— Le plateau peut comporter un passe-câble Proficable rectangulaire en aluminium anodisé or peint avec une porte ouvrable de la même couleur que le plateau. Les pieds sont ouvrables pour le câblage vertical.

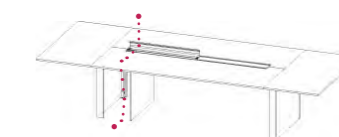

Tavolo riunione rettangolare
Rectangular meeting table
Table de réunion rectangulaire



Tavolo riunione sagomato
Shaped meeting table
Table de réunion en forme



SCRIVANIA
DESK
BUREAU

IT— La scrivania ha una struttura composta da due gambe in legno disponibili nelle finiture bianco e nero melaminico, laccato opaco o laccato antigraffio extra opaco soft-touch. I piani possono essere in legno melaminico, laccato antigraffio extra opaco soft-touch, Fenix NTM® e impiallacciato con spessore di 18/19 mm. Il piano è anche previsto in vetro laccato anti touch e brillante o stampato effetto marmo anti touch e brillante. Il piano in vetro ha spessore totale 18 mm con lastre di 4 mm su supporto melaminico bianco o nero sp.14 mm con bordo in tinta con il piano.

EN— The desk has a structure composed of two wooden legs available in white and black melamine, matt lacquered or scratch-resistant soft-touch extra matt lacquered. The tops can be in melamine wood, scratch-resistant soft-touch extra matt lacquered, Fenix NTM® and wood veneer with a thickness of 18/19 mm. The top is also available in anti-touch and brilliant lacquered glass or printed with anti-touch and brilliant marble effect. The glass top has a total thickness of 18 mm with sheets of 4 mm on a white or black melamine support 14 mm thick with edge matching the top.

F— Le bureau a une structure composée de deux pieds en bois disponibles en mélamine blanche et noire, laqués mats ou laqués extra-mat résistant aux rayures soft-touch. Les plateaux peuvent être en bois de mélamine, en laqué extra-mat résistant aux rayures soft-touch, en Fenix NTM® et en placage d'une épaisseur de 18/19 mm. Le plateau est également disponible en verre laqué anti empreintes et brillant ou imprimé avec un effet marbre anti empreintes et brillant. Le plateau en verre a une épaisseur totale de 18 mm avec des feuilles de 4 mm sur un support en mélamine blanche ou noire de 14 mm d'épaisseur avec un bord assorti au plateau.

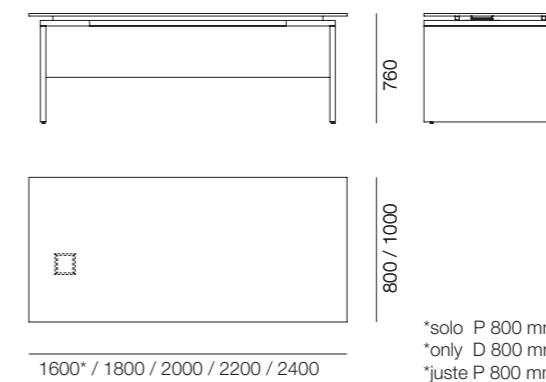
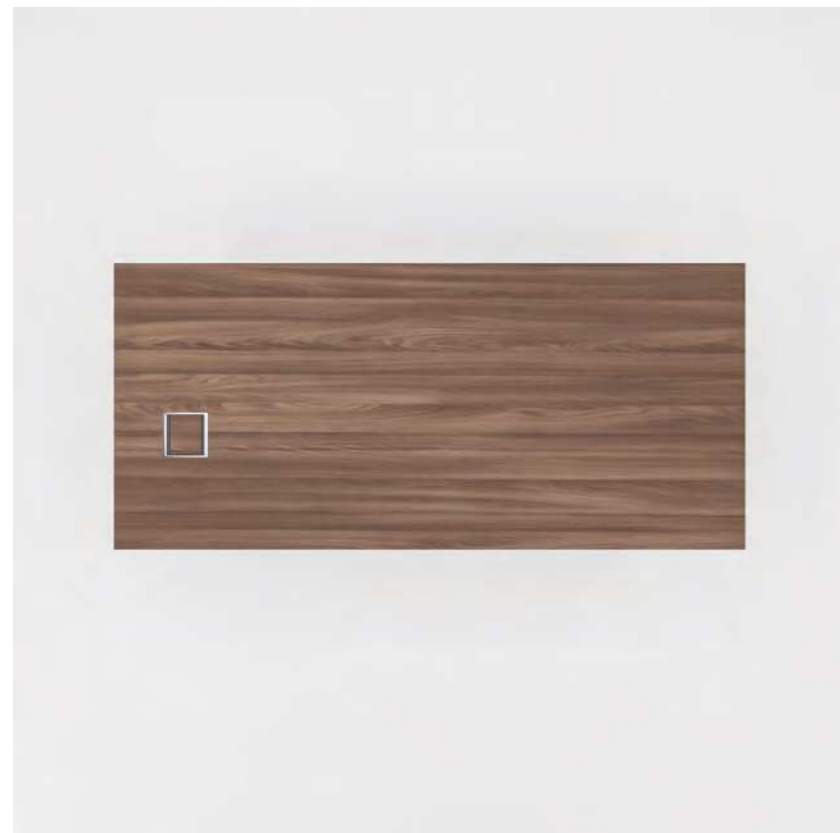



SCRIVANIA + DATILO
DESK + EXTENSION
BUREAU + RETOUR

IT— La scrivania ha una struttura composta da due gambe in legno, di cui una speciale che funge da piano dattilo ridotto, disponibili nelle finiture bianco e nero melaminico, laccato opaco o laccato antigraffio extra opaco soft-touch. I piani possono essere in legno melaminico, laccato antigraffio extra opaco soft-touch, Fenix NTM® e impiallacciato con spessore di 18/19 mm. Il piano è anche previsto in vetro laccato anti touch e brillante o stampato effetto marmo anti touch e brillante. Il piano in vetro ha spessore totale 18 mm con lastre di 4 mm su supporto melaminico bianco o nero sp.14 mm con bordo in tinta con il piano.

EN— The desk has a structure made up of two wooden legs, one of which is a special one that acts as a reduced extension top, available in white and black melamine, matt lacquered or scratch-resistant soft-touch extra matt lacquered finishes. The tops can be in melamine wood, scratch-resistant soft-touch extra matt lacquered, Fenix NTM® and wood veneer with a thickness of 18/19 mm. The top is also available in anti- touch and brilliant lacquered glass or printed with anti- touch and brilliant marble effect. The glass top has a total thickness of 18 mm with sheets of 4 mm on a white or black melamine support 14 mm thick with edge matching the top.

F— Le bureau a une structure composée de deux pieds en bois, dont un spécial qui fait de plateau retour réduit, disponible en mélamine blanche et noire, en laqué mat ou en laqué extra-mat résistant aux rayures soft-touch. Les plateaux peuvent être en bois de mélamine, en laqué extra-mat résistant aux rayures soft-touch, en Fenix NTM® et en plaqué bois dans une épaisseur de 18/19 mm. Le plateau est également disponible en verre laqué anti empreintes et brillant ou imprimé avec un effet marbre anti empreintes et brillant. Le plateau en verre a une épaisseur totale de 18 mm avec des feuilles de 4 mm sur un support en mélamine blanche ou noire de 14 mm d'épaisseur avec un bord assorti au plateau.

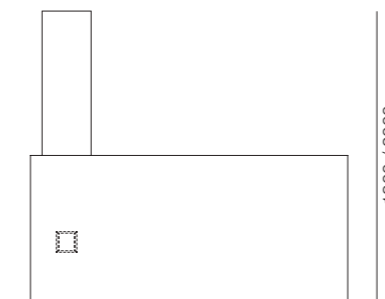
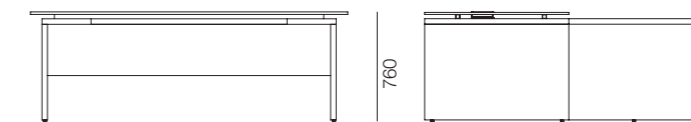
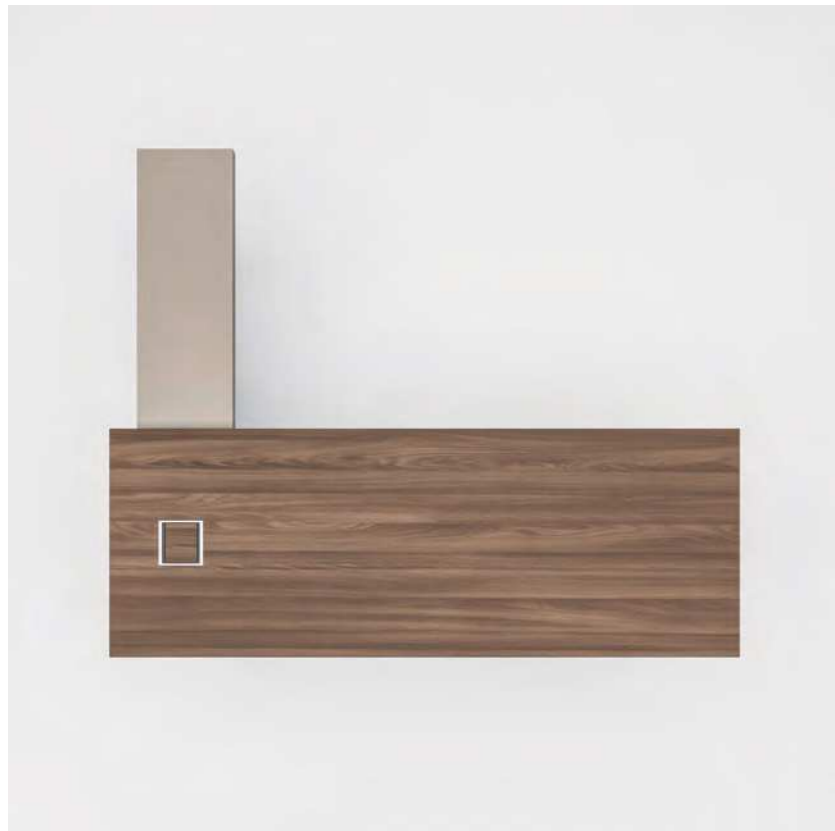

1600* / 1800 / 2000 / 2200 / 2400

*solo P 1800 mm
 *only D 1800 mm
 *juste P 1800 mm



SCRIVANIA + DATTILO + PIANO DATTILO
DESK + EXTENSION + EXTENSION TOP
BUREAU + RETOUR + PLATEAU RETOUR

IT— La scrivania ha una struttura composta da due gambe in legno, di cui una speciale che accoglie il piano dattilo tradizionale, disponibili nelle finiture bianco e nero melaminico, laccato opaco o laccato antigraffio extra opaco soft-touch. I piani possono essere in legno melaminico, laccato antigraffio extra opaco soft-touch, Fenix NTM® e impiallacciato con spessore di 18/19 mm. Il piano è anche previsto in vetro laccato anti touch e brillante o stampato effetto marmo anti touch e brillante. Il piano in vetro ha spessore totale 18 mm con lastre di 4 mm su supporto melaminico bianco o nero sp.14 mm con bordo in tinta con il piano.

EN— The desk has a structure made up of two wooden legs, one of which is a special one that accommodates the traditional extension top, available in white and black melamine, matt lacquered or scratch-resistant soft-touch extra matt lacquered finishes. The tops can be in melamine wood, scratch-resistant soft-touch extra matt lacquered, Fenix NTM® and wood veneer with a thickness of 18/19 mm. The top is also available in anti -touch and brilliant lacquered glass or printed with anti -touch and brilliant marble effect. The glass top has a total thickness of 18 mm with sheets of 4 mm on a white or black melamine support 14 mm thick with edge matching the top.

F— Le bureau a une structure composée de deux pieds en bois, dont un spécial qui accueille le traditionnel plateau retour, disponible en mélaminé blanc et noir, en laqué mat ou en laqué extra mat résistant aux rayures soft-touch. Les plateaux peuvent être en bois de mélamine, en laqué extra-mat résistant aux rayures soft-touch, en Fenix NTM® et en plaqué bois d'une épaisseur de 18/19 mm. Le plateau est également disponible en verre laqué anti empreintes et brillant ou imprimé avec un effet marbre anti empreintes et brillant. Le plateau en verre a une épaisseur totale de 18 mm avec des feuilles de 4 mm sur un support en mélamine blanche ou noire de 14 mm d'épaisseur avec un bord assorti au plateau.

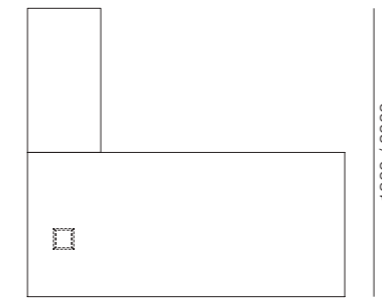
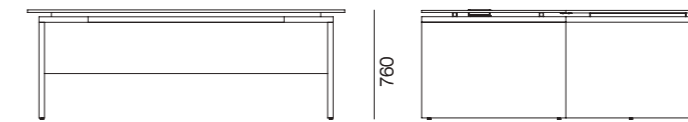

1600* / 1800 / 2000 / 2200 / 2400

*solo P 1800 mm
 *only D 1800 mm
 *juste P 1800 mm



CASSETTIERA SU RUOTE
PEDESTAL DRAWERS UNIT ON CASTORS
CAISSON TIROIRS SUR ROULETTES

IT— Cassettiera su ruote con tre cassetti e serratura. È disponibile in legno melaminico, laccato antigraffio extra opaco soft-touch, Fenix NTM® e impiallacciato.

EN— Pedestal three drawers unit on castors with lock. It is available in melamine, scratch-resistant soft-touch extra matt lacquered, Fenix NTM® and wood veneer.

F— Caisson tiroirs sur roulettes avec trois tiroirs et serrure. Il est disponible en mélamine, laqué extra mat résistant aux rayures soft-touch, Fenix NTM® et plaqué bois.

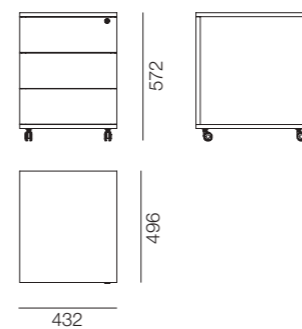
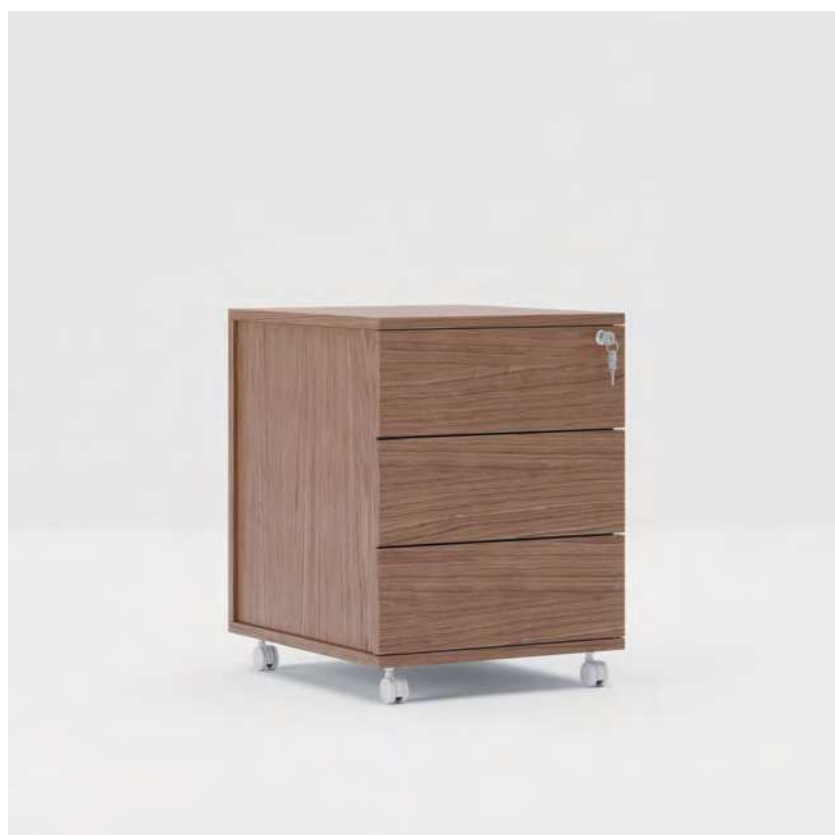

CASSETTIERA SU RUOTE
PEDESTAL DRAWERS UNIT ON CASTORS
CAISSON TIROIRS SUR ROULETTES

IT— Cassettiera su ruote con due cassetti, serratura e vassoio porta oggetti. È disponibile in legno melaminico, laccato antigraffio extra opaco soft-touch, Fenix NTM® e impiallacciato.

EN— Pedestal two drawers unit on castors with lock and vassoio porta oggetti. It is available in melamine, scratch-resistant soft-touch extra matt lacquered, Fenix NTM® and wood veneer.

F— Tiroir à roulettes avec deux tiroirs, serrure et plateau pour objets. Il est disponible en mélamine, laqué extra mat résistant aux rayures soft-touch, Fenix NTM® et plaqué bois.

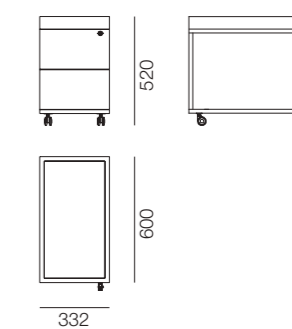

SERVETTO
SERVICE UNIT
MEUBLE DE SERVICE

IT— Mobile di servizio disponibile su ruote o fisso con vassoio superiore, anta e due cassetti push to open. È disponibile in legno melaminico, laccato antigraffio extra opaco soft-touch, Fenix NTM® e impiallacciato.

EN— Service unit available on castors or fixed with upper glove compartment, push to open door and two drawers. It is available in melamine wood, scratch-resistant soft-touch extra matt lacquered, Fenix NTM® and wood veneer.

F— Meuble de service disponible sur roulettes ou fixe avec plateau supérieur pour objets, porte et deux tiroirs push to open. Il est disponible en bois mélaminé, en laqué extra mat résistant aux rayures soft-touch, en Fenix NTM® et en plaqué bois.

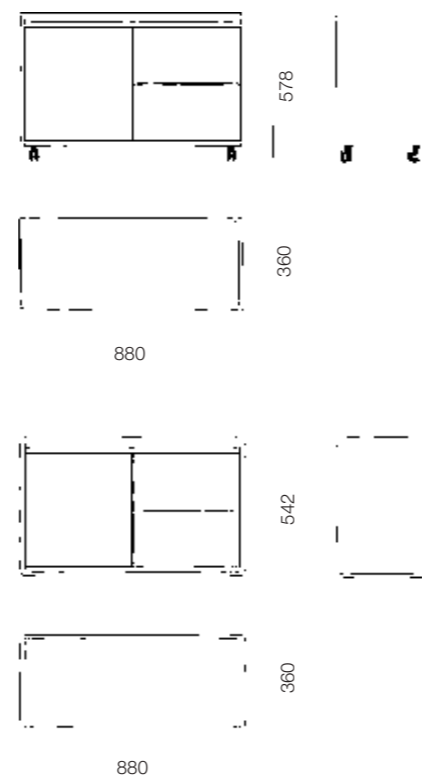

SERVETTO SU RUOTE
SERVICE UNIT ON CASTORS
MEUBLE DE SERVICE SUR ROULETTES

IT— Mobili di servizio su ruote con vani a giorno, tre cassetti e nella versione più ampia con anta push to open e serratura. Sono disponibili in legno melaminico, laccato antigraffio extra opaco soft-touch, Fenix NTM® e impiallacciato.

EN— Service units on castors with open compartments, three drawers and in the larger version with push to open door and lock. They are available in melamine wood, scratch-resistant soft-touch extra matt lacquered, Fenix NTM® and wood veneer.

F— Meubles de service sur roulettes avec des compartiments ouverts, trois tiroirs et, dans la version plus large, avec porte push to open et serrure. Ils sont disponibles en bois de mélamine, en laqué extra mat résistant aux rayures soft-touch, en Fenix NTM® et en plaqué bois.

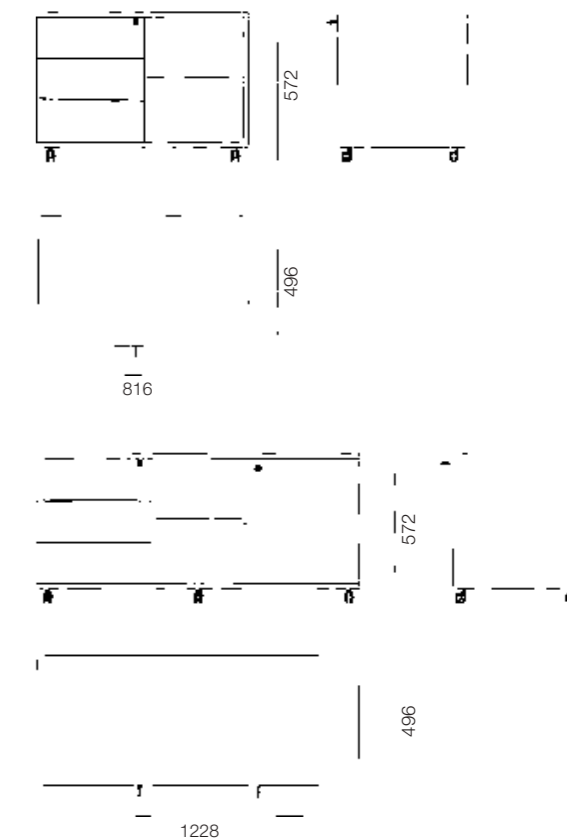

TAVOLO RIUNIONE
MEETING TABLE
TABLE DE RÉUNION

IT— Il tavolo riunione rettangolare, previsto in due profondità e più lunghezze, ha una struttura composta da due gambe disponibili in legno melaminico, laccato opaco o laccato antigraffio extra opaco soft-touch, Fenix NTM® e impiallacciato, i piani possono essere in legno melaminico, laccato antigraffio extra opaco soft-touch, Fenix NTM® e impiallacciato con spessore di 18/19 mm. Il piano è anche previsto in vetro laccato anti touch e brillante o stampato effetto marmo anti touch e brillante. Il piano in vetro ha spessore totale 18 mm con lastre di 4 mm su supporto melaminico bianco o nero sp.14 mm con bordo in tinta con il piano.

EN— The rectangular meeting table, available in two depths and more lengths, has a structure composed of two legs available in melamine wood, matt lacquered or scratch-resistant soft-touch extra matt lacquered, Fenix NTM® and wood veneer. The tops can be in melamine wood, scratch-resistant soft-touch extra matt lacquered, Fenix NTM® and wood veneer with a thickness of 18/19 mm. The top is also available in anti-touch and brilliant lacquered glass or available in anti-touch and brilliant marbled effect. The glass top has a total thickness of 18 mm with sheets of 4 mm on a white or black melamine support 14 mm thick with edge matching the top.

F— La table de réunion rectangulaire, disponible en deux profondeurs et plusieurs longueurs, a une structure composée de deux pieds disponibles en bois mélaminé, laqué mat ou laqué extra mat résistant aux rayures soft-touch, Fenix NTM® et plaqué bois. Les plateaux peuvent être en bois mélaminé, laqué extra mat résistant aux rayures soft-touch, Fenix NTM® et plaqué bois d'une épaisseur de 18/19 mm. Le plateau est également disponible en verre laqué anti empreintes et brillant ou en marbre imprimé à effet anti empreintes et brillant. Le plateau en verre a une épaisseur totale de 18 mm avec des feuilles de 4 mm sur un support en mélamine blanche ou noire de 14 mm d'épaisseur avec un bord assorti au plateau.

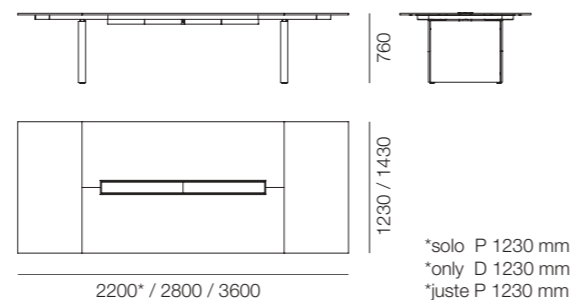

TAVOLO RIUNIONE MODULARE
MODULAR MEETING TABLE
TABLE DE RÉUNION MODULAIRE

IT— Il tavolo riunione modulare è composto da piani componibili in due profondità e più lunghezze con gamba centrale condivisa per la canalizzazione verticale.

EN— The modular meeting table is composed of modular tops in two depths and more lengths with shared central leg for vertical channeling.

F— La table de réunion modulaire est composée de plateaux modulaires en deux profondeurs et plusieurs longueurs avec un pied central commun pour la canalisation verticale.

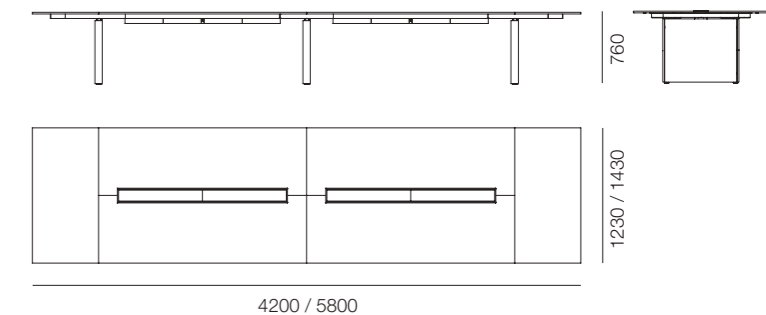

TAVOLO RIUNIONE SAGOMATO
SHAPED MEETING TABLE
TABLE DE RÉUNION EN FORME

IT— Il tavolo riunione sagomato, previsto in due profondità e più lunghezze, ha una struttura composta da due gambe disponibili in legno melaminico, laccato opaco o laccato antigraffio extra opaco soft-touch, Fenix NTM® e impiallacciato. I piani possono essere in legno melaminico, laccato antigraffio extra opaco soft-touch, Fenix NTM® e impiallacciato con spessore di 18/19 mm. Il piano è anche previsto in vetro laccato anti touch e brillante o stampato effetto marmo anti touch e brillante. Il piano in vetro ha spessore totale 18 mm con lastre di 4 mm su supporto melaminico bianco o nero sp.14 mm con bordo in tinta con il piano.

EN— The shaped meeting table, available in two depths and more lengths, has a structure composed of two legs available in melamine wood, matt lacquered or scratch-resistant soft-touch extra matt lacquered, Fenix NTM® and wood veneer. The tops can be made of melamine wood, scratch-resistant soft-touch extra matt lacquered, Fenix NTM® and wood veneer with a thickness of 18/19 mm. The top is also available in anti- touch and brilliant lacquered glass or printed anti touch and brilliant marble effect. The glass top has a total thickness of 18 mm with sheets of 4 mm on a white or black melamine support 14 mm thick with edge matching the top.

F— La table de réunion en forme, disponible en deux profondeurs et plus de longueurs, a une structure composée de deux pieds disponibles en bois mélaminé, laqué mat ou laqué extra mat résistant aux rayures soft-touch, Fenix NTM® et plaqué bois. Les plateaux peuvent être en bois mélaminé, laqué extra mat résistant aux rayures soft-touch soft-touch, Fenix NTM® et plaqué d'une épaisseur de 18/19 mm. Le plateau est également disponible en verre laqué anti empreintes et brillant ou en marbre imprimé à effet anti empreintes et brillant. Le plateau en verre a une épaisseur totale de 18 mm avec des feuilles de 4 mm sur un support en mélamine blanche ou noire de 14 mm d'épaisseur avec un bord assorti au plateau.

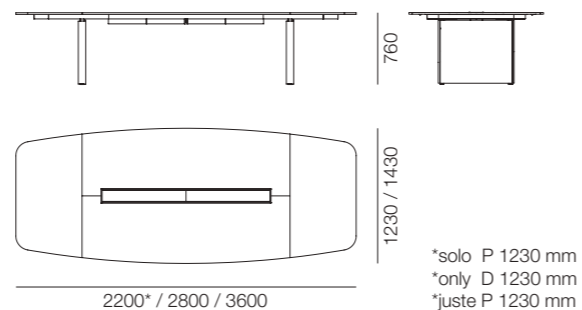

TAVOLO RIUNIONE MODULARE SAGOMATO
SHAPED MODULAR MEETING TABLE
TABLE DE RÉUNION MODULAIRE

IT— Il tavolo riunione modulare è composto da piani componibili in due profondità e più lunghezze con gamba centrale condivisa per la canalizzazione verticale.

EN— The modular meeting table is composed of modular tops in two depths and more lengths with shared central leg for vertical channeling.

F— La table de réunion modulaire est composée de plateaux modulaires en deux profondeurs et plus avec un pied central commun pour la canalisation verticale.

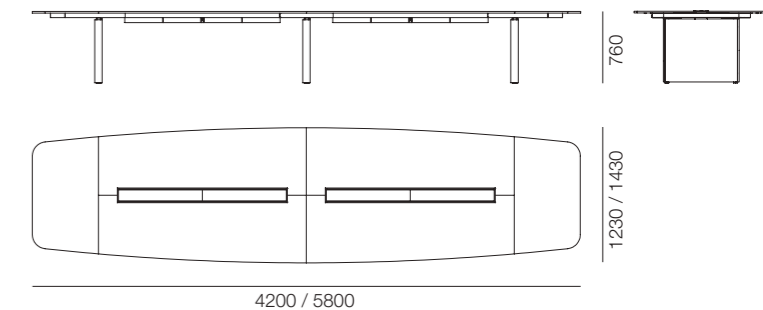

TAVOLI CAFFÈ
COFFEE TABLES
TABLES BASSE

IT— Collezione di tavolini quadrati e rettangolari disponibili in quattro misure, da utilizzare singolarmente o da abbinare tra loro. Hanno struttura e piano sp.18/19 mm disponibili in legno melaminico, laccato antigraffio extra opaco soft-touch, Fenix NTM® e impiallacciato.

EN— Collection of square and rectangular coffee tables available in four sizes, to be used individually or combined with each other. They have structure and top thickness 18/19 mm available in melamine wood, scratch-resistant soft-touch extra matt lacquered, Fenix NTM® and wood veneer.

F— Collection de tables basses carrées et rectangulaires disponibles en quatre tailles, à utiliser individuellement ou à combiner entre elles. Ils ont une structure et un dessus d'épaisseur de 18/19 mm, disponibles en bois mélaminé, en laqué extra mat résistant aux rayures soft-touch, en Fenix NTM® et en plaqué bois.

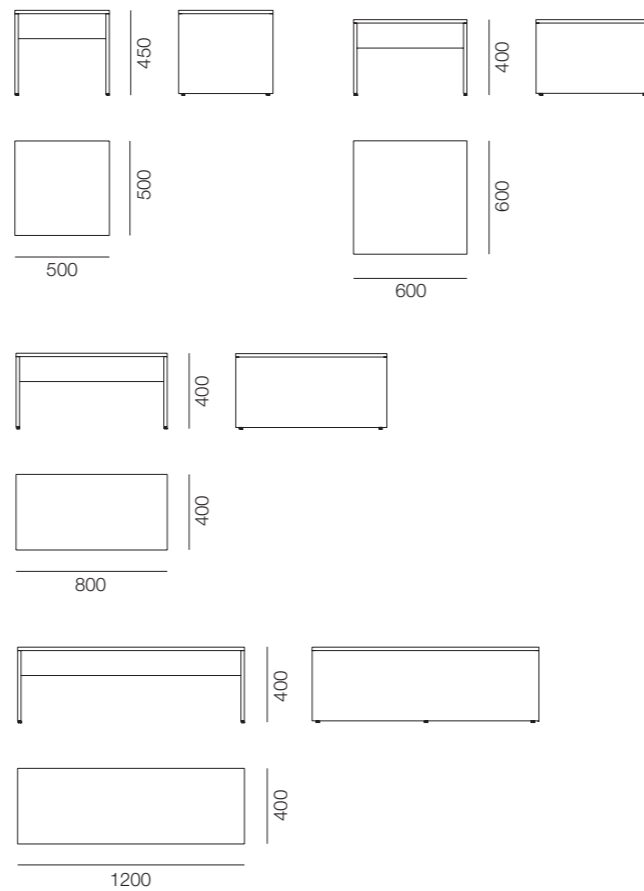

creative & design direction
RMDESIGNSTUDIO / Mariella Vidotti

graphic design & copywriting
RMDESIGNSTUDIO

product design
R&S PROF

photos
concept, set design & styling / RMDESIGNSTUDIO
rendering & styling / SALAPOSA STUDIO

printed in Italy
AGCM / PN
April 2020

L'azienda si riserva in qualunque momento di apportare senza preavviso modifiche a prodotti, accessori e finiture.

The Manufacturer reserves the right to modify products, accessories and finishings at any time without prior notice.

La Société se réserve le droit à tout moment de faire des changements sans préavis aux produits, accessoires et finitions.

Prof srl - Azienda certificata / Certified Company / Entreprise certifiée



PROF

PROF srl
Via Cao de Villa 6/A
Località Falzè di Piave
31020 Senaglia della Battaglia, TV / Italy
T +39 0438 903190 F +39 0438 903228
p.iva / cod.fisc IT03134570260
www.profoffice.it info@profoffice.it

