

ZERO

working system



PR
OF

ZERO

working system

—

**PR
OF**

« CONTENTS »

PAG. 04
CHAPTER 01 - THE COLLECTION

PAG. 06
CHAPTER 02 - THE CATALOGUE

PAG. 08
CHAPTER 03 - PROJECT 01

PAG. 22
CHAPTER 04 - PROJECT 02

PAG. 34
CHAPTER 05 - PROJECT 03

PAG. 46
CHAPTER 06 - PROJECT 04

PAG. 58
CHAPTER 07 - PROJECT 05

PAG. 70
CHAPTER 08 - PROJECT 06

PAG. 84
CHAPTER 09 - TECHNICALS



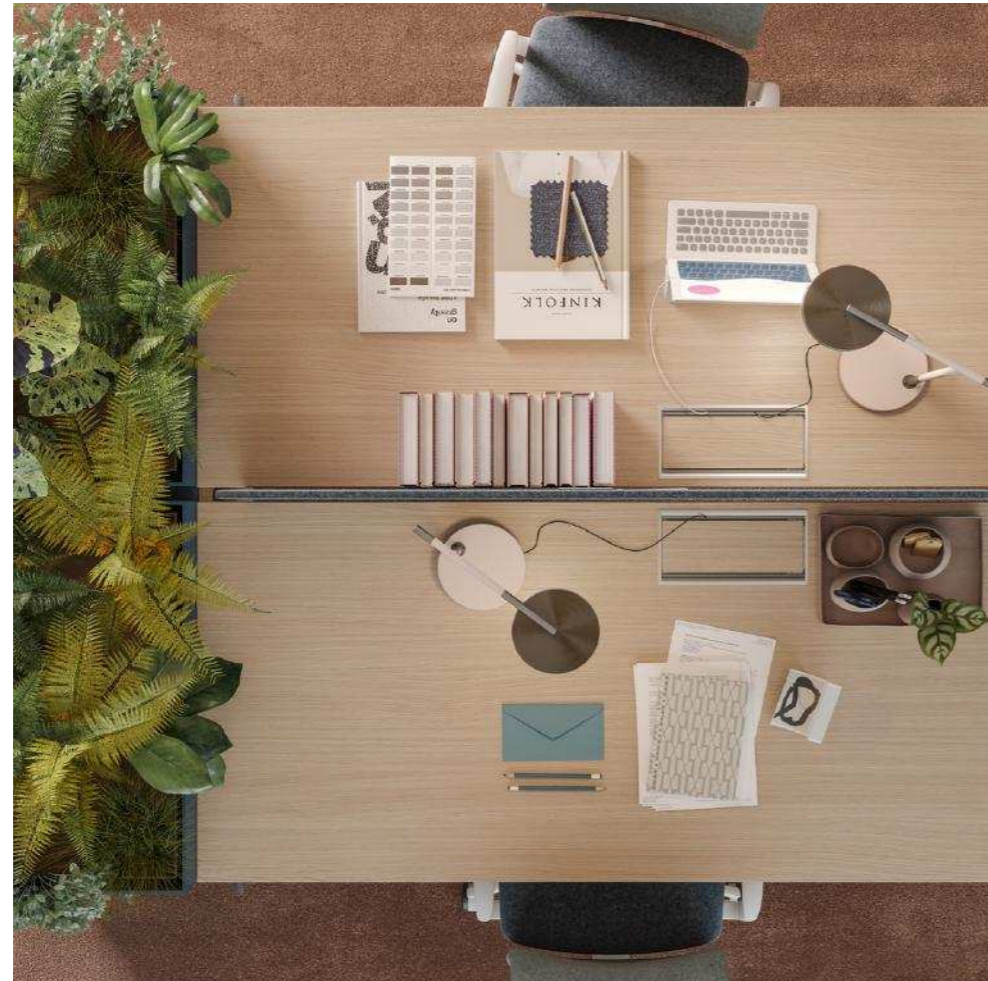

« THE COLLECTION »

IT— ZERO è una collezione di scrivanie dalle linee semplici ed essenziali pensata per rispondere alle esigenze di spazi operativi e manager. Interamente in legno, è disponibile in melaminico, impiallacciato, laccato e Fenix. Il piano è previsto anche in vetro laccato anti touch e brillante in tinta unita o stampato effetto marmo. Dalle postazioni singole in versione MANAGER a quelle aggregate OPERATIVE, la collezione arreda con funzionalità e flessibilità lo spazio di lavoro in ufficio e a casa, interpretando stili e ambientazioni diverse.

I TAVOLI RIUNIONE rettangolari, che condividono il design della collezione Entry, sono previsti in varie profondità e possono essere composti in configurazioni con gamba centrale condivisa.

Completano la collezione una selezione di accessori come gli screen per aumentare il comfort acustico, le cassettiere su ruote e tutte le dotazioni tecnologiche come passacavi e porta cpu. Personalizzano gli ambienti le collezioni di contenitori, mobili di servizio e complementi tutti perfettamente abbinati nei materiali e nelle tonalità.

EN— ZERO is a collection of desks with simple and essential lines designed to meet the needs of operative and managerial spaces. Entirely made of wood, it is available in melamine, veneer lacquered and Fenix. The top is also available in lacquered anti touch and brilliant glass in solid colours or printed with a marble effect. From single workstations in the MANAGER version to OPERATIVE workstations, the collection furnishes the workspace in the office and at home with functionality and flexibility, interpreting different styles and settings.

The rectangular MEETING TABLES, which share the design of the Entry collection, are available in various depths and can be composed in configurations with a shared central leg. The collection is completed by a selection of accessories such as screens to increase acoustic comfort, drawer units on castors and all the technological equipment such as cable tidies and CPU holders. The collections of storage units, service furniture and accessories, all perfectly matched in terms of materials and colours, personalise the rooms.

F— ZERO est une collection de bureaux aux lignes simples et essentielles, conçue pour répondre aux besoins des espaces opérationnels et manager. Entièrement réalisée en bois, elle est disponible en mélamine, en placage, en laqué et en Fenix. Le plan est également disponible en verre laqué anti empreintes et brillant dans des couleurs unies ou imprimées avec un effet marbre. Des postes de travail individuels MANAGER aux postes de travail agrégés SECRÉTAIRE, la collection aménage l'espace de travail au bureau et à la maison avec fonctionnalité et flexibilité, en interprétant différents styles et contextes.

Les TABLES DE RÉUNION rectangulaires, qui partagent le design de la collection Entry, sont disponibles en différentes profondeurs et peuvent être composées dans des configurations avec un pied central commun. La collection est complétée par une sélection d'accessoires tels que des écrans pour augmenter le confort acoustique, des cassoins tiroirs sur roulettes et tous les équipements technologiques tels que les passe-câbles et les port cpu. Les collections de meubles de rangement, de meubles de service et d'accessoires, toutes parfaitement assorties en termes de matériaux et de couleurs, personnalisent les pièces.

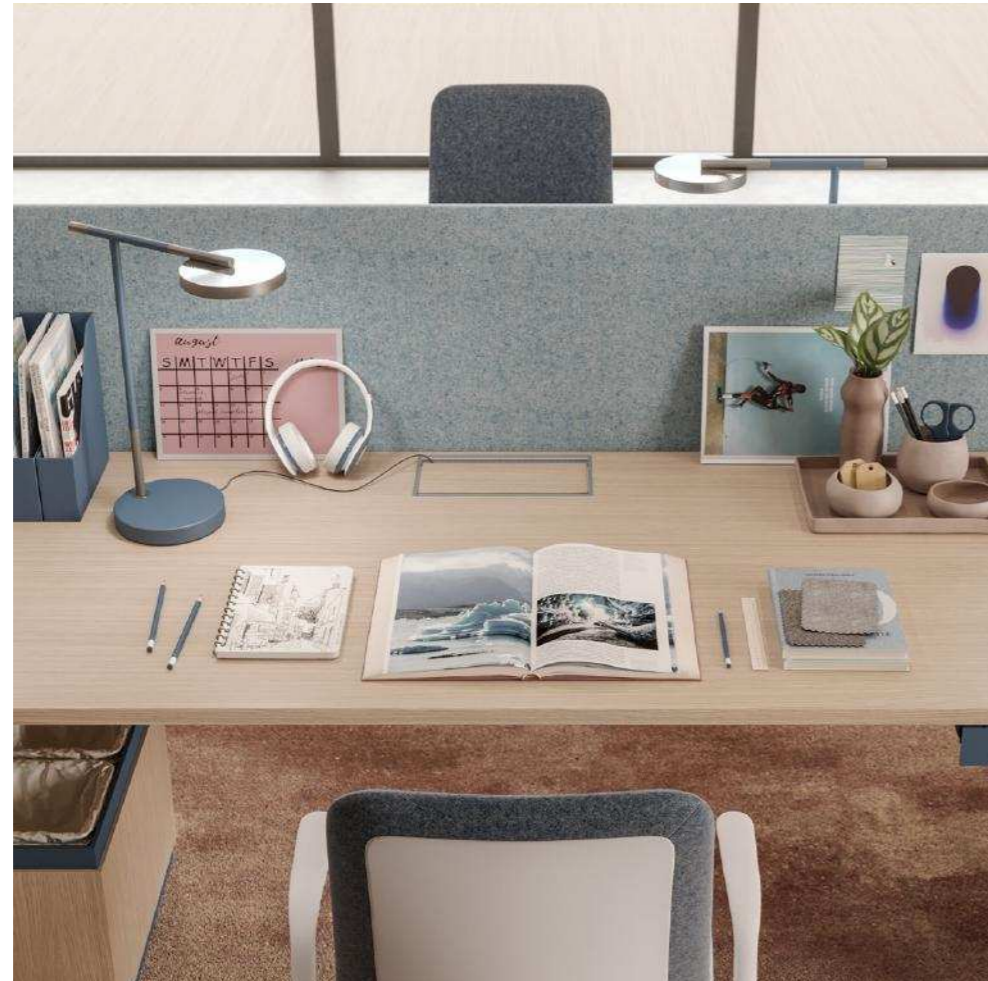

« THE CATALOGUE »

IT— Un racconto inedito che esplora la collezione ZERO attraverso un'ampia galleria di immagini ambientate, caratterizzate da armonia tra le tonalità ed eleganza degli abbinamenti. Sei progetti per ispirare e soddisfare i gusti eterogenei di un pubblico contemporaneo. Spazi operativi e manager che interpretano alcune delle molte potenzialità espressive del sistema, contraddistinto da una grande versatilità compositiva e una vasta gamma di materiali e finiture. A seguire un'accurata sezione illustrata con immagini still life, disegni tecnici e la selezione delle finiture.

EN— An unedited story exploring the ZERO collection through a wide gallery of images set, characterised by the harmony of the shades and the elegance of the combinations. Six projects to inspire and satisfy the heterogeneous tastes of a contemporary public. Operative and managerial spaces featuring some of many expressive potentials of the system, characterised by great compositional versatility and a wide range of materials and finishes. This is followed by a carefully illustrated section with still life images, technical drawings and a selection of finishes.

F— Une histoire inédite qui explore la collection ZERO à travers une vaste galerie d'images mises en scène, caractérisées par l'harmonie entre les teintes et l'élégance des combinaisons. Six projets pour inspirer et satisfaire les goûts hétérogènes d'un public contemporain. Espaces secrétaire et manager qui interprètent quelques-unes des nombreuses potentialités expressives du système, qui se distingue par une grande versatilité de composition et une large gamme de matériaux et de finitions. Elle est suivie d'une section illustrée avec précision, comprenant des images still life, des dessins techniques et une sélection de finitions.

Project 01 Working

rovere natural / blue sea / bianco
 natural oak / blue sea / white
 chêne naturel / bleue mer / blanc

IT— Configurazione con scrivanie condivise a bench in versione rovere natural. Sono attrezzate con screen divisori Front fabric in tessuto di lana color cielo e carta da zucchero, cassetto metallico Smart tray color blue sea, gettacarte Square in melaminico rovere natural e blue sea, contenitori Profslide ad altezza scrivania con ante scorrevoli e Box porta piante in melaminico blue sea. A parete, un mobile scorrevole Profslide a quattro ante in finitura melaminico blue sea con maniglie in tinta e dalla parte opposta in melaminico bianco con maniglie in tinta ed ante in melaminico rovere natural. Ampia la selezione di complementi che arredano e personalizzano lo spazio di lavoro, come le lampade, i set scrivania e i vasi.

EN— Configuration with shared bench desks in natural oak. They are equipped with Front fabric divider screens in sky and sugar paper wool fabric, Smart tray metal drawer in blue sea, Square waste paper basket in natural oak and blue sea melamine, Profslide desk-height storage units with sliding doors and a blue sea melamine plant Box. On the wall, a Profslide sliding cabinet with four doors in blue sea melamine finish with matching handles and on the opposite side in white melamine with matching handles and doors in natural oak melamine. There is a wide selection of accessories that furnish and personalise the work space, such as lamps, desk sets and vases.

F— Configuration avec bureaux partagés en version chêne naturel. Ils sont équipés de écran de séparation Front fabric en tissu de laine ciel et papier sucre, d'un tiroir Smart en métal bleue mer, d'une corbeille à papier Square en chêne naturel et mélamine bleue mer, de rangements Profslide à hauteur de bureau avec des portes coulissantes et un porte-plante Box en mélamine bleue mer. Au mur, un meuble coulissant Profslide avec quatre portes en mélaminé bleue mer avec poignée assortie et de l'autre côté, un en mélaminé blanc avec poignées assorties et des portes en mélaminé chêne naturel. Il existe un large choix d'accessoires qui meublent et personnalisent l'espace de travail, tels que des lampes, des set de bureau et des vases.

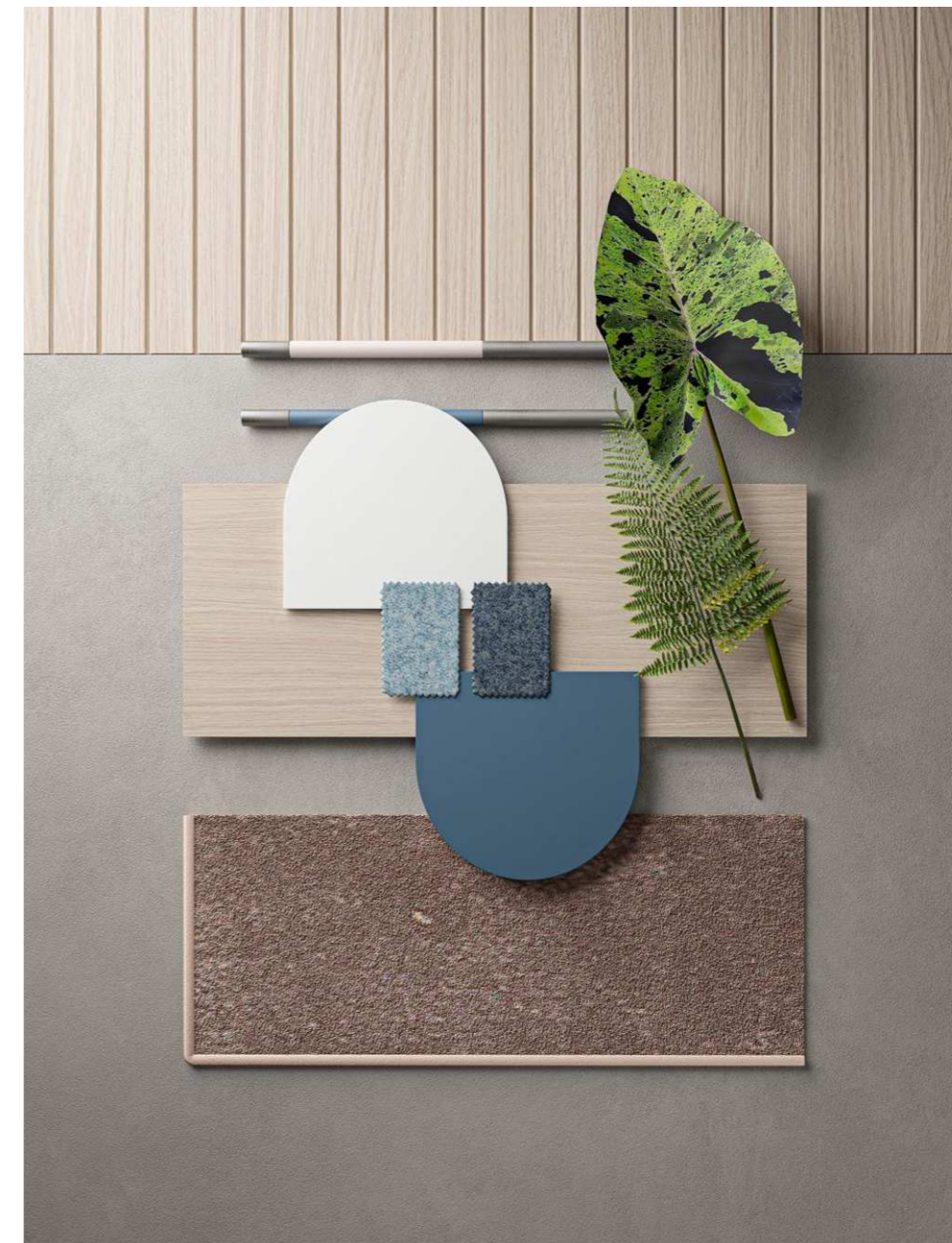









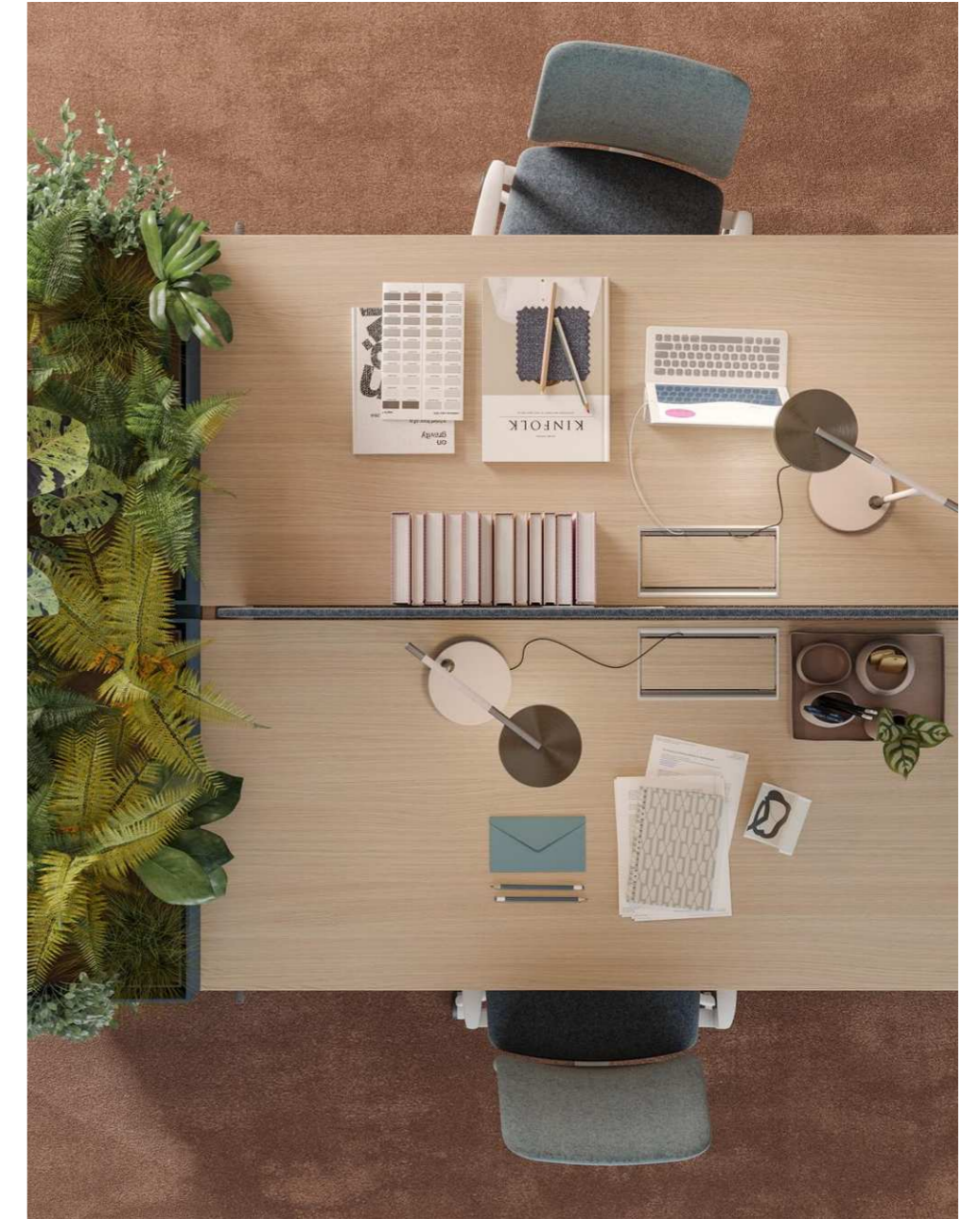
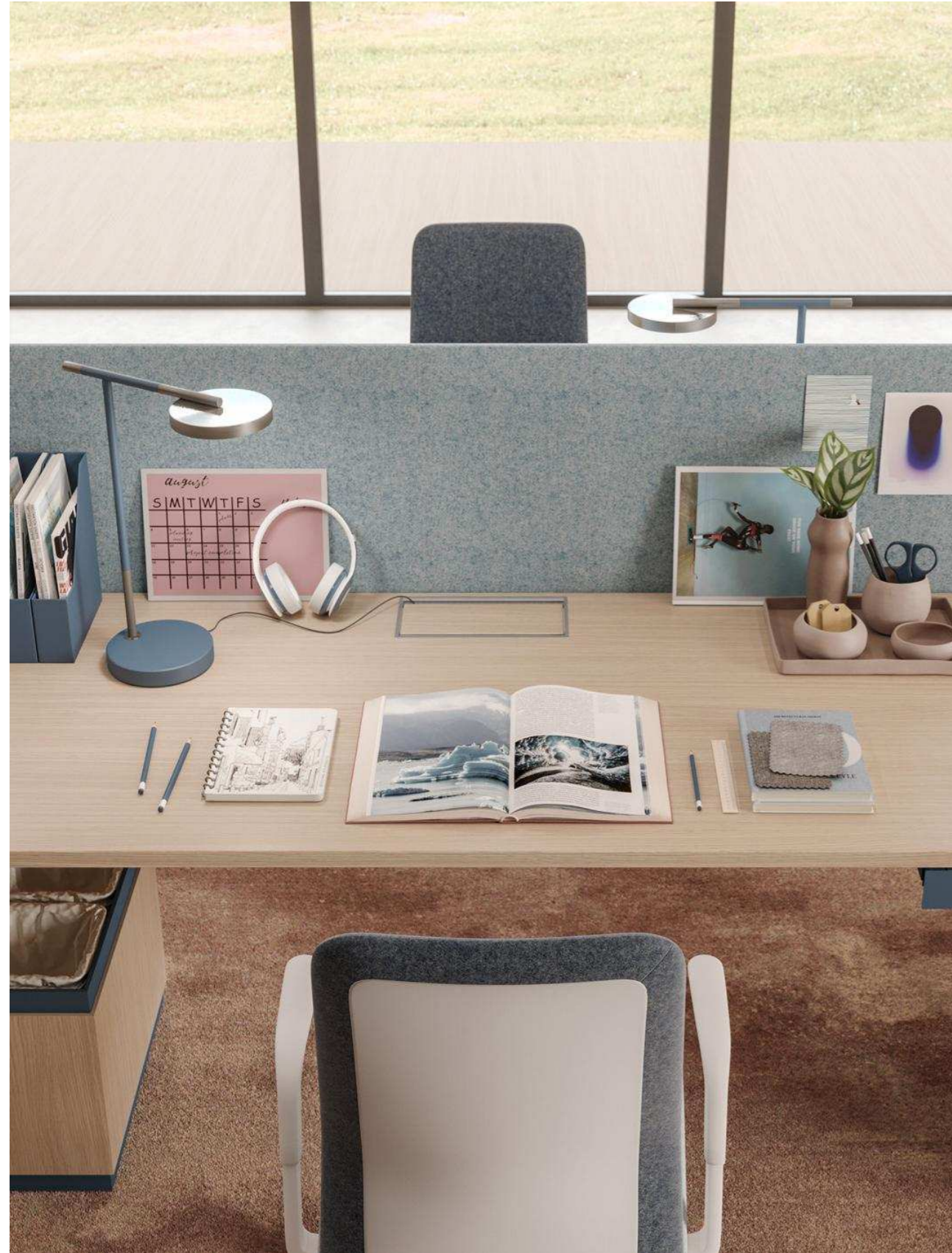



Project 02 Working

bianco / nero
white / black
blanc / noir

IT— Configurazione con doppie postazioni condivise in melaminico bianco, separate da screen Front fabric in tessuto di lana color terra e basalto. Come complementi, cassettiere su ruote Easy in melaminico nero e gettacarte Square in melaminico bianco e nero. Arredano le scrivanie le lampade da tavolo della collezione Alice e i set scrivania Sophie. Nel fondo, un armadio Profbox in melaminico giocato nelle tonalità bianco e nero. Il tavolo riunione modulare è in finitura melaminico bianco, abbinato ai contenitori Profbox con ante push to open e vani a giorno in melaminico bianco e nero. A lato, il portabiti Jane in versione bianca e le fioriere Sessanta in melaminico bianco e nero. Sopra il tavolo due grandi lampade sospese della collezione Alice.

EN— Configuration with shared double workstations in white melamine, separated by Front fabric screen in wool fabric in ground and basalt colours. Complementary items include Easy drawer units on castors in black melamine and Square wastepaper bin in black and white melamine. The desks are furnished with table lamps from the Alice collection and Sophie desk sets. In the background, a Profbox cabinet in black and white melamine. The modular meeting table is in white melamine finish, combined with Profbox storage units with push to open doors and open compartments in black and white melamine. To the side, the Jane clothes stand in white color and the Sessanta planters in black and white melamine. Above the table two big suspended lamps from the Alice collection.

F— Configuration avec doubles postes de travail partagés en mélamine blanche, séparés par deux écran Front fabric en tissu de laine dans les couleurs terre et basalte. Les éléments complémentaires sont les caissons tiroirs sur roulettes Easy en mélamine noire et la corbeille à papier Square en mélamine noire et blanche. Les bureaux sont équipés de lampes de table de la collection Alice et d'ensembles de bureau Sophie. En arrière-plan, un meuble Profbox en mélaminé noir et blanc. La table de réunion modulaire est en finition mélaminée blanche, combinée à des unités de rangement Profbox avec portes push to open et compartiments ouverts en mélamine noire et blanche. Sur le côté, le portemanteau Jane en blanc et les planters Sessanta en mélamine noire et blanche. Au-dessus de la table, deux grandes lampes suspendues de la collection Alice.

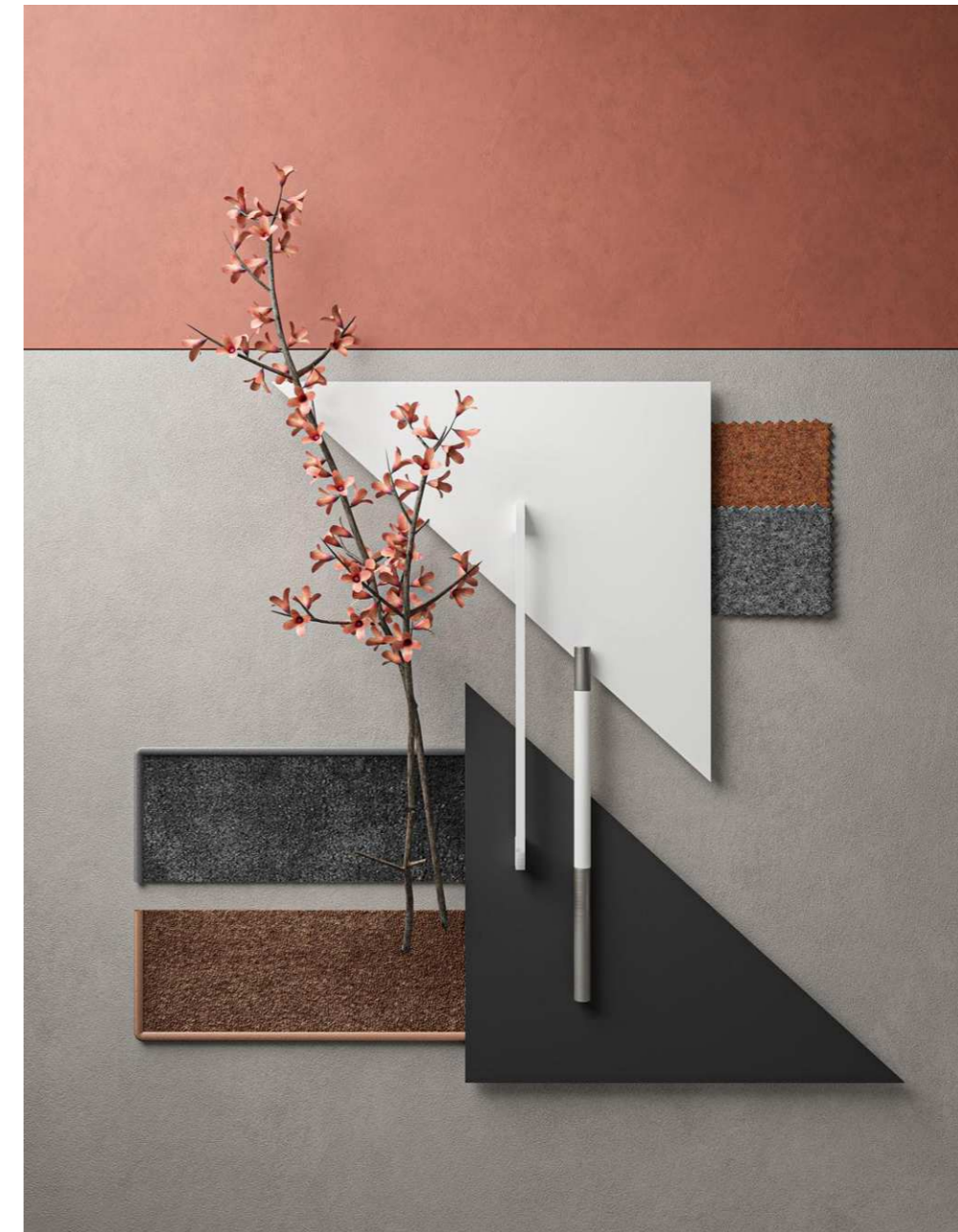



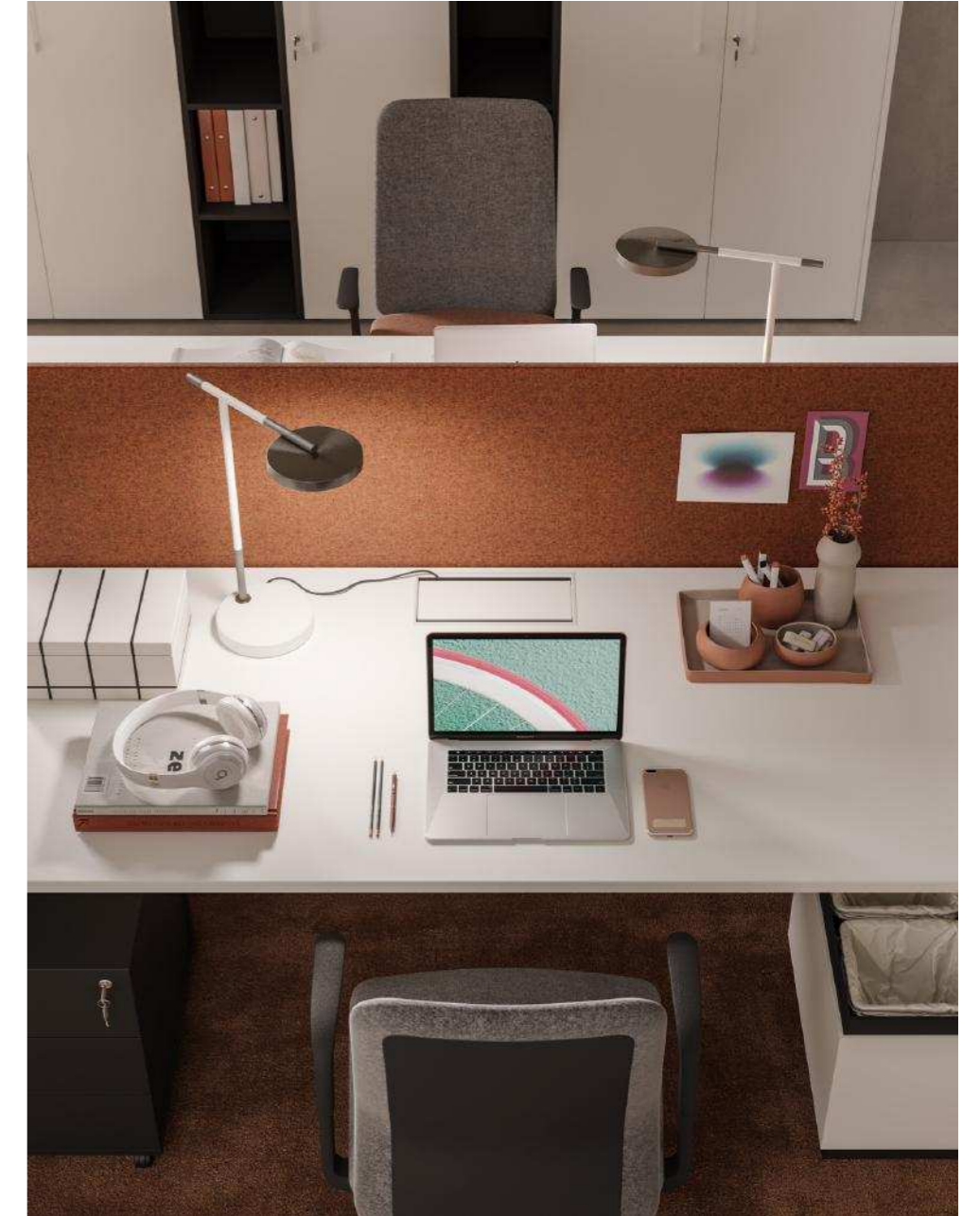







Project 03 working

bianco / senape
white / mustard
blanc / moutarde

IT— Composizione con paretina divisoria Openwall e postazioni con dattilo e cassettera portante. Le scrivanie sono in finitura melaminico bianco, le paretine hanno il profilo metallico bianco e i pannelli in melaminico bianco e tessuto di lana nei colori curry, arancio e cielo. Come complementi, il gettacarte Square in melaminico bianco e senape, le lampade da tavolo Alice e i set scrivania Sophie. A parete, il mobile Profslide in melaminico bianco con maniglie in tinta, l'appendiabiti Jane bianco e la fioriera Sessanta in melaminico bianco e senape.

EN— Composition with Openwall partition and workstations with extension and drawer unit. The desks have a white melamine finish, the partitions have a white metal profile and panels in white melamine and wool fabric in curry, orange and sky colours. As complements, the Square waste paper bin in white and mustard melamine, the Alice table lamps and the Sophie desk sets. On the wall, the Profslide cabinet in white melamine with matching handles, the Jane white coat rack and the Sessanta planter in white melamine and mustard.

F— Composition avec cloison Openwall et postes de travail avec retour et meuble à tiroirs. Les bureaux ont une finition en mélaminé blanc, les cloisons ont un profilé métallique blanc et des panneaux en mélaminé blanc et tissu de laine dans les couleurs curry, orange et ciel. Les articles complémentaires comprennent la corbeille à papier Square en mélamine blanche et moutarde, les lampes de table Alice et les set de bureau Sophie. Au mur, le meuble Profslide en mélaminé blanc avec poignées assorties, le porte-manteau Jane blanc et la planter Sessanta en mélaminé blanc et moutarde.













Project 04 Manager

nero / bianco
black / white
noir / blanc

IT— La scrivania con dattilo in versione manager è proposta in unica finitura Fenix nero. La arredano la lampada da tavolo Alice, il set scrivania Sophie e il gettacarte Square in melaminico bianco e nero. Nel fondo, due contenitori Profbox con ante push to open e moduli a giorno nelle finiture melaminico bianco e nero.

Il tavolo riunioni è in Fenix nero abbinato ad un contenitore Profbox con ante push to open e moduli a giorno in melaminico bianco e nero. A lato, l'appendiabiti Jane in colore terra e la fioriera Sessanta in melaminico bianco e nero. Sopra il tavolo due coppie di lampade sospese della collezione Alice in colore nero.

EN— The desk with extension in manager version is offered in a single black Fenix finish. It is furnished with the Alice table lamp, the Sophie desk set and the Square waste paper in black and white melamine.

In the back, two Profbox storage units with push to open doors and open modules in black and white melamine. The meeting table is in black Fenix combined with a Profbox storage unit with push to open doors and open modules in black and white melamine finish. To the side, the Jane coat stand in ground colour and the Sessanta planter in black and white melamine. Above the table, two pairs of suspended lamps from the Alice collection in black color.

F— Le bureau avec extension en version manager est proposé dans une seule finition Fenix noir. Il est meublé avec la lampe de table Alice, le set de bureau Sophie et la corbeille à papier Square en mélamine noire et blanche. À l'arrière, deux meubles de rangement Profbox avec des portes à ouverture automatique et des modules ouverts en mélaminé noir et blanc.

La table de réunion est en Fenix noir combiné à un meuble de rangement Profbox avec des portes push to open et des modules ouverts en mélaminé noir et blanc. Sur le côté, le porte-manteau Jane en couleur terre et le bac à plantes Sessanta en mélamine noir et blanc. Au-dessus de la table, deux paires de lampes suspendues de la collection Alice en noir.













Project 05 Manager

beige / noce dark / tabacco
 beige / dark walnut / tobacco
 beige / noyer foncé / tabac

IT— La scrivania in versione manager è proposta con dattilo nella combinazione di finiture melaminico beige e noce dark. Sul piano, un sottomano Skin in cuoietto colore nero, un set scrivania Sophie e una lampada da tavolo Alice in colore nero. A terra, una cassetiera su ruote Easy in melaminico beige e un gettacarte Square in melaminico beige e noce dark. Nel fondo, un mobile Profbox in melaminico tabacco con maniglie in tinta. Nell'area attesa, due tavoli caffè nei colori melaminico beige e noce dark e a parete due lampade della collezione Alice. Il tavolo riunione è presentato in melaminico beige e noce dark con abbinato un mobile Profbox in finitura melaminico tabacco con vani a giorno noce dark. Sopra il tavolo e il mobile, lampade della collezione Alice.

EN— The desk in the manager version is offered with extension in a combination of beige melamine and dark walnut finishes. On the top there is a Skin hunderhand in black leather, a Sophie desk set and an Alice table lamp in black. On the floor, an Easy drawer unit on castors in beige melamine and a Square waste paper in beige melamine and dark walnut. In the back, a Profbox cabinet in tobacco melamine with matching handles. In the waiting area there are two coffee tables in beige melamine and dark walnut and on the wall two lamps from the Alice collection. The meeting table is presented in beige melamine and dark walnut with a matching Profbox cabinet in tobacco melamine finish with dark walnut open compartments. Above the table and the cabinet, lamps from the Alice collection.

F— La version manager du bureau est disponible avec le extension dans une combinaison de finitions en mélamine beige et en noyer foncé. Sur le dessus, on trouve un sous main Skin en cuir noir, un set de bureau Sophie et une lampe de table Alice en noir. Au sol, un meuble à tiroirs sur roulettes Easy en mélamine beige et une corbeille à papier Square en mélamine beige et noyer foncé. Au fond, un meuble Profbox en mélaminé tabac avec des poignées assorties. Dans la salle d'attente, deux tables basses en mélamine beige et noyer foncé et deux lampes de la collection Alice au mur. La table de réunion est présentée en mélamine beige et en noyer foncé avec un meuble Profbox assorti en finition mélamine tabac avec des compartiments ouverts en noyer foncé. Au-dessus de la table et du meuble, des lampes de la collection Alice.













Project 06 Manager

noce natural / terra / verde bosco
 natural walnut / ground / forest green
 noyer naturelle / terre / vert forêt

IT— La scrivania manager è proposta con dattilo in finitura melaminico noce natural. Sul piano trova spazio un set scrivania Sophie e una lampada da tavolo Alice. A terra, il mobile di servizio su ruote Store laccato opaco color terra. Nel fondo, due mobili Profbox in finitura laccato verde bosco con maniglia a gola metallica in tinta. Nell'area meeting, un tavolo della collezione Table con piano in melaminico noce natural e struttura laccata ottone. Sopra il tavolo, lampade della collezione Alice color terra. Dietro, un mobile Profbox in finitura laccato terra con maniglia a gola metallica in tinta e una fioriera Sessanta in melaminico noce natural e laccato terra.

EN— The Manager desk is offered with an extension in natural walnut melamine finish. On the top there is a Sophie desk set and an Alice table lamp. On the floor, the Store ground lacquered service unit on castors. In the back, two Profbox cabinets in a forest green matt lacquered finish with matching groove metal handle. In the meeting area, a table from the Table collection with a natural walnut melamine top and brass lacquered structure. Above the table, lamps from the Alice collection in ground colour. Behind, a Profbox cabinet in ground lacquered finish with matching groove metal handle and a Sessanta planter in natural walnut melamine and ground lacquered finish.

F— Le bureau du manager est proposé avec le retour en finition mélaminée noyer naturelle. En haut, il y a un ensemble de bureau Sophie et une lampe de table Alice. Au sol, le Store, unité de service sur roulettes de couleur terre laqué. À l'arrière, deux armoires Profbox en finition laquée vert forêt avec poignée en métal à rainure assortie. Dans la zone de réunion, une table de la collection Table avec plateau en mélaminé noyer naturelle et structure laquée laiton. Au-dessus de la table, des lampes de la collection Alice en couleur terre. Derrière, un meuble Profbox en finition laquée terre avec poignée métallique à rainure assortie et un bac à plantes Sessanta en mélamine noyer naturelle et finition laquée terre.

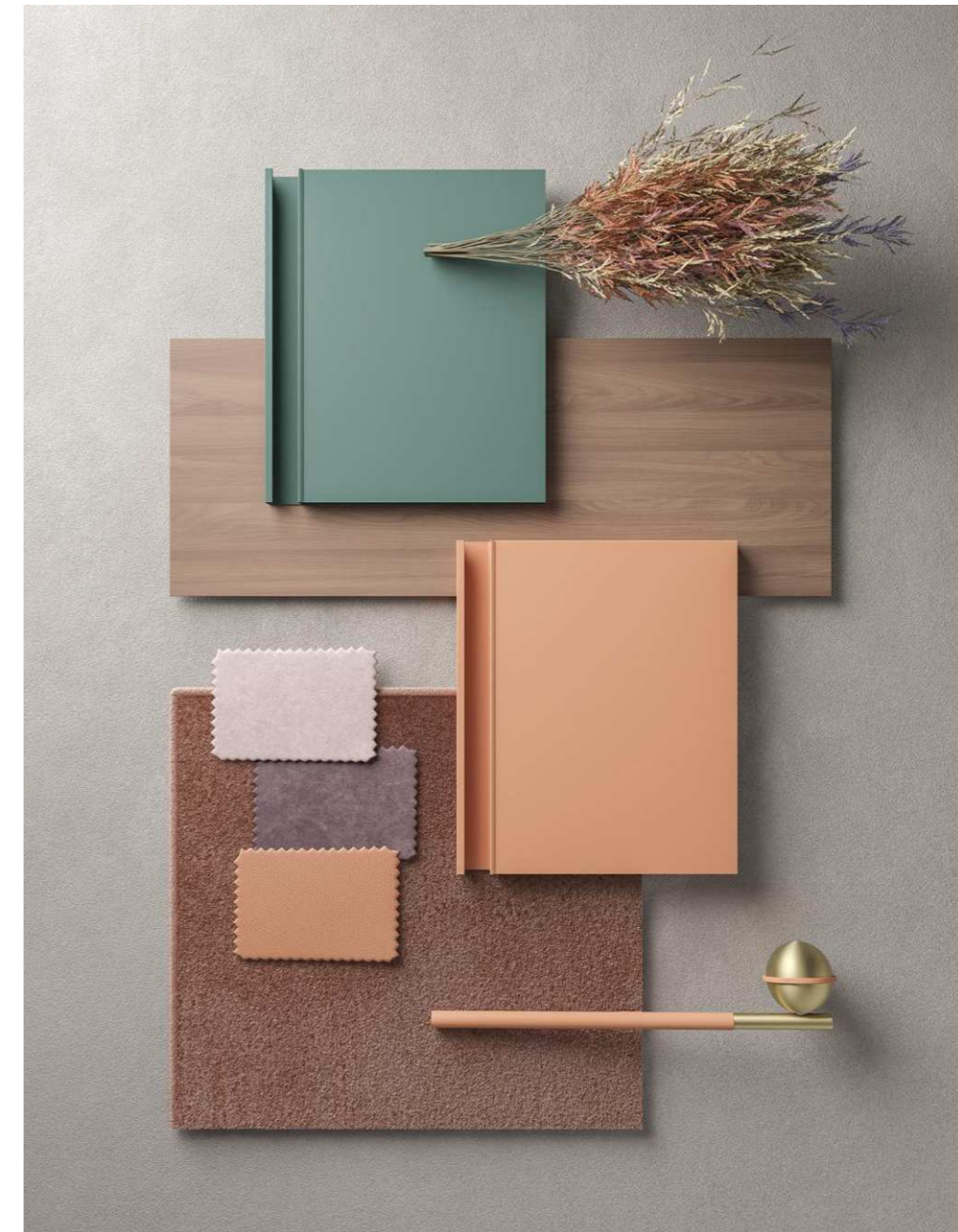











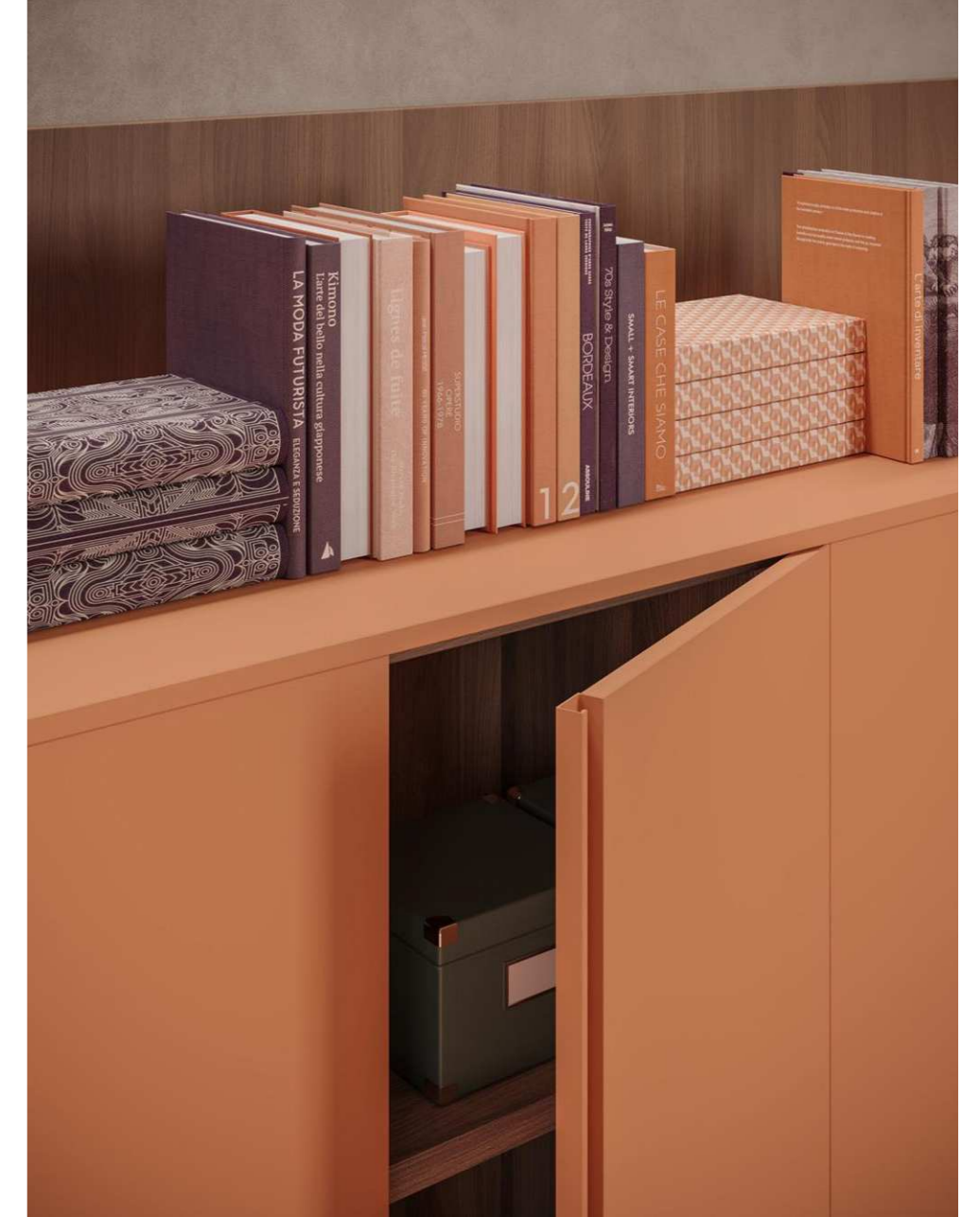
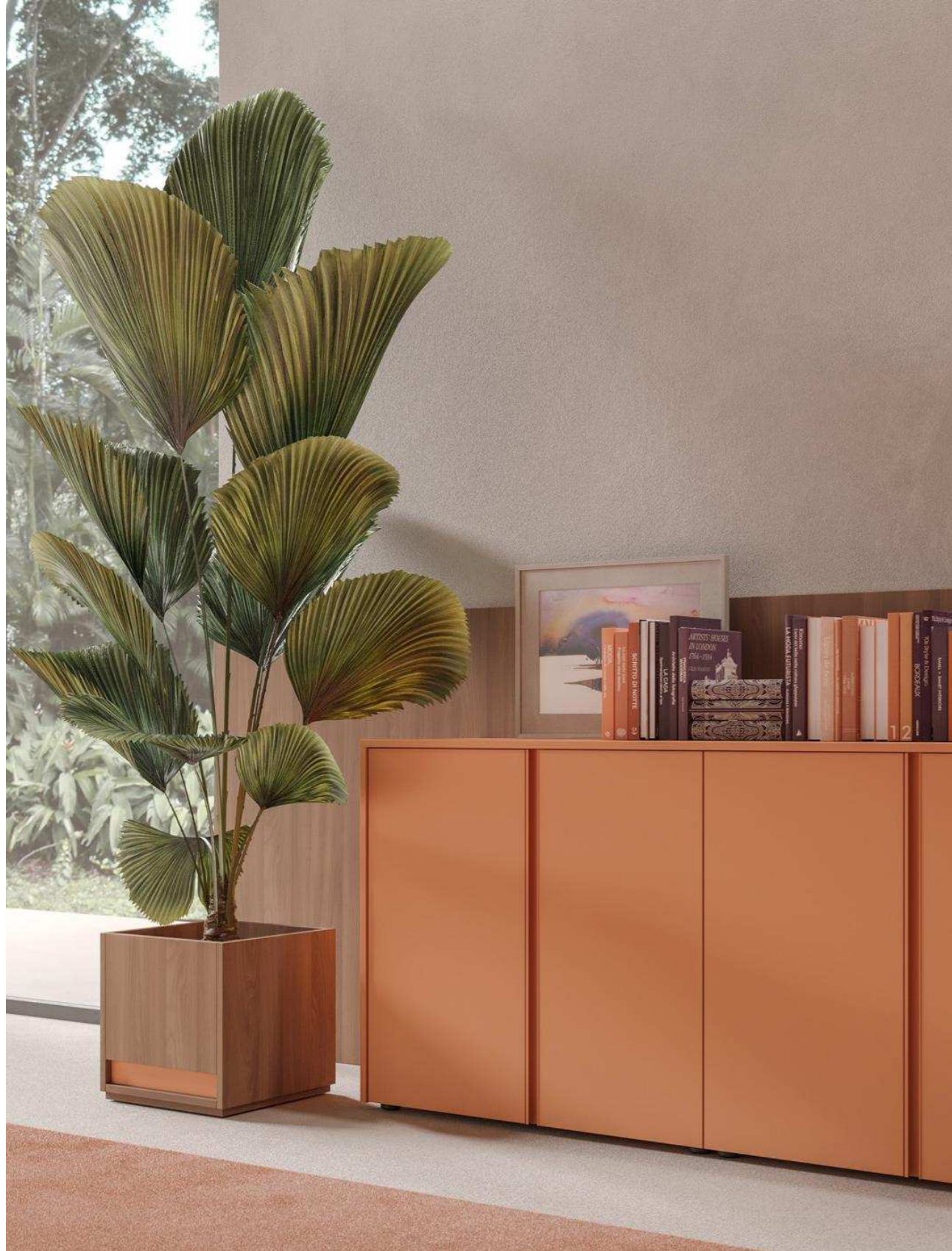



« TECHNICALS »

IM - IMPIALLACCIATO LEGNO / WOOD VENEER / PLAQUÉ BOIS



V71M
rovere natural
natural oak
chêne naturel

V44M
noce Canaletto
walnut Canaletto
noyer Canaletto

V50M
rovere termotrattato
thermotreated oak
chêne traité thermiquement

V48M
ebano Makassar
ebony Makassar
ébène Makassar

FX - FENIX NTM® / FENIX NTM® / FENIX NTM®

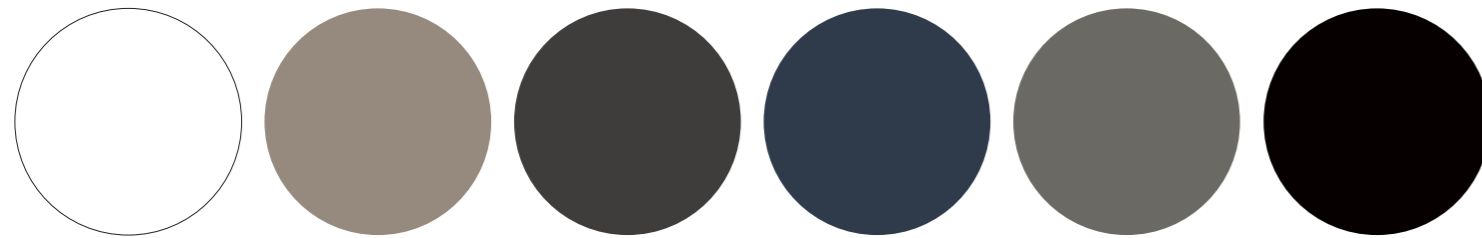

F032
bianco
white
blanc

F717
castoro
beaver
castor

F749
cacao
cocoa
cacao

F754
blu scuro
dark blue
bleu foncé

F718
grigio Londra
London grey
gris Londres

F720
nero
black
noir

ME - MELAMINICO / MELAMINE / MÉLAMINÉ



M71W
rovere natural
natural oak
chêne naturel

M75W
noce natural
natural walnut
noyer naturelle

M77W
noce dark
dark walnut
noyer foncé

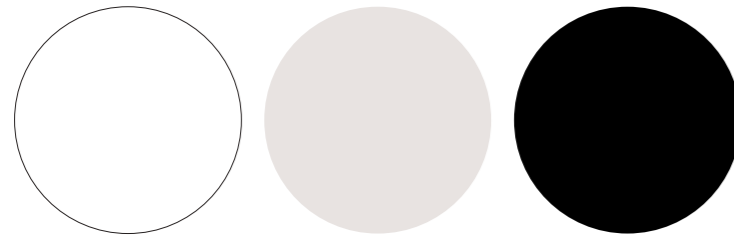

M200
bianco
white
blanc

M010
grigio chiaro
light grey
gris clair

M040
nero
black
noir

MC - COLORE MELAMINICO / MELAMINE COLOR / COULEUR MÉLAMINÉE

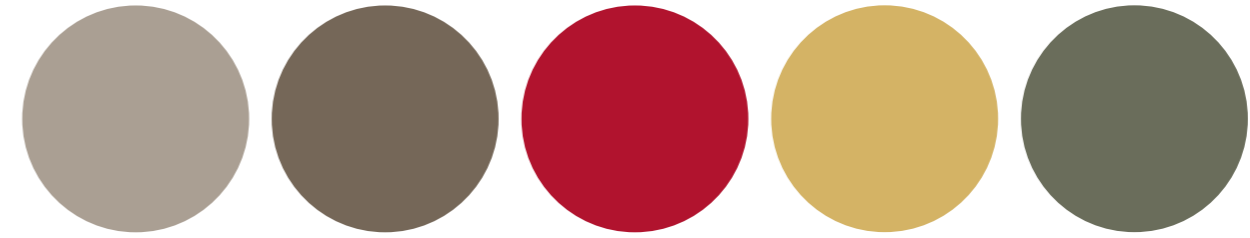

C260
beige
beige
beige

C250
tabacco
tobacco
tabac

C290
rosso oriente
orient red
rouge orient

C390
senape
mustard
moutarde

C240
verde oliva
olive green
vert olive

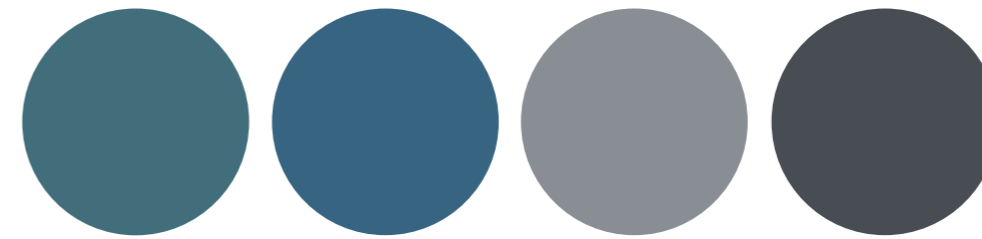

C330
petrolio
petroleum
pétrole

C350
blue sea
blue sea
bleue mer

C340
grigio perla
pearl grey
gris perle

C300
basalto
basalt
basalte

SB - VETRO STAMPATO BRILLANTE / BRILLIANT PRINTED GLASS / VERRE IMPRIMÉ BRILLANT

SA - VETRO STAMPATO ANTI TOUCH / ANTI TOUCH PRINTED GLASS / VERRE IMPRIMÉ ANTI EMPREINTES



P0770B
P0770A
Calacatta oro
Calacatta gold
Calacatta or

P2069B
P2069A
Emperador dark
Emperador dark
Emperador dark

P1944B
P1944A
stone grey
stone grey
stone grey

P1377B
P1377A
nero Marquina
black Marquina
noir Marquina

OS - ALLUMINIO OSSIDATO / OXIDIZED ALUMINIUM / ALUMINIUM OXYDÉ



OB7S
ottone spazzolato
brushed brass
laiton brossé

OASC
alluminio spazzolato
brushed aluminum
aluminium brossé

OE8S
nero spazzolato
brushed black
noir brossé

VB - VETRO LACCATO BRILLANTE / BRILLIANT LACQUERED GLASS / VERRE LAQUÉ BRILLANT
VA - VETRO LACCATO ANTI TOUCH / ANTI TOUCH LACQUERED GLASS / VERRE LAQUÉ ANTI EMPREINTES

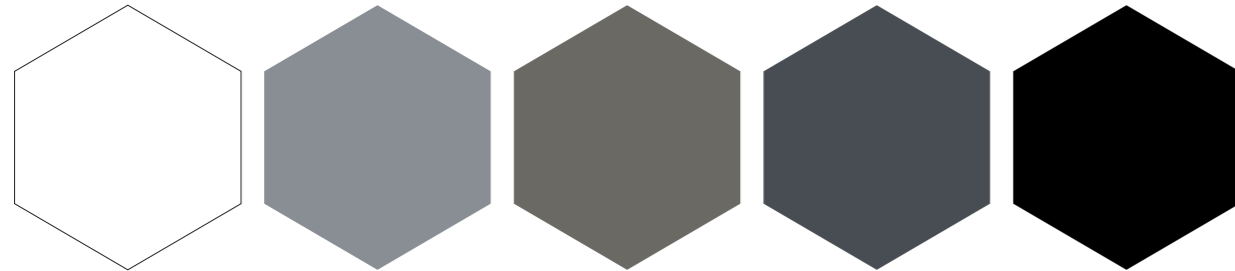

Q9010B Q9010A bianco white blanc	Q7045B Q7045A grigio perla pearl grey gris perle	Q7030B Q7030A grigio Londra London grey gris Londres	Q7500B Q7500A basalto basalt basalte	Q9005B Q9005A nero black noir
--	--	--	--	---

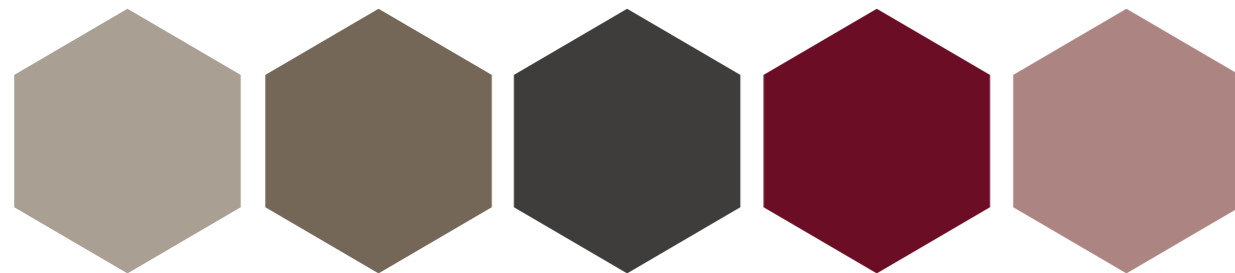

Q3047B Q3047A beige beige beige	Q6005B Q6005A tabacco tobacco tabac	Q8019B Q8019A cacao cocoa cacao	Q3004B Q3004A rosso rubino ruby red rouge rubis	Q4020B Q4020A desert rose desert rose desert rose
---	---	---	---	---

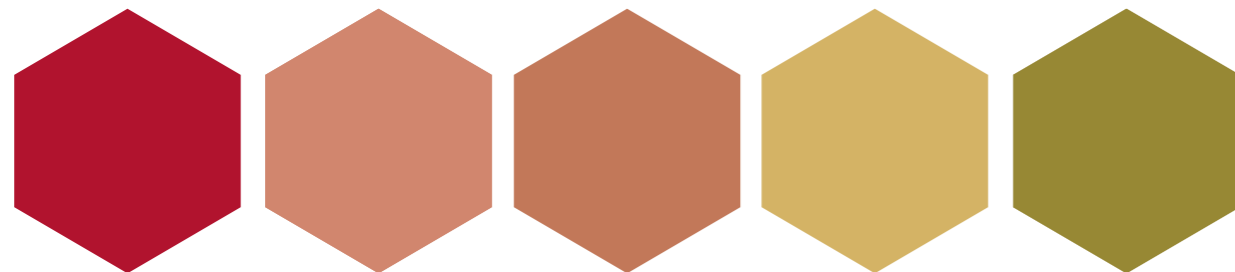

Q3031B Q3031A rosso oriente orient red rouge orient	Q3012B Q3012A rame copper cuivre	Q3040B Q3040A terra ground terre	Q0039B Q0039A senape mustard moutarde	Q4050B Q4050A verde pistacchio pistachio green vert pistache
---	--	--	---	--



Q7003B Q7003A verde oliva olive green vert olive	Q7010B Q7010A verde bosco forest green vert forêt	Q0033B Q0033A petrolio petroleum pétrole	Q6020B Q6020A blue sea blue sea bleue mer	Q5011B Q5011A blu scuro dark blue bleu foncé
--	---	--	---	--

MO - METALLO VERNICIATO OPACO / MATT VARNISHED METAL / MÉTAL VERNI MAT



E90100 bianco white blanc	E70470 grigio chiaro light grey gris clair	E70450 grigio perla pearl grey gris perle	E7030M grigio Londra London grey gris Londres	E7500M basalto basalt basalte	E90050 nero black noir
---	--	---	---	---	--



E3047M beige beige beige	E70480 castoro beaver castor	E80190 cacao cocoa cacao	E10360 ottone brass laiton
--	--	--	--

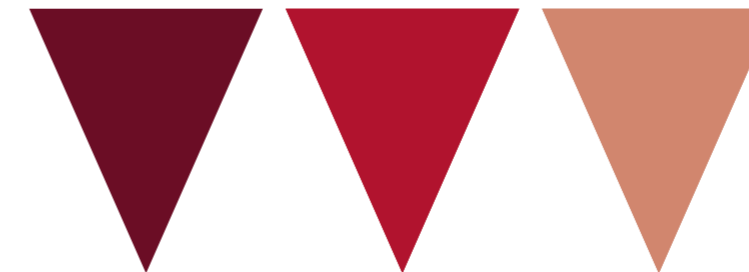

E30040 rosso rubino ruby red rouge rubis	E30310 rosso oriente orient red rouge orient	E30120 rame copper cuivre
--	--	---



E70030 verde oliva olive green vert olive	E0033M petrolio petroleum pétrole	E50110 blu scuro dark blue bleu foncé
---	---	---

LA - LACCATO OPACO PLUS
MATT LACQUERED PLUS
LAQUÉ MAT PLUS

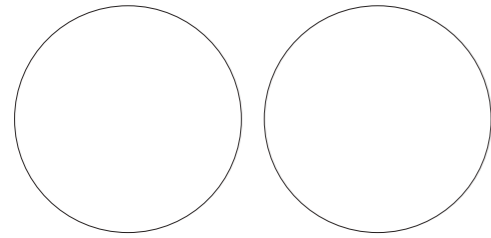

D9016M
 bianco neve
 snow white
 blanche neige

D9010M
 bianco
 white
 blanc

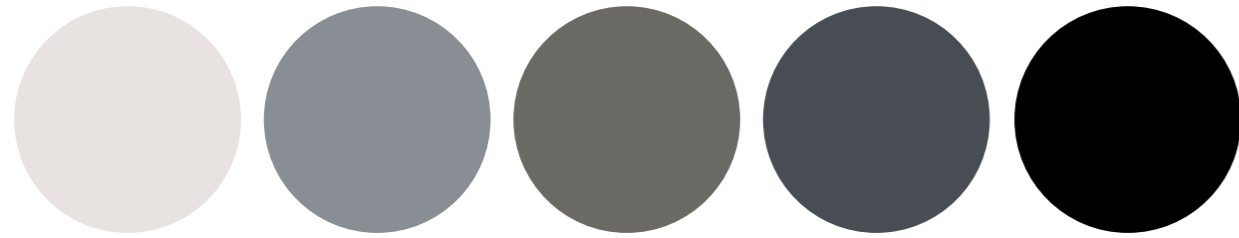

D1500M
 grigio chiaro
 light grey
 gris clair

D4500M
 grigio perla
 pearl grey
 gris perle

D7030M
 grigio Londra
 London grey
 gris Londres

D7500M
 basalto
 basalt
 basalte

D9005M
 nero
 black
 noir

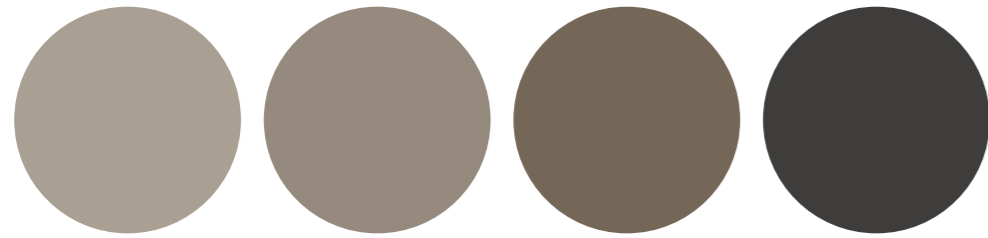

D3005M
 beige
 beige
 beige

D7048M
 castoro
 beaver
 castor

D6005M
 tabacco
 tobacco
 tabac

D7502M
 cacao
 cocoa
 cacao

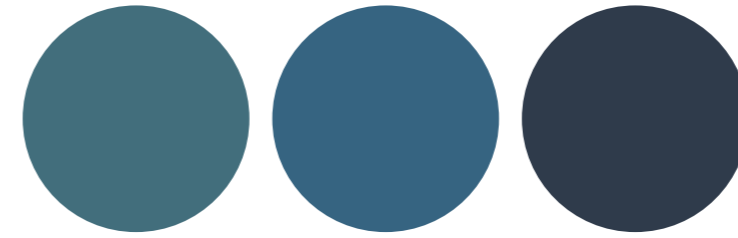

D5020M
 petrolio
 petroleum
 huile

D6020M
 blue sea
 blue sea
 bleue mer

D5011M
 blu scuro
 dark blue
 bleu foncé

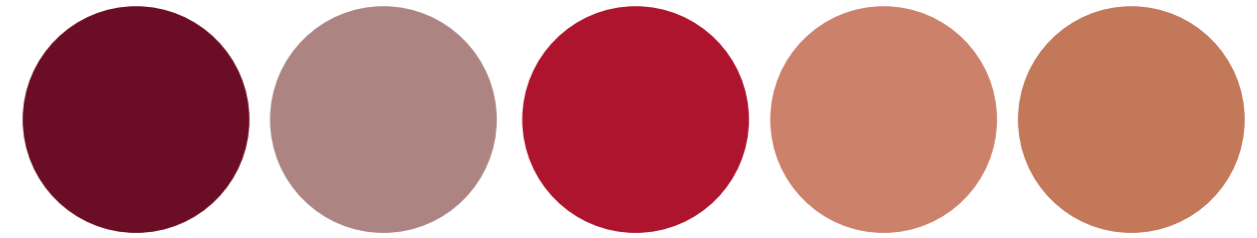

D3004M
 rosso rubino
 ruby red
 rouge rubis

D4020M
 desert rose
 desert rose
 desert rose

D2070M
 rosso oriente
 orient red
 rouge orient

D3012M
 rame
 copper
 cuivre

D3040M
 terra
 ground
 terre

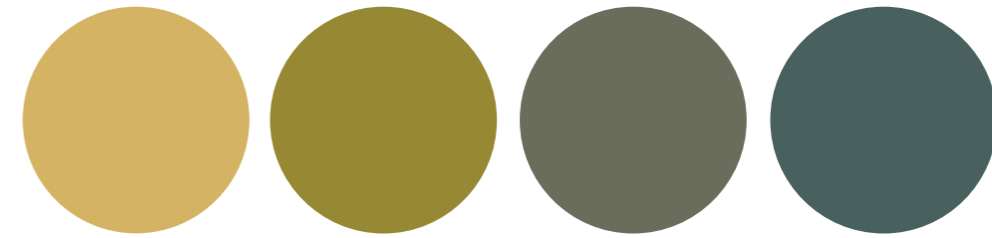

D0039M
 senape
 mustard
 moutarde

D4050M
 verde pistacchio
 pistachio green
 vert pistache

D6010M
 verde oliva
 olive green
 vert olive

D7010M
 verde bosco
 forest green
 vert forêt

TS1 - TESSUTO MIRAGE / MIRAGE FABRIC / TISSU MIRAGE



TS3 - TESSUTO FENICE / FENICE FABRIC / TISSU FENICE



TS4 - TESSUTO SNOB / SNOB FABRIC / TISSU SNOB



TS7 - TESSUTO RONDO / RONDO FABRIC / TISSU RONDO

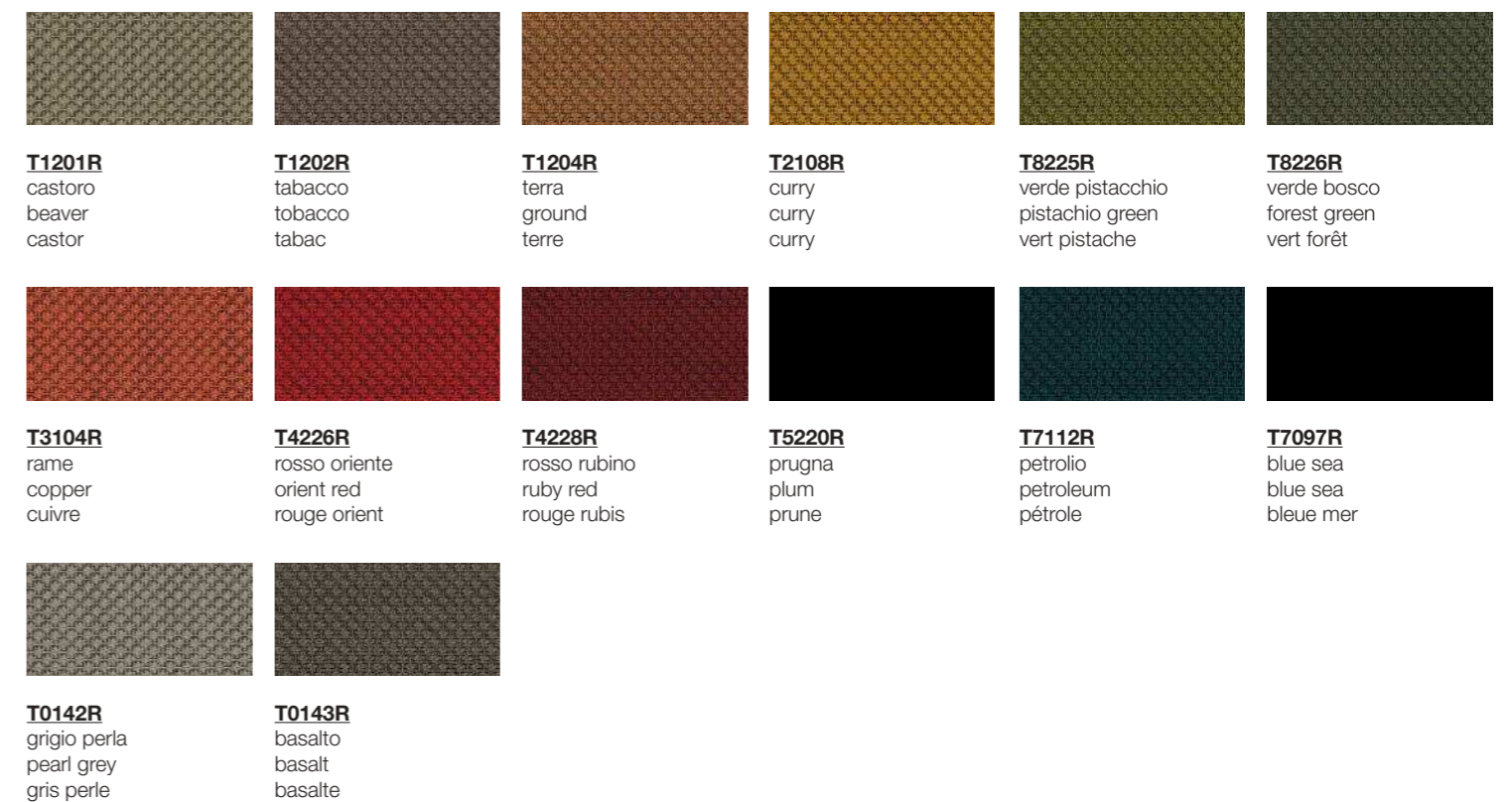

SCRIVANIA MANAGER
MANAGER DESK
BUREAU MANAGER

IT— La scrivania presenta piano e gambe in legno sp. 28 mm nelle finiture melaminico, laccato, Fenix e legno impiallacciato. Il piano è previsto anche in vetro laccato brillante e anti touch e vetro stampato effetto marmo brillante e anti touch. Il piano in vetro ha spessore 4 mm ed è supportato da un piano melaminico. La gonna ha sp. 18 mm ed è disponibile in melaminico, laccato, Fenix e legno impiallacciato. La scrivania può essere canalizzata su richiesta.

EN— The desk has wooden top and legs 28 mm th. in melamine, scratch-resistant matt lacquer, Fenix, lacquered and veneered wood finishes. The top is also available in brilliant and anti-touch lacquered glass and in printed glass with a brilliant and anti-touch marble effect. The glass top has a thickness of 4 mm and is supported by a melamine top. The modesty panel is sp. 18 mm th. and is available in melamine, Fenix, lacquered and veneered wood. The desk can be channeled on request.

F— Le bureau a un plateau et des pieds en bois ép. 28 mm en mélaminé, en laqué, en Fenix et en bois plaqué. Le plateau est également disponible en verre laqué brillant et anti-touch et en verre imprimé avec un effet marbré brillant et anti-touch. Le plateau en verre a une épaisseur de 4 mm et est soutenu par un plateau en mélamine. La voile de fond ép. 18 mm et est disponible en mélamine, en laqué, en Fenix et en bois plaqué. Le bureau peut être canalisé sur demande.

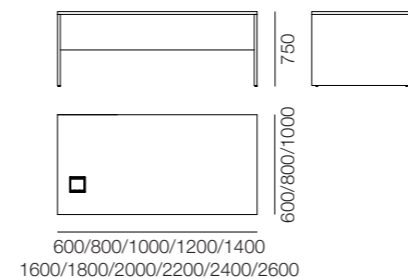

SCRIVANIA MANAGER + DATTILO
MANAGER DESK + EXTENSION
BUREAU MANAGER + RETOUR

IT— La scrivania presenta piano e gambe in legno sp. 28 mm nelle finiture melaminico, laccato, Fenix e legno impiallacciato. Il piano è previsto anche in vetro laccato brillante e anti touch e vetro stampato effetto marmo brillante e anti touch. Il piano in vetro ha spessore 4 mm ed è supportato da un piano melaminico. La gonna ha sp. 18 mm ed è disponibile in melaminico, laccato, Fenix e legno impiallacciato. La scrivania può essere canalizzata su richiesta. Il dattilo funge da comoda estensione del piano di lavoro.

EN— The desk has wooden top and legs 28 mm th. in melamine, lacquered, Fenix and veneered wood finishes. The top is also available in brilliant and anti-touch lacquered glass and in printed glass with a brilliant and anti-touch marble effect. The glass top has a thickness of 4 mm and is supported by a melamine top. The modesty panel is 18 mm th. and is available in melamine, Fenix, lacquered and veneered wood. The desk can be channeled on request. The extension acts as a convenient longer working top.

F— Le bureau a un plateau et des pieds en bois ép. 28 mm en mélaminé, laqué, en Fenix et en bois plaqué. Le plateau est également disponible en verre laqué brillant et anti-touch et en verre imprimé avec un effet marbré brillant et anti-touch. Le plateau en verre a une épaisseur de 4 mm et est soutenu par un plateau en mélamine. La voile de fond a ép. 18 mm et est disponible en mélamine, en laqué, en Fenix et en bois plaqué. Le bureau peut être canalisé sur demande. Le retour agit comme une extension pratique du bureau.

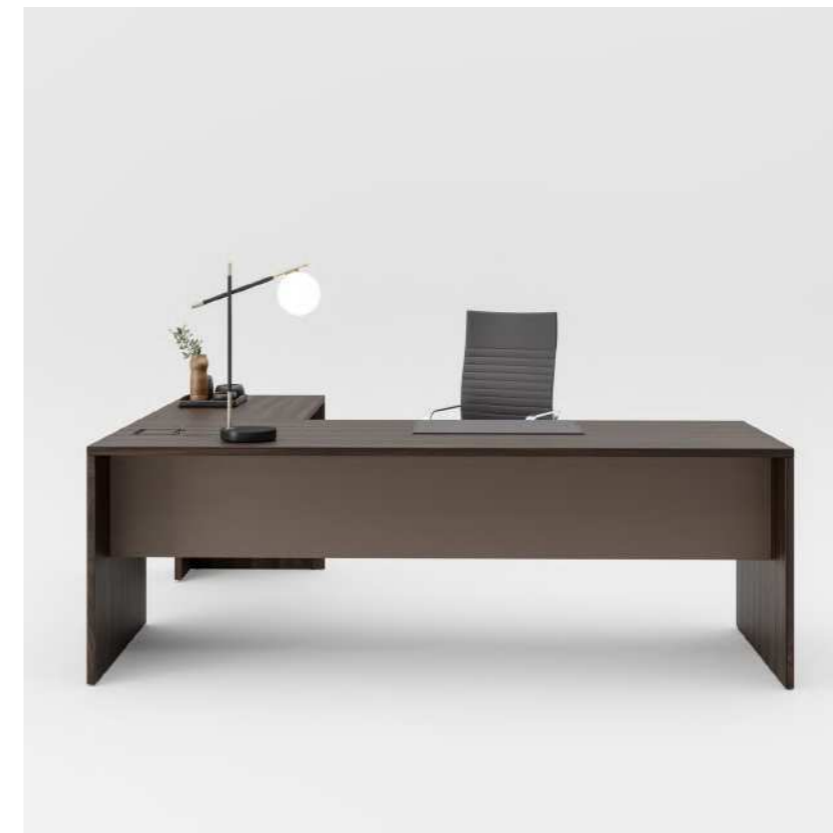
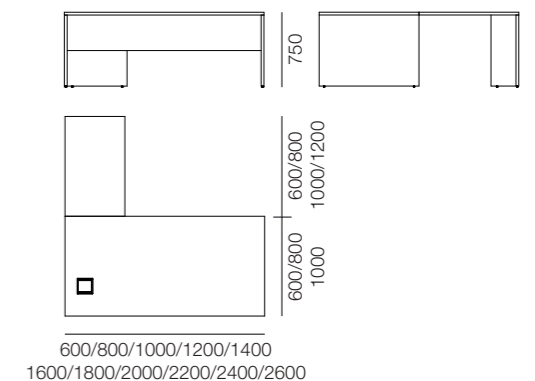



SCRIVANIA BENCH
BENCH DESK
BENCH BUREAU

IT— Configurazione con scrivanie condivise attrezzate con pannelli divisorii per garantire comfort acustico, privacy e giusta separazione.

EN— Configuration with shared desks equipped with front and side screens to guarantee acoustic comfort, privacy and right separation.

F— Le configuration avec bureaux partagés sont équipées de panneaux de séparation pour garantir le confort acoustique, l'intimité et une séparation adéquate.



SCRIVANIA + OPENWALL
BENCH DESK + OPENWALL
BENCH BUREAU + OPENWALL

IT— Le scrivanie possono essere facilmente integrate al sistema di pareti modulari Openwall, ove ci sia necessità di creare isole di lavoro o per garantire maggior privacy tra le postazioni.

EN— The desks can be easily integrated with the Openwall modular partition system, where there is a need to create work islands or to provide more privacy between workstations.

F— Les bureaux peuvent être facilement intégrés au système de cloisons modulaires Openwall, lorsqu'il est nécessaire de créer des îlots de travail ou pour assurer une plus grande intimité entre les postes de travail.





SCREEN / FRONT
SCREEN / FRONT
ÉCRAN / FRONT

IT— Pannelli divisori da scrivania per dividere le postazioni favorendo concentrazione e privacy. Semplici e lineari, da fissare alla scrivania, sono in legno melaminico o laccato nelle numerose tonalità a catalogo. Disponibili in varie lunghezze, sono alti 454 mm dal piano di lavoro, per un totale di 600 mm.

EN— Desk divider panels to separate workstations allowing concentration and privacy. Simple and linear, to be fixed to the desk, they are in melamine or lacquered wood in the numerous colours in the catalogue. Available in various lengths, they are 454 mm high from the worktop, for a total of 600 mm.

F— Panneaux de séparation des bureaux pour diviser les postes de travail en favorisant la concentration et l'intimité. Simples et linéaires, à fixer sur le bureau, ils sont en bois mélaminé ou laqué dans les nombreuses teintes du catalogue. Disponibles en plusieurs longueurs, ils se situent à 454 mm du plan de travail, soit un total de 600 mm.



SCREEN / FRONT FABRIC
SCREEN / FRONT FABRIC
ÉCRAN / FRONT FABRIC

IT— Pannelli divisori da scrivania per dividere le postazioni garantendo comfort e favorendo concentrazione e privacy. Semplici e lineari, da fissare alla scrivania, sono interamente rivestiti in tessuto disponibili in un'ampia selezione di colori, per coniugare estetica e funzionalità. Disponibili in varie lunghezze, sono alti 454 mm dal piano di lavoro, per un totale di 600 mm.

EN— Desk divider panels to divide the workstations ensuring comfort and promoting concentration and privacy. Simple and linear, to be fixed to the desk, they are fully upholstered in fabric available in a wide selection of colors, to combine aesthetics and functionality. Available in various lengths, they are 454 mm high from the worktop, for a total of 600 mm.

F— Panneaux de séparation des bureaux pour diviser les postes de travail en assurant un confort et en favorisant la concentration et l'intimité. Simples et linéaires, à fixer sur le bureau, ils sont entièrement recouverts de tissu disponibles dans un large choix de couleurs, pour allier esthétique et fonctionnalité. Disponibles en plusieurs longueurs, ils sont situés à 454 mm du plan de travail, soit un total de 600 mm.

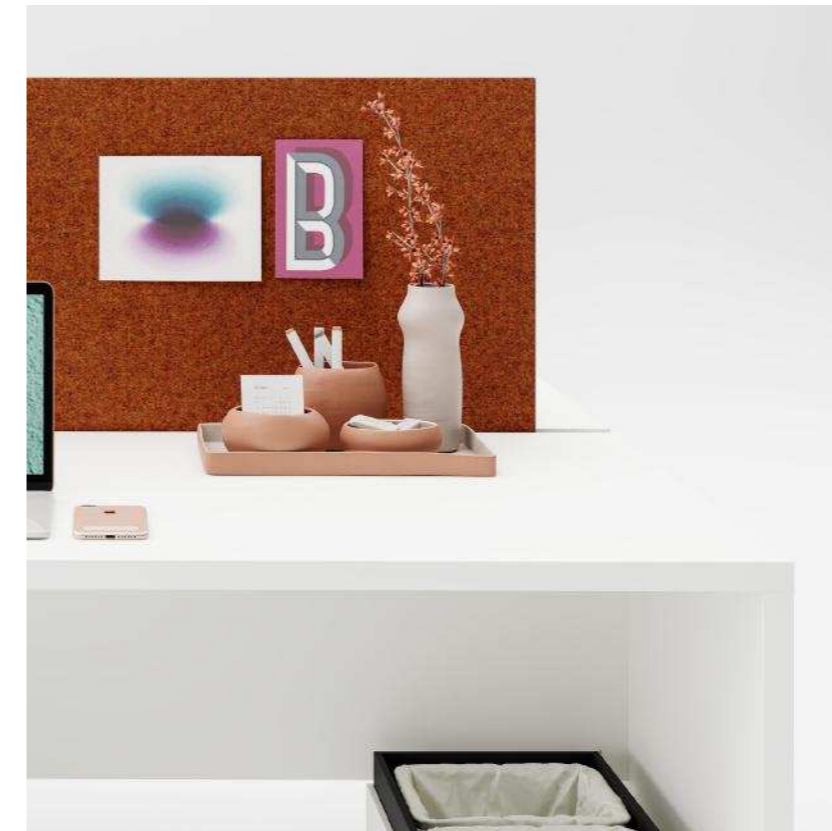

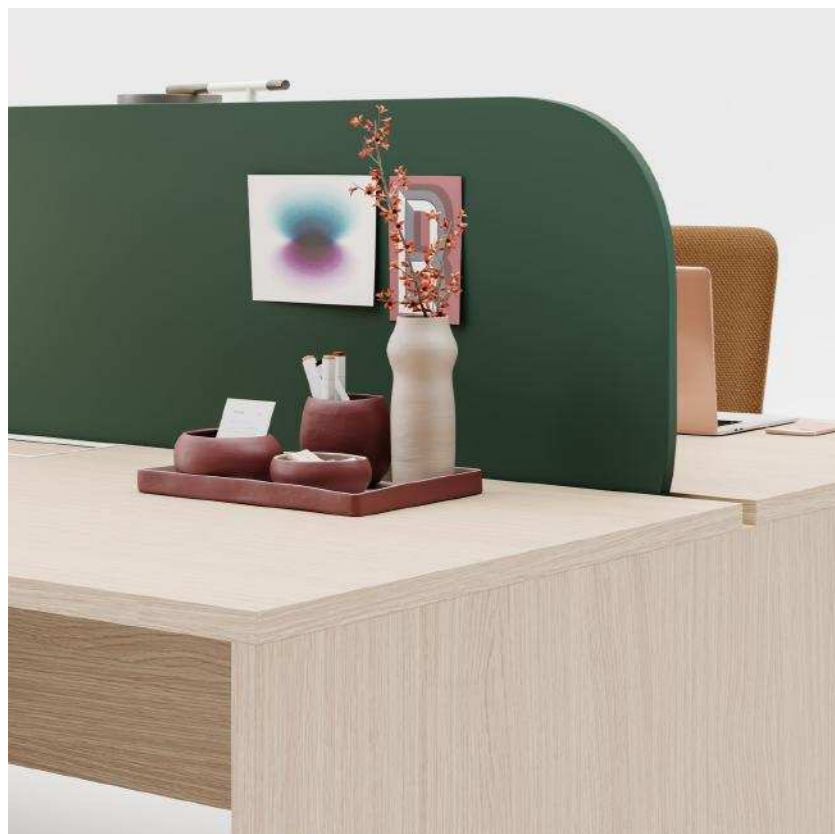

SCREEN / SOFT
SCREEN / SOFT
ÉCRAN / SOFT

IT— Pannelli divisori da scrivania per dividere le postazioni favorendo concentrazione e privacy. Semplici e arrotondati, da fissare alla scrivania, sono in legno melaminico o laccato nelle numerose tonalità a catalogo. Disponibili in varie lunghezze, sono alti 454 mm dal piano di lavoro, per un totale di 600 mm.

EN— Desk divider panels to separate workstations allowing concentration and privacy. Simple and rounded, to be fixed to the desk, they are in melamine or lacquered wood in the numerous colours in the catalogue. Available in various lengths, they are 454 mm high from the worktop, for a total of 600 mm.

F— Panneaux de séparation des bureaux pour diviser les postes de travail en favorisant la concentration et l'intimité. Simples et arrondis, ils sont en bois mélaminé ou laqué dans les nombreuses teintes du catalogue. Disponibles en plusieurs longueurs, ils se situent à 454 mm du plan de travail, soit un total de 600 mm.

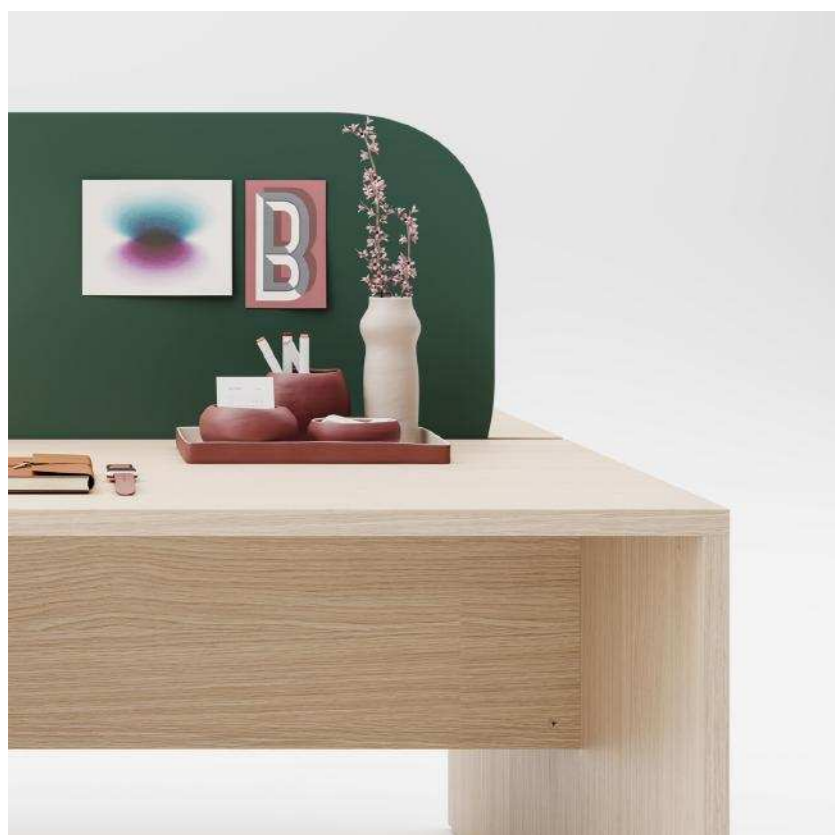

SCREEN / ACOUSTIC SOFT FABRIC
SCREEN / ACOUSTIC SOFT FABRIC
ÉCRAN / ACOUSTIC SOFT FABRIC

IT— Pannelli divisori da scrivania per dividere le postazioni garantendo comfort acustico e favorendo concentrazione e privacy. Dalla forma arrotondata e fissati alla scrivania, sono interamente rivestiti in tessuto con materiale fonoassorbente all'interno, disponibili in un'ampia selezione di colori, per coniugare estetica e funzionalità. Disponibili in varie lunghezze, sono alti 454 mm dal piano di lavoro, per un totale di 600 mm.

EN— Desk divider panels to divide the workstations ensuring acoustic comfort and promoting concentration and privacy. With their rounded shape and fixed to the top, they are fully upholstered in fabric with inner sound-absorbing material in a wide selection of colors, to combine aesthetics and functionality. Available in various lengths, they are 454 mm high from the worktop, for a total of 600 mm.

F— Panneaux de séparation des bureaux pour diviser les postes de travail en assurant un confort acoustique et en favorisant la concentration et l'intimité. De forme arrondie et fixés au bureau, ils sont entièrement recouverts de tissu avec un matériau insonorisant à l'intérieur dans un large choix de couleurs, pour allier esthétique et fonctionnalité. Disponibles en plusieurs longueurs, ils sont situés à 454 mm du plan de travail, soit un total de 600 mm.

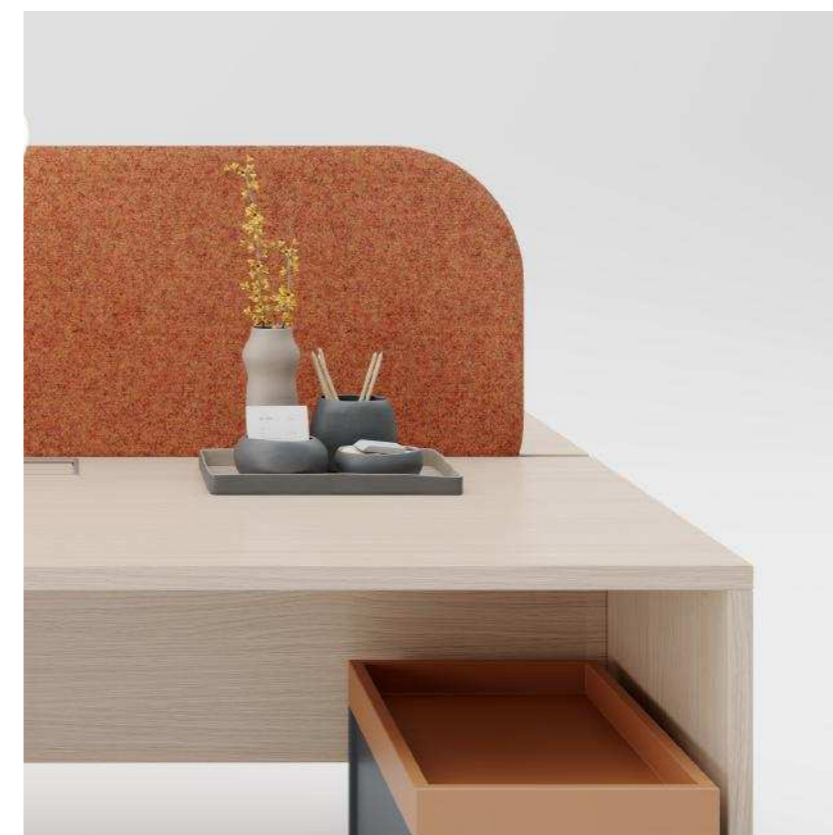



SCREEN / ACOUSTIC SOFT TRAY
 SCREEN / ACOUSTIC SOFT TRAY
 ÉCRAN / ACOUSTIC SOFT TRAY

IT— Pannelli divisori da scrivania freestanding, da posizionare liberamente sul piano di lavoro quando serve concentrazione, privacy e comfort acustico.

Dalla forma arrotondata, sono interamente rivestiti in tessuto con materiale fonoassorbente all'interno, disponibili in un'ampia selezione di colori, per coniugare estetica e funzionalità. Sono dotati di una base metallica che funge da comodo vassoio porta oggetti, verniciato in tinta o a contrasto nelle varie tonalità a catalogo. Disponibili in varie lunghezze, sono alti 454 mm dal piano di lavoro.

EN— Freestanding desk divider panels to be placed freely on the worktop, when you need concentration, privacy and acoustic comfort. With their rounded shape, they are fully upholstered in fabric with inner sound-absorbing material in a wide selection of colors, to combine aesthetics and functionality. They are equipped with a metal base that acts as a convenient tray for objects, painted in the same color or in contrast in the various shades. Available in various lengths, they are 454 mm high from the worktop.

F— Panneaux de séparation de bureau autoportante à placer librement sur le plan de travail lorsque la concentration, le confort acoustique et l'intimité sont nécessaires. De forme arrondie, ils sont entièrement recouverts de tissu avec un matériau insonorisant à l'intérieur dans un large choix de couleurs, pour allier esthétique et fonctionnalité. Il est équipé d'une base en métal qui agit comme un plateau pratique pour les objets, peints de la même couleur ou en contraste dans les différentes nuances. Disponibles en plusieurs longueurs, ils sont situés à 454 mm du plan de travail.





CASSETTO SMART
SMART DRAWER
TIROIR SMART

IT— La scrivania può essere attrezzata con un cassetto sottopiano metallico con serratura, disponibile nei vari colori a catalogo.

EN— The desk can be equipped with a metal undertop drawer with lock, available in the various colours in the catalogue.

F— Le bureau peut être équipé d'un tiroir inférieur en métal avec serrure, disponible dans les différentes couleurs du catalogue.



PORTA CPU
CPU HOLDER
PORTE CPU

IT— La scrivania può essere attrezzata con un porta CPU metallico sospeso fissato alla gamba destra o sinistra, oppure su ruote.

EN— The desk can be equipped with a suspended metal CPU holder fixed to the right or left leg, or on castors.

F— Le bureau peut être équipé d'un support métallique suspendu pour ordinateur, fixé au pied droite ou gauche, or sur roulettes.





CASSETTIERA SU RUOTE
PEDESTAL DRAWERS UNIT ON CASTORS
CAISSON TIROIRS SUR ROULETTES

IT— Cassettiera in legno su ruote con tre cassetti e serratura. È disponibile in melaminico, laccato, Fenix e impiallacciato.

EN— Wooden pedestal three drawers unit on castors with lock. It is available in melamine, lacquered, Fenix and wood veneer.

F— Caisson tiroirs sur roulettes en bois avec trois tiroirs et serrure. Il est disponible en mélamine, en laqué, en Fenix et en plaqué bois.

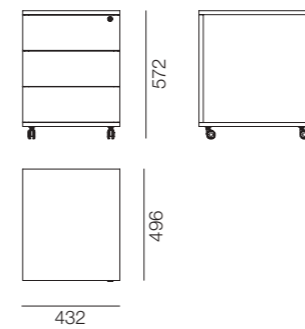



CASSETTIERA SU RUOTE
PEDESTAL DRAWERS UNIT ON CASTORS
CAISSON TIROIRS SUR ROULETTES

IT— Cassettiera in legno su ruote con due cassetti, serratura e vassoio porta oggetti. È disponibile in melaminico, laccato, Fenix e impiallacciato.

EN— Wooden pedestal two drawers unit on castors with lock and glove compartment. It is available in melamine, lacquered, Fenix and wood veneer.

F— Caisson tiroirs sur roulettes en bois avec deux tiroirs, serrure et plateau pour objets. Il est disponible en mélamine, en laqué, en Fenix et en plaqué bois.

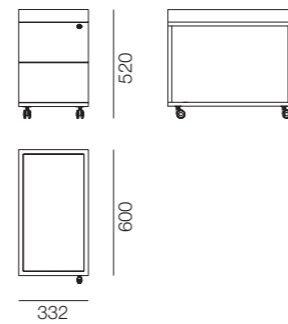



MOBILE DI SERVIZIO
SERVICE UNIT
MEUBLE DE SERVICE

IT— STORE è un mobile di servizio disponibile su ruote o fisso con vassoio superiore, anta e due cassetti push to open. È disponibile in legno melaminico, laccato opaco antigraffio, Fenix e impiallacciato.

EN— STORE is a service unit available on castors or fixed with upper glove compartment, push to open door and two drawers. It is available in melamine wood, scratch-resistant matt lacquered, Fenix and wood veneer.

F— STORE est un meuble de service disponible sur roulettes ou fixe avec plateau supérieur pour objets, porte et deux tiroirs push to open. Il est disponible en bois mélaminé, en laqué mat résistant aux rayures, en Fenix et en plaqué bois.

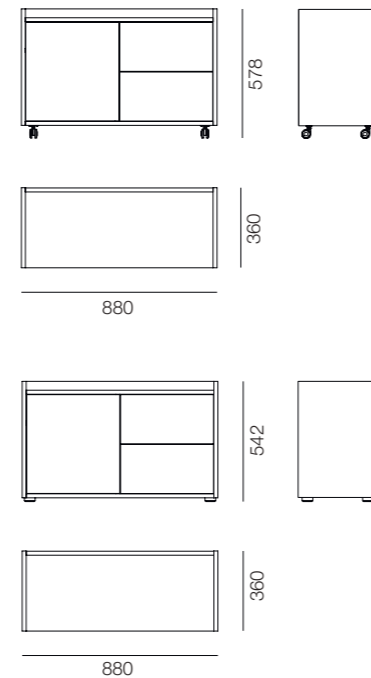

TAVOLO RIUNIONE
MEETING TABLE
TABLE DE RÉUNION

IT— Il tavolo riunione rettangolare è previsto in varie profondità e lunghezze ed è interamente in legno. Il piano e le gambe sono in legno sp. 28 mm disponibili nelle finiture melaminico, laccato, Fenix e legno impiallacciato. Il piano è previsto anche in vetro laccato brillante e anti touch e vetro stampato effetto marmo brillante e anti touch. Il piano in vetro ha spessore 4 mm ed è supportato da un piano melaminico. La gonna ha sp. 18 mm ed è disponibile in melaminico, laccato, Fenix e legno impiallacciato. Il tavolo può essere canalizzato su richiesta.

EN— The rectangular meeting table is available in various depths and lengths and is entirely made of wood. The top and legs are in wood 28 mm th. available in melamine, lacquered, Fenix and veneered wood finishes. The top is also available in brilliant and anti-touch lacquered glass and in printed glass with a brilliant and anti-touch marble effect. The glass top has a thickness of 4 mm and is supported by a melamine top. The modesty panel is 18 mm th. and is available in melamine, Fenix, lacquered and veneered wood. The table can be channeled on request.

F— La table de réunion rectangulaire est disponible en différentes profondeurs et longueurs et est entièrement réalisée en bois. Le plateau et les pieds sont en bois ép. 28 mm disponible en mélamine, en laqué, en Fenix et en bois plaqué. Le plateau est également disponible en verre laqué brillant et anti-touch et en verre imprimé avec un effet marbré brillant et anti-touch. Le plateau en verre a une épaisseur de 4 mm et est soutenu par un plateau en mélamine. La voile de fond est ép. 18 mm et est disponible en mélamine, en laqué, en Fenix et en bois plaqué. La table peut être canalisée sur demande.

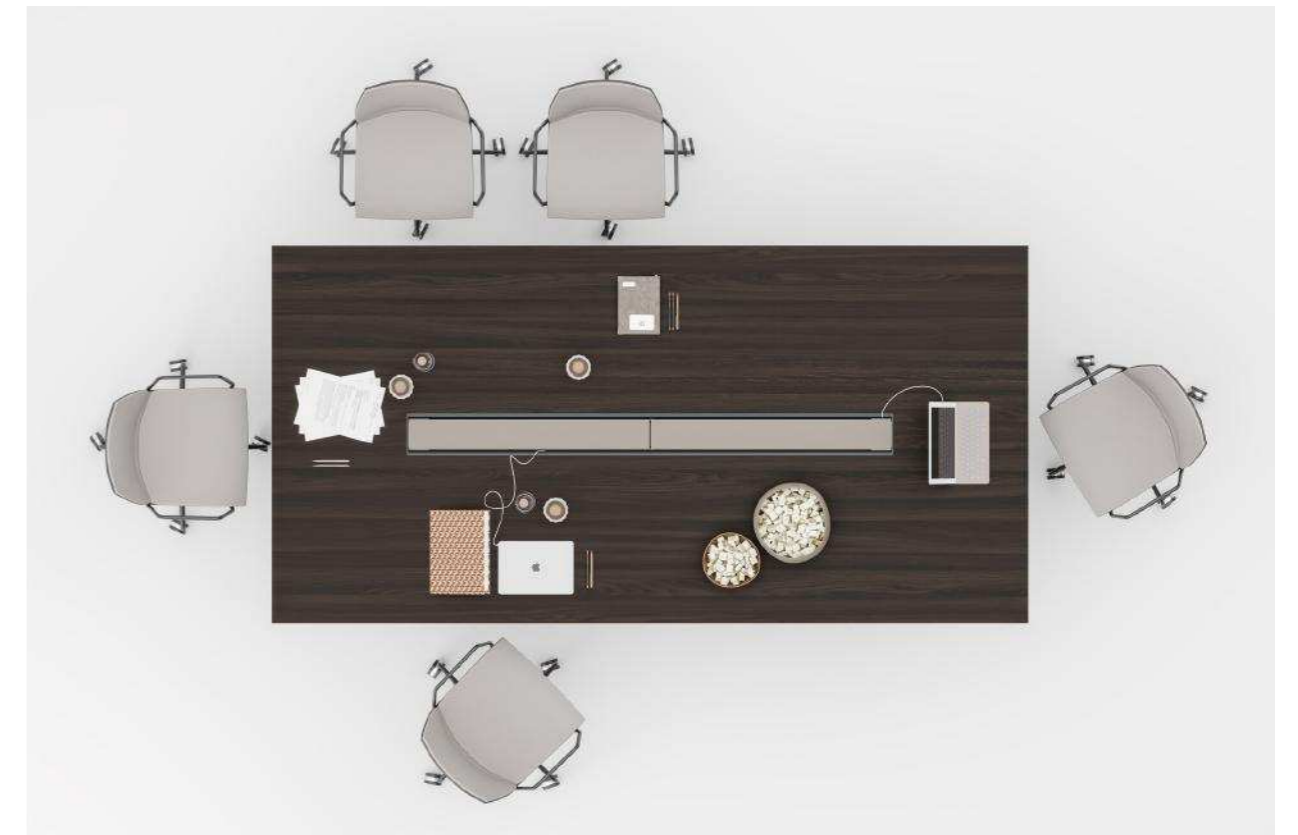
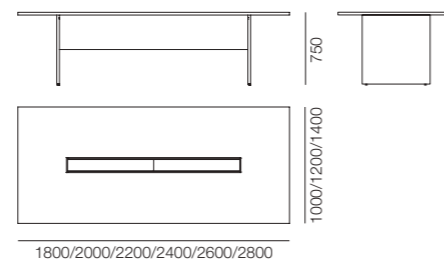

TAVOLO RIUNIONE MODULARE
MODULAR MEETING TABLE
TABLE DE RÉUNION MODULAIRE

IT— Il tavolo riunione rettangolare è previsto in varie profondità e lunghezze con piani componibili ed è interamente in legno. Il piano e le gambe sono in legno sp. 28 mm disponibili nelle finiture melaminico, laccato, Fenix e legno impiallacciato. Il piano è previsto anche in vetro laccato brillante e anti touch e vetro stampato effetto marmo brillante e anti touch. Il piano in vetro ha spessore 4 mm ed è supportato da un piano melaminico. La gamba ha sp. 18 mm ed è disponibile in melaminico, laccato, Fenix e legno impiallacciato. Il tavolo può essere canalizzato su richiesta.

EN— The rectangular meeting table is available in various depths and lengths with modular tops and is entirely made of wood. The top and legs are in wood 28 mm th. available in melamine, lacquered, Fenix and veneered wood finishes. The top is also available in brilliant and anti-touch lacquered glass and in printed glass with a brilliant and anti-touch marble effect. The glass top has a thickness of 4 mm and is supported by a melamine top. The modesty panel is 18 mm th. and is available in melamine, Fenix, lacquered and veneered wood. The table can be channelled on request.

F— La table de réunion rectangulaire est disponible en différentes profondeurs et longueurs avec des plateaux modulables et est entièrement réalisée en bois. Le plateau et les pieds sont en bois ép. 28 mm disponible en mélamine, en laqué, en Fenix et en bois plaqué. Le plateau est également disponible en verre laqué brillant et anti-touch et en verre imprimé avec un effet marbré brillant et anti-touch. Le plateau en verre a une épaisseur de 4 mm et est soutenu par un plateau en mélamine. La jupe a ép. 18 mm et est disponible en mélamine, en laqué, en Fenix et en bois plaqué. La table peut être canalisée sur demande.

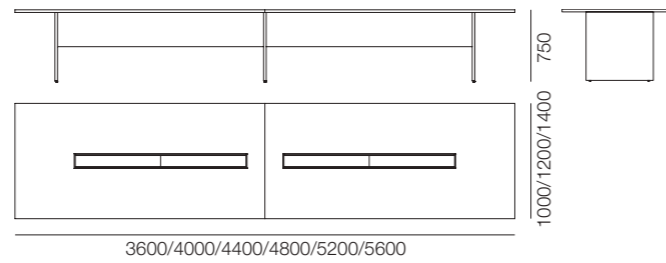

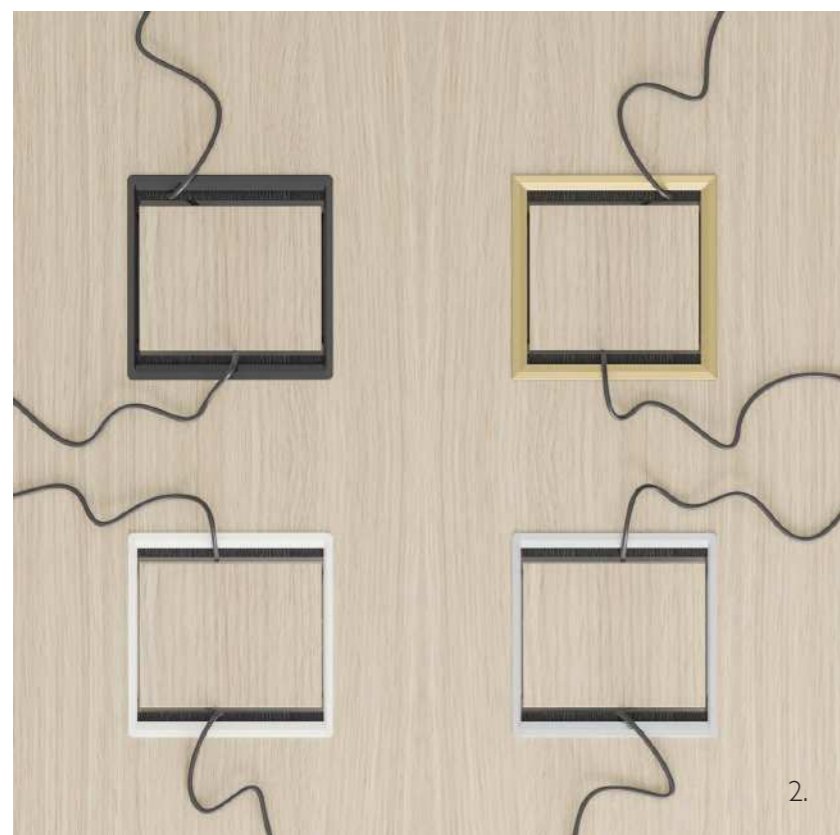
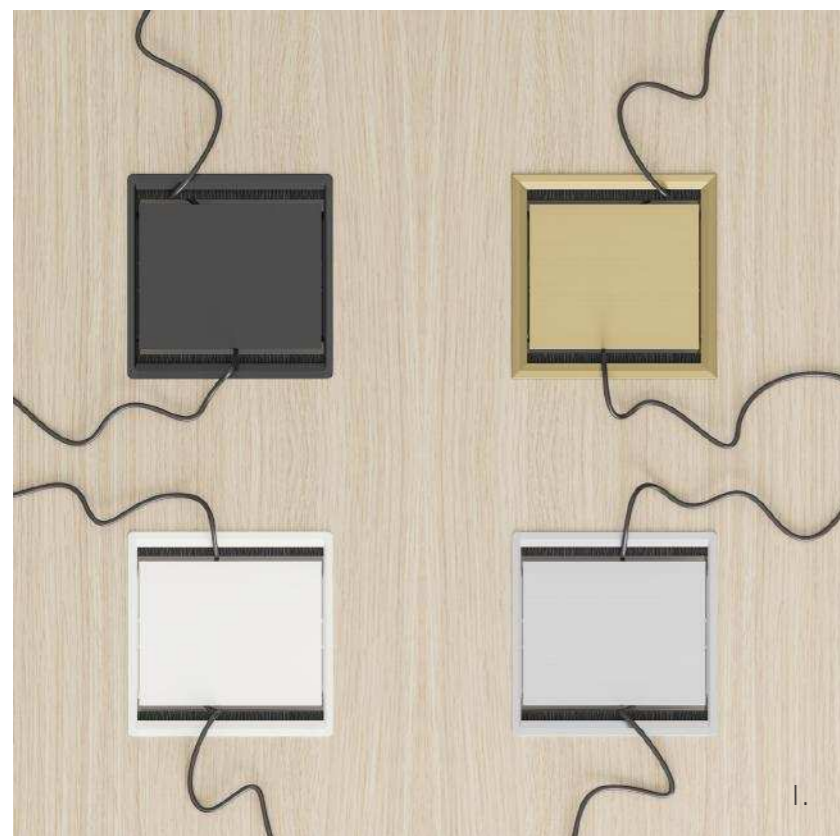

CANALIZZAZIONE / PASSACAVI
WIRING / CABLE TIDIES
CABLAGE / PASSE-CABLES

IT— 1. Il passacavo metallico Profcable è composto da profili e sportello in finitura anodizzata alluminio, nero, ottone e verniciato bianco. È realizzato con un sistema di doppia apertura basculante e rapido sistema di rimozione del coperchio, che permette un accesso veloce al cablaggio sottostante. È previsto in formato quadrato 150x150 mm e rettangolare largo 150 mm e in varie lunghezze.
2. Su richiesta è disponibile un pannello di finitura applicato sul coperchio per garantire continuità di finitura tra piano e passacavo ed una vaschetta di canalizzazione per multipresa.

3. In alternativa si può scegliere un passacavo rotondo in plastica ø 60 mm nei colori bianco, nero e grigio.
4. Oppure metallico ø 60 e 80 mm nei colori bianco, nero e inox.

EN— 1. The Profcable metal cable tidy is composed of profiles and tilting panel in anodized aluminium, black, brass finish and white lacquered finish. It is made with a double tilting opening system and a quick access to the underlying wiring. It is available in square 150x150 mm and rectangular 150 mm wide and in various lengths.

2. Optional there is a finishing panel applied on the tilting cover to ensure the continuity of the finish between the top and the cable tidy and a cabling tray for multi-sockets.

3. Alternatively, it is possible to choose a round plastic cable tidy ø 60 mm in white, black and grey colors.
4. Or a metallic cable tidy ø 60 and 80 mm in white, black and inox colors.

F— 1. Le passe-cable métallique Profcable se compose de profils et d'une porte en aluminium anodisé, en noir, en laiton et en peinture blanche. Il est réalisé avec un système d'ouverture à double battant et un système de retrait rapide du couvercle, qui permet un accès rapide au câblage situé en dessous. Il est disponible en format carré de 150x150 mm et rectangulaire de 150 mm de large et en différentes longueurs.
2. Sur demande, un panneau de finition appliqué sur le couvercle est disponible pour garantir la continuité de la finition entre le dessus et le presse-étoupe et un plateau de canalisation pour les prises multiples.

3. En alternative, il est possible de choisir un passe-cable rond en plastique ø 60 mm en blanc, noir et gris.
4. Ou un passe-cable métallique ø 60 et 80 mm en couleur blanc, noir et inox.

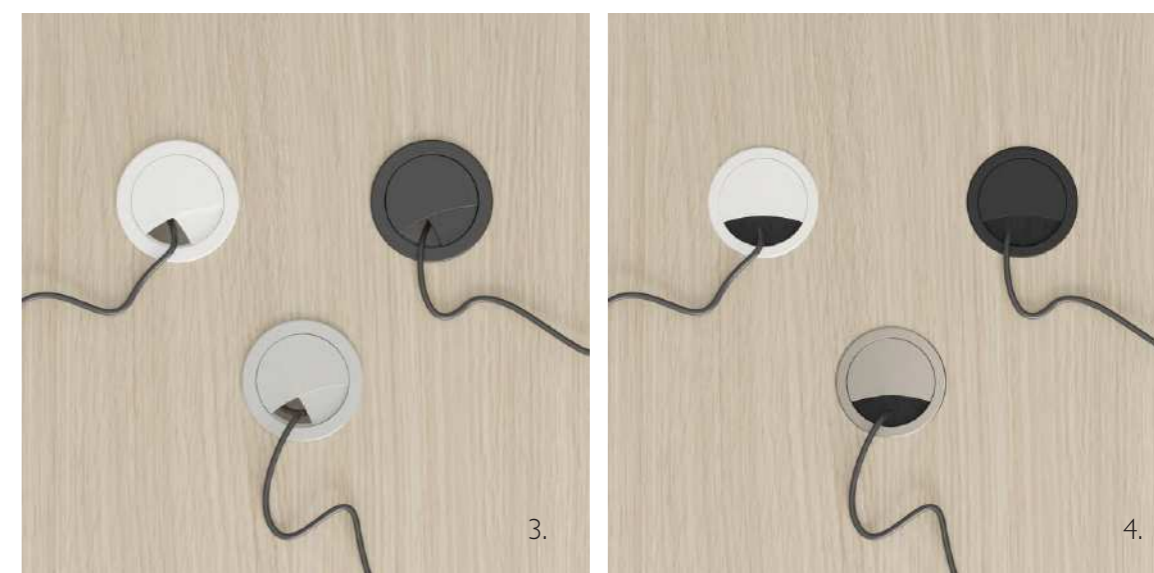
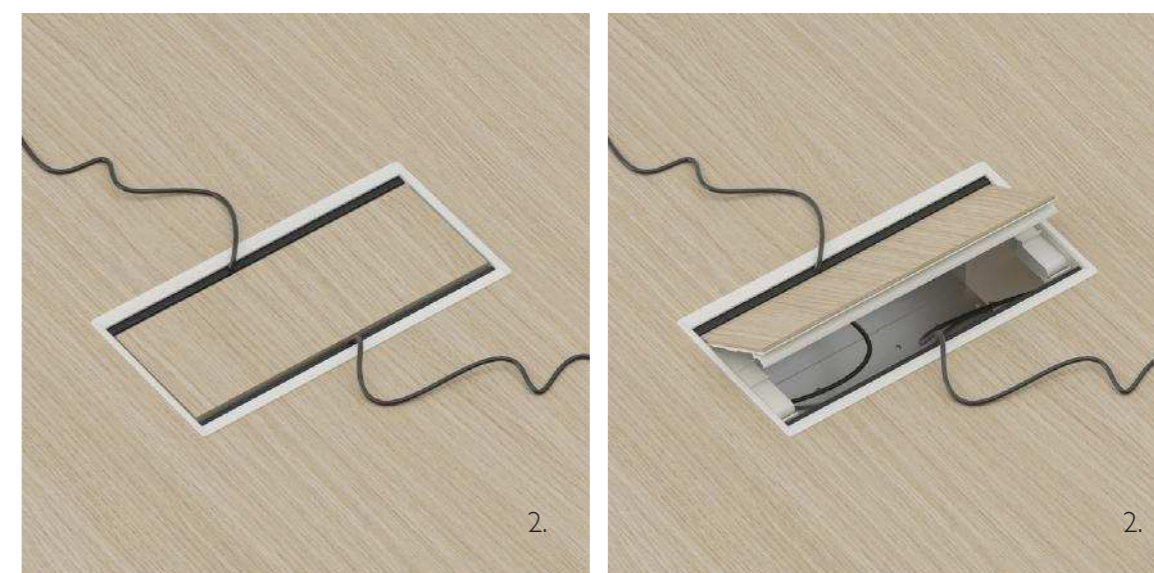
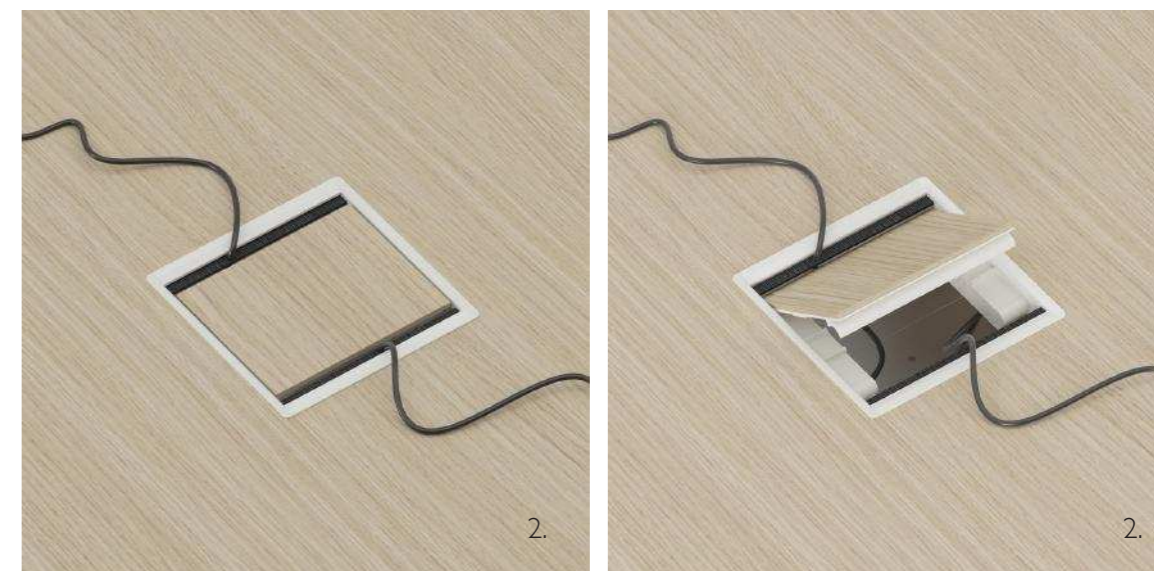



1.



2.

CANALIZZAZIONE / GESTIONE DEI CAVI
WIRING / CABLE MANAGEMENT
CABLAGE / GESTION DES CABLES

IT— Scrivania singola: per la risalita verticale dei cavi da terra sono disponibili una vertebra (1.) o in alternativa dei cable grip (2.). Per la fuoriuscita sul piano è disponibile il Proficable metallico quadrato o rettangolare con vaschetta per multipresa.

Scrivania bench: per la risalita verticale dei cavi da terra sono disponibili una vertebra (3.) o dei cable grip (4.). I cavi sotto piano vengono raccolti da cable grip e da una vaschetta multipresa da integrare al Proficable rettangolare per la fuoriuscita dei cavi sul piano.

EN— Single desk: a vertebra (1.) or cable grips (2.) are available for vertical cable routing from the floor. The square or rectangular metal Proficable is available for the cable outlet on the top, with a tray for a multisolet.

Desk bench: for vertical cable routing from the floor, a cable vertebra (3.) or cable grips (4.) are available. Cables under the desk top are collected by fixed cable grips and the multi-socket tray which is integrated into the rectangular Proficable for cable outlets on the desk top.

F— Bureau simple: pour le passage vertical des câbles depuis le sol, une vertèbre de câble (1.) ou des poignées de câble (2.) sont disponibles. Le Proficable carré ou rectangulaire en métal avec plateau multi-sorties est disponible pour la sortie de câble sur le dessus.

Bureau bench: une vertèbre de câble (3.) ou des poignées de câble (4.) sont disponibles pour le passage vertical des câbles depuis le sol. Les câbles sous le plan de travail sont collectés par des serre-câbles fixes et par le chemin de câbles qui est intégré dans le Proficable rectangulaire pour la sortie de câbles sur le plan de travail.



3.



4.



ACCESSORI / BOX
ACCESSORIES / BOX
ACCESOIRES / BOÎTE

IT— BOX in legno porta piante o porta oggetti in altezza 150 mm con due profondità e due larghezze. Da posizionare sopra i mobili Profbox, Profslide e Modular unit per conferire un tocco di green all'ambiente, è disponibile in finitura melaminico o laccato nelle numerose tonalità a catalogo.

EN— Wooden BOX for plants or objects in 150 mm height with two depths and two widths. To be placed on top of Profbox, Profslide and Modular unit furniture to give a touch of green to the environment, it is available in a melamine or lacquered finish in the numerous colours in the catalogue.

F— BOÎTE pour plantes ou objets en bois de 150 mm de hauteur avec deux profondeurs et deux largeurs. À placer sur les meubles Profbox, Profslide et Modular unit pour donner une touche de vert à l'environnement, il est disponible en finition mélaminée ou laquée dans les nombreuses couleurs du catalogue.



COMPLEMENTI / GETTACARTE E FIORIERA
COMPLÉMENTS / WASTEPAPER AND PLANTER
COMPLÉMENTS / CORBEILLE POUR PAPIERS ET PLANTER

IT— SQUARE è un gettacarte in legno melaminico disponibile nella versione singola o doppia, entrambe fornite di serie con ferma sacchetto superiore.

SESSANTA è un complemento in legno melaminico da utilizzare come porta riviste o porta piante ad uso interno, da dotare di porta vaso. Fa parte di una collezione più ampia di tavoli caffè, disponibili quadrati e rettangolari in varie dimensioni e finiture.

EN— SQUARE is a melamine wooden wastepaper available in the single version or double, both of which come standard with top bag stopper.

SESSANTA is a melamine wooden complement to use as a magazine or indoor plant holder, to be equipped with a vase holder. It is part of a wider collection of coffee tables, available square and rectangular in various sizes and finishes.

F— SQUARE est un enveloppe en bois disponible en version unique ou double, les deux étant livrés en standard avec un bouchon de sac supérieur.

SESSANTA est un complément en bois à utiliser comme magasin ou planter intérieurs, à équiper d'un porte-vase. Il fait partie d'une collection plus large de tables basses, carrées et rectangulaires, disponibles en différentes tailles et finitions.





TAVOLI CAFFÈ
COFFEE TABLES
TABLES BASSES

IT— Collezione di tavolini quadrati e rettangolari disponibili in cinque misure, da utilizzare singolarmente o da abbinare tra loro. Presentano piano e gambe in legno sp. 28 mm nelle finiture melaminico, laccato, Fenix e legno impiallacciato. Il piano è previsto anche in vetro laccato brillante e anti touch e vetro stampato effetto marmo brillante e anti touch. Il piano in vetro ha spessore 4 mm ed è supportato da un piano melaminico. La gonna ha sp. 18 mm ed è disponibile in melaminico, laccato, Fenix e legno impiallacciato.

EN— Collection of square and rectangular coffee tables available in five sizes, to be used individually or combined with each other. They have wooden top and legs 28 mm th. in melamine, lacquered, Fenix and veneered wood finishes. The top is also available in brilliant and anti-touch lacquered glass and in printed glass with a brilliant and anti-touch marble effect. The glass top has a thickness of 4 mm and is supported by a melamine top. The modesty panel is sp. 18 mm th. and is available in melamine, Fenix, lacquered and veneered wood.

F— Collection de tables basses carrées et rectangulaires disponibles en cinq tailles, à utiliser individuellement ou à combiner entre elles. Ils ont un plateau et des pieds en bois ép. 28 mm en mélaminé, en laqué, en Fenix et en bois plaqué. Le plateau est également disponible en verre laqué brillant et anti-touch et en verre imprimé avec un effet marbré brillant et anti-touch. Le plateau en verre a une épaisseur de 4 mm et est soutenu par un plateau en mélamine. La voile de fond ép. 18 mm et est disponible en mélamine, en laqué, en Fenix et en bois plaqué.

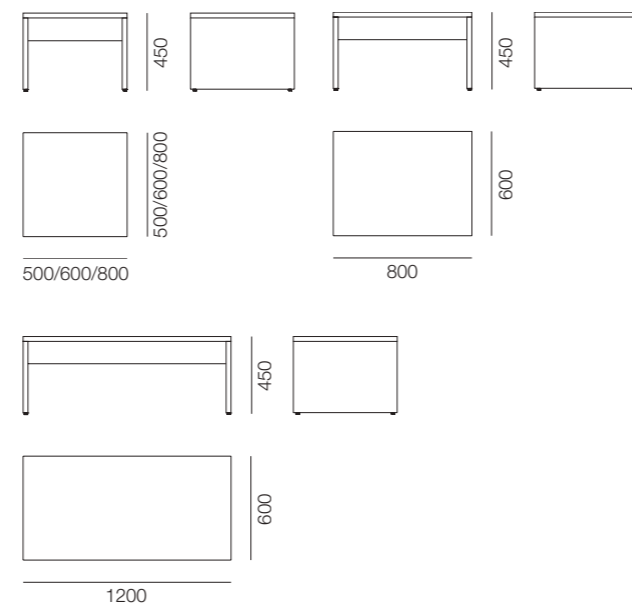

COMPLEMENTI / GETTACARTE E FIORIERA
COMPLEMENTS / WASTEPAPER AND PLANTER
COMPLÉMENTS / CORBEILLE ET PLANTER

IT— LOUISE è una collezione di fioriere da interno, portaombrelli e gettacarte. Complementi eleganti e sofisticati, divengono veri e propri elementi di arredo per interni, perfetti per ambienti lavorativi e domestici. La struttura è in metallo verniciata nelle numerose tonalità previste a catalogo. Il rivestimento è in vetro effetto marmo o tinta unita, effetto brillante o antitouch, da giocare tono su tono o in contrasto cromatico. Per facilitare il movimento, sono dotati di ruote a scomparsa totale.

Il GETTACARTE è disponibile in due misure, con funzione di cestino singolo o doppio.

La FIORIERA è quadrata e rettangolare in tre varianti dimensionali, da utilizzare singolarmente o riunite in composizioni.

EN— LOUISE is a collection of indoor planters, wastepaper and umbrella stand. Refined and sophisticated, they become genuine interior design accessories, perfect for both work and home environments. The structure is in matt varnished metal in several finishes included in the catalog. The covering is in printed glass or single color, with brilliant or anti touch effect to play tone on tone or in color contrast. To facilitate movement they are equipped with recessed wheels.

The WASTEPAPER is available in two sizes as single or double. The PLANTER is square and rectangular, available in three different sizes to use singly or in compositions.

F— LOUISE est une collection de planters intérieurs, corbeille à papier et porte-parapluies. Précieux et raffinés, ces bacs à fleurs s'insèrent parfaitement dans la décoration d'intérieur, idéaux dans des espaces de travail et chez soi. La structure est en métal, peinte dans les nombreuses couleurs disponibles dans le catalogue. Les revêtements sont en verre imprimé effet marbre ou en couleur unie, brillants ou anti empreintes, à jouer ton sur ton ou en couleurs contrastantes. Pour faciliter les déplacements, ils sont équipés de roulettes entièrement escamotables.

Le CORBEILLE À PAPIER est disponible en deux tailles avec fonction simple ou double. Le BAC À FLEURS est carré et rectangulaire en trois tailles différentes à utiliser seuls ou assortis les uns aux autres.

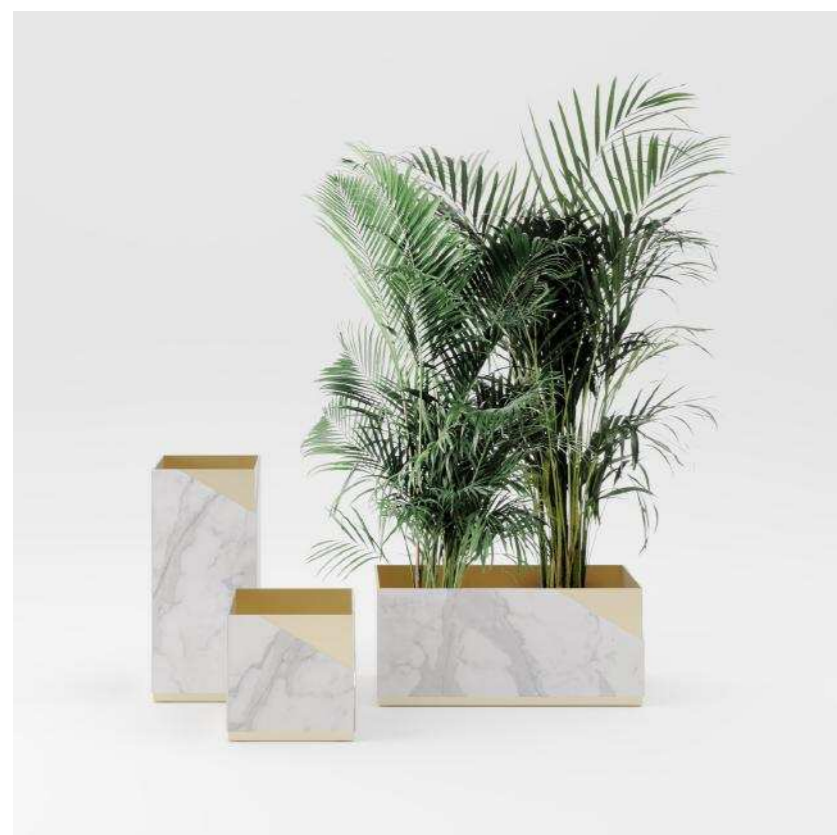
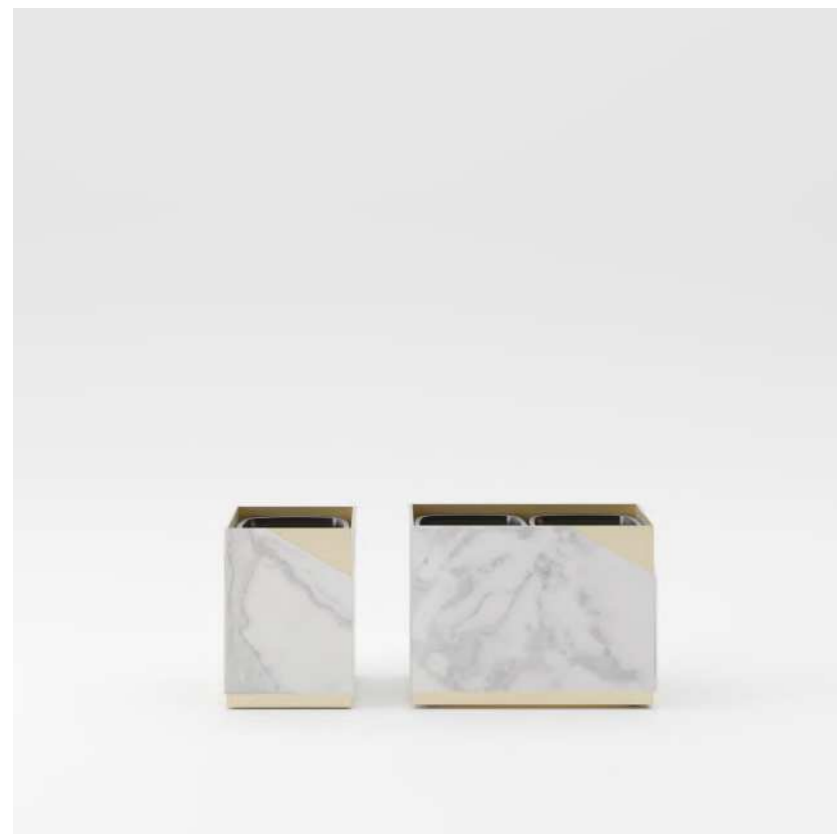

COMPLEMENTI / APPENDIABITI E TAVOLI
COMPLEMENTS / COAT STANDS AND TABLES
COMPLÉMENTS / CINTRES A VETEMENTS ET TABLES



IT— L'appendiabiti JANE ha una struttura metallica verniciata opaca con base circolare, stelo e tre bracci disponibili nell'ampia gamma di tonalità a catalogo. I bracci montano sei sfere con particolari che possono essere in ottone spazzolato, nichel spazzolato, nichel nero spazzolato. Per un aspetto ancora più prezioso, la base circolare è prevista anche in marmo. Essenziale e decorativo, si inserisce perfettamente in ambienti di stili e contesti diversi con massima libertà di personalizzazione.

La collezione TABLE è una famiglia di tavoli riunione, tavoli caffè, tavoli alti e tavoli lounge. Di forma rotonda, quadrata, rettangolare e ovale, sono disponibili in varie misure e altezze. La struttura del tavolo è in tubolare metallico con piastre superiori e inferiori verniciate opache nelle finiture a catalogo. Il piano è disponibile con bordo a saponetta o con bordo dritto in tutte le finiture disponibili a catalogo.

EN— JANE coat stand has a matt varnished metal structure with circular base, stem and three arms available in the wide range of colours in the catalogue. The arms assemble six spheres with details that can be in brushed brass, brushed nickel, brushed black nickel. For a more precious appearance, the circular base is also available in marble. Essential and decorative, it fits perfectly in environments of different styles and contexts with maximum freedom of customization.

The TABLE collection is a family of meeting tables, coffee tables, high tables and lounge tables. Round, square, rectangular and oval in shape, they are available in various sizes and heights. The structure of the table is in metal tubular with upper and lower plates matt painted in the catalogue finishes. The top is available with a waterfall edge or with a straight edge in all the finishes available in the catalogue.

F— Le porte-manteau JANE a une structure en métal verni mat avec une base circulaire, une tige et trois bras disponibles dans la large gamme de teintes du catalogue. Les bras portent six sphères avec des détails qui peuvent être en laiton brossé, en nickel brossé, en nickel noir brossé. Pour un aspect encore plus précieux, la base circulaire est également disponible en marbre. Essentiel et décoratif, il s'intègre parfaitement dans des environnements de styles et de contextes différents avec une liberté de personnalisation maximale.

La collection TABLE est une famille de tables de réunion, tables basses, tables hautes et tables basses. De forme ronde, carrée, rectangulaire et ovale, ils sont disponibles en différentes tailles et hauteurs. La structure de la table est en tube métallique avec des plaques supérieure et inférieure peintes mates dans les finitions du catalogue. Le plateau est disponible avec un bord façonné ou avec un bord droit dans toutes les finitions disponibles dans le catalogue.

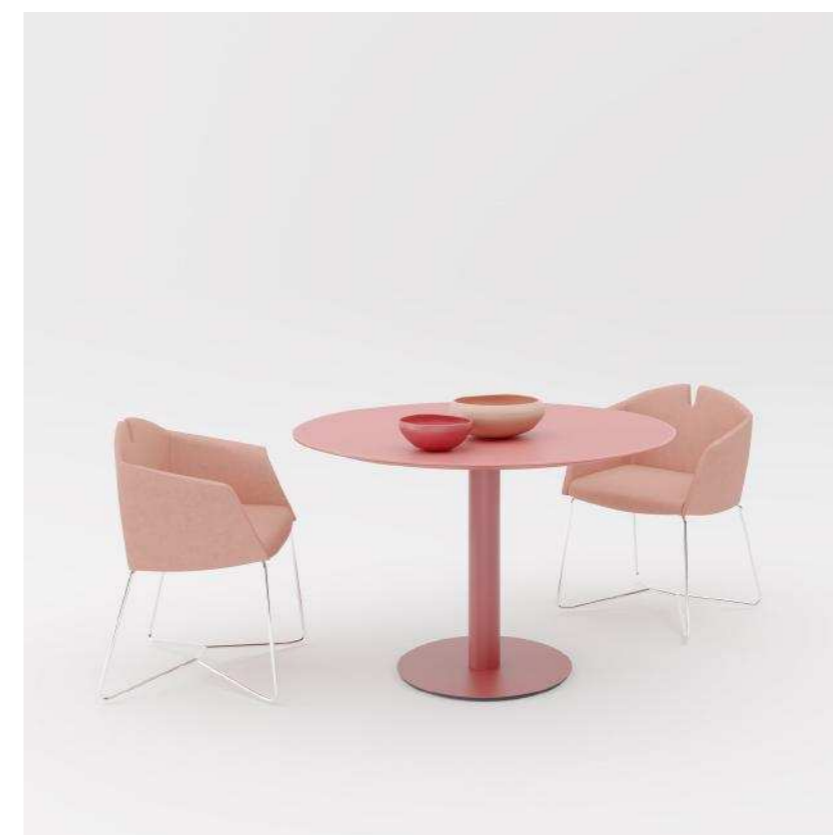

COMPLEMENTI / SOTTOMANO E SET SCRIVANIA
 COMPLEMENTS / UNDERHAND AND DESK SET
 COMPLÉMENTS / SOUS MAIN ET SET DE BUREAU

IT— SKIN è un sottomano in cuoietto rigenerato per scrivanie. Semplice ed elegante, con cuciture in rilievo e un fondo antiscivolo che lo mantiene in posizione. Disponibile in quattro tonalità: bianco, nero, basalto, testa di moro e cuoio. SOPHIE è un set scrivania composto da cinque elementi: vassoio, porta penne, porta oggetti, porta biglietti da visita e vaso mono fiore. Ogni pezzo è originale e interamente fatto a mano in terracotta smaltata con effetto opaco mono e bicolore.

EN— SKIN is a regenerated leather underhand for desks. Simple and elegant, with embossed stitching and a non-slip bottom that keeps it in place. Available in four colours: white, black, basalt, dark brown and cuoio. SOPHIE is a set of five elements: tray, pen holder, object holder, visiting card holder and single-flower vase. Each piece is original and exclusive, made entirely by hand in matte glazed one or two-colour terracotta.

F— SKIN est un sous-main en cuir régénéré pour les bureaux. Simple et élégant, avec des surpiqûres en relief et un fond antidérapant qui le maintient en place. Disponible en quatre teintes: blanc, noir, basalte, brun foncé et cuir. SOPHIE est une set de bureau avec cinq pièces: un plateau, un porte-stylos, un porte-objet, un porte-cartes de visite et un vase mono-fleur. Chaque pièce est originale et entièrement réalisée à la main en terre cuite émaillée, effet mat monochrome ou deux tons.

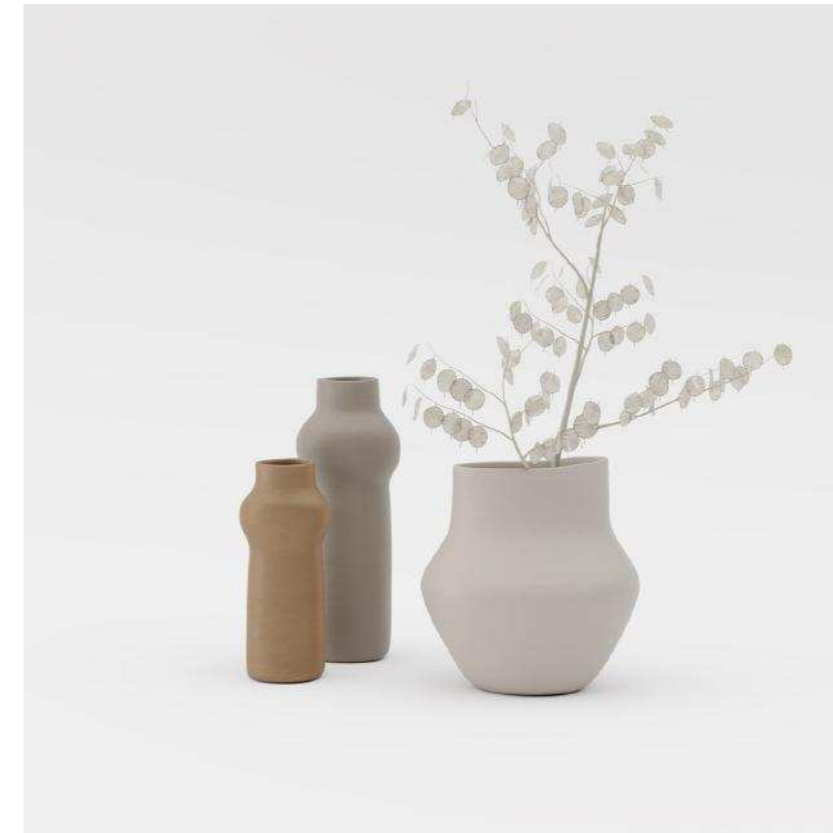
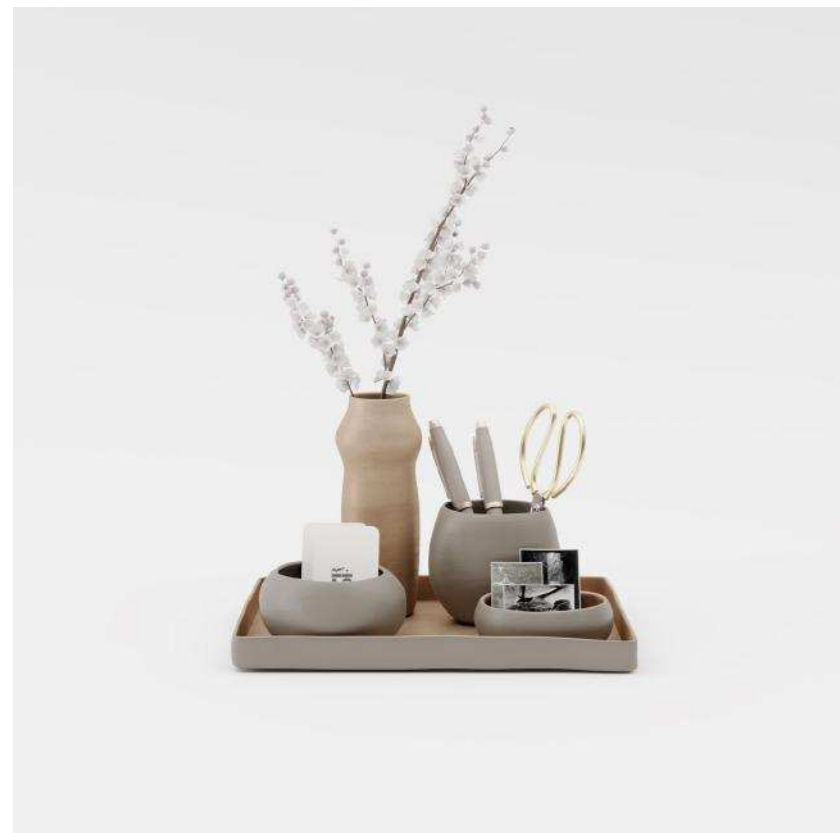

COMPLEMENTI / VASI
 COMPLEMENTS / VASES
 COMPLÉMENTS / VASES

IT— OLIVIA, INGRID e BLOOM sono set di vasi e ciotole fatti interamente a mano in terracotta smaltata con effetto opaco.

EN— OLIVIA, INGRID and BLOOM are set of vases and bowls made entirely by hand in matte glazed terracotta.

F— OLIVIA, INGRID et BLOOM sont set de vases boules fabriquées à la main en terre cuite émaillée effet mat.



creative & design direction
RMDESIGNSTUDIO / Mariella Vidotti

graphic design & copywriting
RMDESIGNSTUDIO

product design
R&S PROF

photos
concept, set design & styling / RMDESIGNSTUDIO
rendering & styling / SALAPOSA STUDIO

Digital preview
September 2021

L'azienda si riserva in qualunque momento di apportare senza preavviso modifiche a prodotti, accessori e finiture.

The Manufacturer reserves the right to modify products, accessories and finishings at any time without prior notice.

La Société se réserve le droit à tout moment de faire des changements sans préavis aux produits, accessoires et finitions.

Prof srl - Azienda certificata / Certified Company / Entreprise certifiée



PROF

PROF srl
Via Cao de Villa 6/A
Località Falzè di Piave
31020 Sernaglia della Battaglia, TV / Italy
T +39 0438 903190 F +39 0438 903228
p.iva / cod.fisc IT03134570260
www.profoffice.it info@profoffice.it

